

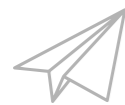

# Historia . History

## 1949-2025

1949



**1949**

En 1949, Marcos Larrañaga Chinchurreta fundó la empresa "Manufacturas Metálicas Marcos Larrañaga" en un pequeño local del centro de Bergara.

In 1949, Marcos Larrañaga Chinchurreta founded the company Manufacturas Metálicas Marcos Larrañaga in small premises in the centre of Bergara.

**1950**

Comenzamos a fabricar en aluminio los artículos para uso doméstico y material de ortodoncia para empresas de la comarca del Alto Deba en Gipuzkoa.

We started manufacturing aluminium household items and orthodontic materials for companies in the Alto Deba region in Gipuzkoa.

1950



**1960**

Trasladamos y ampliamos las instalaciones para poder fabricar menaje de aluminio para el sector de la hostelería y, posteriormente, comenzamos a fabricar las primeras piezas de acero inoxidable para el hogar. Asimismo, decidimos crear la marca comercializadora "Lacor" en honor al matrimonio que formaban el fundador Marcos Larrañaga y su mujer Casimira Cortabarría.

We moved and expanded our facilities in order to manufacture aluminium kitchenware for the hotel and catering industry and then started to manufacture the first stainless steel household articles. We also decided to create the brand name "Lacor" in honour of the married couple formed by the founder, Marcos Larrañaga, and his wife, Casimira Cortabarría.

**1970**

Mejoramos las piezas de acero inoxidable incluyendo el fondo difusor, además de ampliar la gama para el sector profesional. Comenzamos a exportar nuestros productos a los países contiguos Francia y Portugal.

We improved the stainless steel items by including a heat-diffusing bottom, as well as extending the professional kitchenware range. We started exporting our products to the neighbouring countries of France and Portugal.

1960



1970



1980



**1980**

Nos convertimos en el primer fabricante nacional de menaje en grandes dimensiones de acero inoxidable con fondo difusor y de una sola pieza. Así, tuvimos que volver a trasladar y ampliar las instalaciones actuales de Bergara, además de automatizar la producción. Seguimos trabajando para ampliar el catálogo profesional y conseguimos expandir las ventas a los 5 continentes.

We became the first national manufacturer of large single piece stainless steel kitchenware featuring a heat-diffusing bottom, so we had to relocate and expand the current facilities in Bergara, as well as automate production. We continuously strived to expand our professional portfolio and managed to increase sales to 5 continents.

**2000**

Creamos la empresa "Logística del Menaje" en Alegría-Dulantzi (10.000 m2) con su posterior ampliación hasta los 30.000 m2 para almacenar y gestionar los centenares de pedidos diarios de nuestros clientes. Igualmente, invertimos en las automatizaciones y robotizaciones en la producción para optimizar los recursos y mejorar el acabado de las piezas.

We created the company Logística del Menaje in Alegría-Dulantzi (10,000m2), followed by a subsequent extension to 30,000 m2 to store and manage the hundreds of daily orders from our customers. We also invested in production automation and robotisation to optimise resources and improve finishing of parts

2000



2025...

**2025...**

Nos consolidamos como marca líder de menaje profesional para hostelería y restauración.

Nuestros productos se caracterizan por el diseño, la calidad y la durabilidad, atributos que día a día conquistan a grandes chefs de todo el mundo.

Tratamos de contribuir a una sociedad saludable y sostenible. Promovemos el aprendizaje y el desarrollo de hábitos de vida saludables incorporando al catálogo materiales seguros y libre de tóxicos.

We have now consolidated our position as a leading brand in professional kitchenware for the hotel and catering industry.

Our products are well-known for their design, quality and durability, features that convince top chefs from all over the world on a daily basis.

We do our best to contribute to a healthy, sustainable society and promote learning and the development of a healthy lifestyle by including safe, toxic-free materials in our catalogue.

# Sostenibilidad

## Sustainability



**Nuestra responsabilidad va más allá de ofrecer menaje de alta calidad: buscamos cuidar de las personas y del planeta. Por eso, nuestros productos están fabricados con materiales libres de tóxicos, siendo seguros para tu salud y para el medio ambiente.**

**A su vez, hemos dado un paso firme en la reducción del plástico en nuestros embalajes, contribuyendo a minimizar los residuos y a proteger nuestro entorno.**

**Además, apostamos por la eficiencia energética con nuestra propia instalación de placas solares, que nos permite avanzar hacia la autosuficiencia energética y reducir nuestra huella de carbono.**

**Cada acción cuenta y cada producto que creamos refleja nuestro compromiso: un menaje de calidad, responsable y pensado para un mundo más sostenible.**

Our responsibility goes beyond offering high quality kitchenware: we seek to take care of people and the planet. That's why our products are made from toxic-free materials, making them safe for your health and for the environment.

At the same time, we have taken a firm step towards reducing the use of plastic in our packaging, helping to minimise waste and protect our environment.

We are also committed to energy efficiency with our own solar panel installation, which allows us to move towards energy self-sufficiency and reduce our carbon footprint.

Every action counts and every product we create reflects our commitment: quality, responsible kitchenware designed for a more sustainable world.



# Nuestros valores

## Nos valeurs · Our values

**L**iderazgo  
Leadership  
Leadership

**Somos una marca referencia dentro del sector de la hostelería y menaje doméstico. Tras años de esfuerzo nos hemos ganado una posición de liderazgo y nos hemos convertido en un referente en el sector.**

Nous sommes une marque de référence dans le secteur de l'hôtellerie et des ustensiles de cuisine. Après des années d'efforts, nous avons acquis une position de leadership et sommes devenus une référence dans le secteur.

We're a leading brand in the hospitality and home kitchenware industries. After years of effort we've earned a leadership position and we're at the forefront of the sector.

**A**mbición  
Ambition  
Ambition

**Estamos presentes en 90 países a lo largo de los 5 continentes. A través del esfuerzo de nuestros distribuidores, hemos conseguido llegar a las cocinas profesionales y hogares de todo el mundo.**

Nous sommes présents dans 90 pays situés sur 5 continents. Grâce à l'effort de nos distributeurs, nous sommes parvenus à rentrer dans les cuisines professionnelles et les foyers du monde entier.

We're present in 90 countries on 5 continents. Through the effort of our distributors we've been able to reach homes and professional kitchens around the world.

**C**ompromiso  
Engagement  
Commitment

**Integramos la cultura de la calidad tanto en los procesos de fabricación y productos como en la relación con nuestros clientes y colaboradores.**

Nous intégrons la culture de la qualité aussi bien dans les processus de fabrication et les produits que dans la relation avec nos clients et nos collaborateurs.

We have assimilated the culture of quality in both our manufacturing processes and products and our relationships with clients and collaborators.

**O**rganización  
Organisation  
Organization

**Pertenece a una tierra de profundas raíces gastronómicas donde nuestros artesanos comenzaron a fabricar las primeras cacerolas hace 75 años. Hoy en día mantenemos el mismo espíritu y pasión por nuestra propia historia.**

Nous sommes issus d'une région possédant de profondes racines gastronomiques où nos artisans ont commencé à fabriquer les premières casseroles il y a 75 ans. Aujourd'hui, nous avons gardé le même état d'esprit et la même passion pour notre propre histoire.

We belong to a land with deep gastronomical roots where our artisans began to make the first casseroles 75 years ago. Today, we still have the same spirit and passion for our history.

**R**esponsabilidad  
Responsabilité  
Responsibility

**Contamos con un equipo cualificado de personas con un alto grado de responsabilidad hacia el servicio. Gracias a la dedicación diaria, hemos conseguido establecer relaciones duraderas y de confianza con nuestros clientes.**

Nous bénéficions d'une équipe de personnes qualifiées avec un haut niveau de responsabilité vis-à-vis du service. Grâce à leur dévouement quotidien, nous avons pu établir des relations durables et de confiance avec nos clients.

We have a qualified team of people with a high degree of responsibility towards service. Thanks to our day in day out dedication, we've been able to build long lasting and trusting relationships with our clients.



# Conócenos

Connais-nous · Know us

## Fábrica

Usine · Factory

### · Fábrica ubicada en Bergara (España)

· Usine située en Bergara (Espagne)

· Factory located in Bergara (Spain)



## Almacén

Entrepôt · Warehouse

### · Almacén de 30.000 m2 · Capacidad: 42.000 pallets

· Entrepôt de 30.000 m2 · Capacité: 42.000 pallets

· Warehouse 30.000 m2 · Capacity: 42.000 pallets



## Distribuidores

Distributeurs · Distributors

### · Más de 3200 distribuidores · Presentes en 90 países

· Plus de 3200 distributeurs · Présent dans 90 pays

· More than 3200 distributors · Present in 90 countries



# Worldwide

## Europe

Andorra · Austria · Belgium · Bulgaria · Czech Republic · Croatia · Cyprus · Denmark · Finland · France · Germany · Greece · Holland · Hungary · Iceland · Ireland · Italy · Latvia · Lithuania · Luxembourg · Macedonia · Montenegro · Poland · Portugal · Romania · Russia · Serbia · Slovenia · Spain · Sweden · Switzerland · Turkey · UK+ N. Ireland · Ukraine

## America

Argentina · Bolivia · Brazil · Canada · Chile · Colombia · Costa Rica · Cuba · Dominican Rep. · French Guayana · Guadalupe · Guatemala · Honduras · Jamaica · Martinique · Mexico · Paraguay · Peru · United States · Uruguay

## Asia

Azerbaijan · Cambodia · China · Hong Kong · India · Indonesia · Iran · Iraq · Israel · Japan · Jordan · Kazakhstan · Kuwait · Lebanon · Macau · Malaysia · Philippines · Qatar · Russia · Saudi Arabia · Singapore · South Korea · Sri Lanka · Taiwan · Thailand · UAE · Vietnam

## Africa

Algeria · Burkina Faso · Cape Verde · Egypt · Ethiopia · Ivory Coast · Kenya · Libya · Mauricio · Morocco · Reunion Island · Senegal · Seychelles · South Africa · Tunisia

## Oceania

Australia · New Zeland



# Leyenda Materiales

















Légende · Legend Matériaux · Materials

<b>A</b>	<b>Acacia</b> Bois d'acacia Acacia wood	<b>Acacia</b> Wood
	<b>Acero cromado</b> Acier chromé Chrome steel	<b>Acero Cromado</b> Chrome sell
	<b>Acrílico</b> Acrylique Acrylic	<b>ASA</b> Acrylic
	<b>Acrlonitrilo butadieno estireno (termoplástico)</b> Acrylonitrile Butadiène Styrene (Thermoplastique) Acrylonitrile Butadiene Styrene (Thermoplastic)	<b>ABS</b> Plastic
	<b>Aluminio</b> Aluminium Aluminium	<b>AL</b> Aluminium
<b>B</b>	<b>Bambú</b> Bois de bambou Bamboo wood	<b>Bambú</b> Bamboo
<b>C</b>	<b>Caucho termoplástico</b> Caoutchouc thermoplastique Thermoplastic rubber	<b>TPR</b> Plastic
	<b>Cerámico</b> Céramique Ceramic	<b>CE</b> Ceramic
	<b>Cristal</b> Verre Glass	<b>Cristal</b> Glass
<b>E</b>	<b>Elastómero termoplástico</b> Élastomère thermoplastique Thermoplastic elastomer	<b>TPE</b> Plastic
<b>F</b>	<b>Fibra de vidrio</b> Fibre de verre Fiberglass	<b>Fibra de vidrio</b> Fiberglass
	<b>Forjado</b> Forgée Wrought	<b>FO</b> Forjado Wought
	<b>Fundido</b> Fondu Cast	<b>FU</b> Fundido Cast
<b>H</b>	<b>Haya</b> Bois de hêtre Beech wood	<b>Haya</b> Beech Wood
	<b>Hierro</b> Fer Iron	<b>FE</b> Iron
	<b>Hierro colado</b> Fonte Cast iron	<b>Hierro colado</b> Cast iron
<b>I</b>	<b>Inoxidable</b> Acier inoxydable Stainless steel	<b>Inox</b>
	<b>Inoxidable 18/10</b> Acier inoxydable 18/10 Stainless steel 18/10	<b>Inox 18/10</b>

<b>M</b>	<b>Madera de caucho</b> Bois de caoutchouc Rubber wood	<b>Madera Caucho</b> Rubber wood
	<b>Material embutido</b> Matériel d'incrustation Inlaying material	<b>Embutición</b> Deep Drawn
	<b>Melamina (trímero)</b> Mélamine (trimère) Melamine (trimer)	<b>MF</b> Melamine
<b>N</b>	<b>Nylon</b> Nylon Nylon	<b>PA</b> Nylon
<b>P</b>	<b>Pizarra natural 100%</b> 100% ardoise naturelle 100% natural Slate	<b>Pizarra</b> Slate
	<b>Plástico estireno acrilonitrilo</b> Plastique acrylonitrile styrène Acrylonitrile styrene plastic	<b>SAN</b> Plastic
	<b>Plástico polimetilmetacrilato</b> Plastique polyméthacrylate de méthyle Polymethyl methacrylate plastic	<b>PMMA</b> Plastic
	<b>Policarbonato</b> Polycarbonate Polycarbonate	<b>PC</b> Polycarbon
	<b>Poliestireno (polímero termoplástico)</b> Polystyrène (polymère thermoplastique) Polystyrene (thermoplastic polymer)	<b>PS</b> Plastic
	<b>Poliétileno (polímero)</b> Polyéthylène (polymère) Polyethylene (polymer)	<b>PE</b> Polyethylene
	<b>Poliétileno de alta densidad (polímero)</b> Polyéthylène haute densité (polymère) High-density polyethylene (polymer)	<b>HPPE</b> Polyethylene
	<b>Poliétileno de baja densidad (polímero)</b> Polyéthylène basse densité (polymère) Low density polyethylene (polymer)	<b>PELD</b> Polyethylene
	<b>Poliétileno de baja densidad (polímero)</b> Polyéthylène basse densité (polymère) Low density polyethylene (polymer)	<b>LDPE</b> Polyethylene
	<b>Polipropileno (polímero)</b> Polypropylène (polymère) Polypropylene (polymer)	<b>PP</b> Polypropilene
<b>S</b>	<b>Silicona</b> Silicone Silicone	<b>Si</b> Silicone
<b>Z</b>	<b>ZAMAK</b> ZAMAK ZAMAK	<b>Zinc Alloy</b>
	<b>Zirconia</b> Zircone Zirconia	<b>CZ</b> Zirconia

# Leyenda Características

Légende · Legend Caractéristiques · Characteristics

<b>A</b>	<b>Anodizado</b> Anodisé Anodized	
	<b>Antiadherente libre de PFOA</b> Antiadhésif sans PFOA PFOA free non-stick	
	<b>Antiadherente</b> Antiadhésif Non-stick	
	<b>Apto para el lavavajillas</b> Lave-vaisselle Dishwasher safe	
	<b>Apto para llama</b> Convient pour la flamme Suitable for flame	
	<b>Apto para el congelador</b> Va au congélateur Freezer safe	
	<b>Apto para el horno</b> Va au four Oven safe	
	<b>Apto para el microondas</b> Va au micro-ondes Microwave safe	
	<b>Artículo apilable</b> Article empilable Stackable item	
<b>C</b>	<b>Certificado de Conformidad Europea</b> Certificat de conformité européen European Certificate of Conformity	
	<b>Certificado en gestión forestal y cadena de custodia</b> Certifié en gestion forestière et chaîne de contrôle Certified in forest management and chain of custody	
	<b>Certificado ISO 14001. Sist. de gestión ambiental</b> Certificat ISO 14001. Syst. gestion environnementale ISO 14001 certificate. Syst. environmental management	
	<b>Cocina eléctrica</b> Cuisinier électrique Electric cook	
	<b>Cocina de gas</b> Cuisinière à gaz Gas cook	
	<b>Cocina de inducción</b> Cuisinier à induction Induction cook	
	<b>Cocina vitrocerámica</b> Cuisinier vitrocéramique Vitroc ceramic cook	
	<b>Cocina saludable</b> Cuisine saine Healthy cooking	



Todo aquel icono de la lista de la leyenda que contenga un aspa en rojo significa que no es apto. Toute icône de la liste contenant une croix rouge signifiera qu'elle ne lui convient pas. Jedes Symbol in der Legendenliste, das ein rotes Kreuz enthält, bedeutet, dass es nicht dafür geeignet ist. Any icon in the legend list that contains a red cross will mean that it is not suitable for it. Qualquer ícone na lista de legendas que contenha uma cruz em vermelho, significa que não é adequado.

<b>D</b>	<b>Directiva 2011/65/UE de Restricción de ciertas Sust. Peligrosas</b> Directive 2011/65 / UE sur les restrictions de certaines substances dangereuses Directive 2011/65 / EU on Rest. of Certain Hazardous substances	
	<b>Dureza del artículo</b> Dureté de l'article Item Hardness	<b>87</b> HRc
<b>E</b>	<b>Etiqueta ecológica para productos textiles</b> Label écologique pour les produits textiles Eco label for textile products	
<b>F</b>	<b>Fondo sandwich</b> Fond de sandwich Sandwich background	
<b>L</b>	<b>Lavar con un trapo húmedo</b> Laver avec un chiffon humide Wash with a damp cloth	
	<b>Libre de BPA</b> Sans BPA BPA free	
<b>M</b>	<b>Material blando y flexible</b> Matériau souple et flexible Soft and flexible material	
	<b>Material ecológico</b> Matériel écologique Ecological material	
	<b>Motor de corriente alterna</b> Moteur à courant alternatif Alternating current motor	
	<b>Motor de corriente continua</b> Moteur à courant continu Continuous current motor	
<b>N</b>	<b>Nivel de protección al polvo y agua</b> Niveau de protection contre la poussière et l'eau Dust and water protection level	<b>IP20</b>
	<b>Nivel de temperatura máxima</b> Niveau de température maximum Maximum temperature level	<b>200°C</b> max
	<b>Nº de capas del antiadherente</b> Nombre de couches antiadhésives No. of non-stick layers	<b>3</b> Capas/Layer
	<b>Nº de hojas que tiene el portamenu</b> Nombre de feuilles dans le support de menu Number of sheets in the menu holder	<b>6/4/4</b>
	<b>Normas creadas por Comités Técnicos de Normalización de la Asociación Española</b> Normes créées par les comités de normalisation technique de l'Association espagnole Standards created by the Technical Standardization Committees of the Spanish Association	
<b>P</b>	<b>Peso que puede aguantar el artículo</b> Poids que l'article peut contenir Weight the item can hold	<b>120 Kg</b>
	<b>Prohibido transportar en avión</b> Interdit de transporter en avion Forbidden to transport by plane	

# Novedades

## Nouvelles · Novelties



**Batería Gastro**  
Battery  
« 29 »



**Set 3 cazos Combi**  
Set 3 saucepans + handle  
« 35 »



**Cuscusera**  
Couscous maker  
« 55 »



**Wok Foodie**  
Wok  
« 39/103 »



**Crepera Foodie**  
Crepiere  
« 39/103 »



**Batería Caliza**  
Battery  
« 52 »



**Bandeja oval MAGMA**  
Oval tray  
« 67/251 »



**Sartén Garinox**  
Frying-pan  
« 82 »



**Crepera Ferrum**  
Crepiere  
« 89 »



**Sartén Kale**  
Frying-pan  
« 90 »



**Sartenes Cuisine**  
Frying pans  
« 104 »



**Llauna de arroz**  
Rice launa  
« 113 »



**Bandeja con rejilla Essential**  
Tray with rack  
« 113 »



**Colección Aqua Garinox**  
Aqua Garinox Collection  
« 131 »



**Cacillo Select**  
Ladle  
« 135 »



**Embudo Dosificador**  
Embudo Dosificador  
« 150 »



**Colección Smart**  
Smart Collection  
« 162 »



**Tapete microperforado White**  
Micro-perforated mat  
« 117/350 »



**Espátula acodada**  
Angled spatula  
« 135 »



**Escurreidor Inox**  
Straine  
« 148 »



**Prensa ajos Dual**  
Garlic press  
« 156 »



**Organizadores Organizer**  
Organisers Organizer  
« 163 »



**Guante de cocina Vichy y Black**  
Kitchen glove  
« 118 »



**Set de 3 utensilios**  
Set of 3 utensils  
« 135 »



**Escurreidor plegable**  
Folding strainer  
« 148 »



**Prensador carne Magma**  
Meat press  
« 159 »



**Recipiente rectangular Ecolnox/Etern**  
Rectangular container  
« 179/180 »



**Recipiente TwoGo**  
Container ·  
« 181 »



**Báscula plataforma**  
Platform scale  
« 182 »



**Báscula digital ultraprecisión Doble**  
High precision dual platform digital scales ·  
« 184 »



**Báscula con bol Just**  
Scales with bowl ·  
« 184 »



**Báscula de baño Silver**  
Bathroom scales  
« 187 »



**Rallador Cónico**  
Conical grater  
« 201 »



**Melamina**  
Melamine  
« 241/242 »



**Wood Collection**  
Colección Madera  
« 244 »



**Mini cocotte Serve**  
Mini cocotte  
« 246 »



**Set 3 ramequines**  
Set of 3 ramekins  
« 253 »



**Bandeja Share**  
Tray  
« 253 »



**Bandeja Olive**  
Tray  
« 253 »



**Mandolina vertical Plus**  
Vertical mandoline  
« 202 »



**Mandolina bidireccional Fast**  
Dual slice mandoline  
« 203 »



**Colección Select**  
Select Collection  
« 208 »



**Encendedores de gas**  
Gas lighter  
« 262 »



**Molinillo Black**  
Grinder  
« 266 »



**Cascanueces Wood**  
Nut Cracker  
« 272 »



**Set de cuchillos Monoblock**  
Micro serrated knife set  
« 216 »



**Bloque magnético Magnet**  
Magnetic block Magnet  
« 219 »



**Afilador de precisión 6 en 1**  
Precision sharpener  
« 220 »



**Mantel individual Oval**  
Oval individual placemat  
« 275 »



**Vaso termo Ocean**  
Thermo tumbler  
« 282 »



**Cafetera automática Sabore**  
Automatic coffee machine  
« 286/528 »



**Afilador de cuchillos Drei**  
Knife sharpener  
« 221/559 »



**Tabla de corte para pan GN 1/1**  
Bread cutting board GN 1/1  
« 222 »



**Organizador Compact**  
Compact Organiser  
« 226 »



**Cafetera Francesa Inox**  
French coffee maker inox  
« 289 »



**Lecheras White**  
Milk jug · Leitera barista  
« 292 »



**Soporte de copas Due**  
Cups stand  
« 304 »



**Vaso Julep Mug**  
Tumbler

<< 306 >>



**Cortapastas extensible rizado**  
Dough divider expandable

<< 331 >>



**Sopletes de gas/Cartucho de gas**  
Gas torch /Gas cartridge

<< 334/335 >>



**Batidora Provite**  
Mixer

<< 477 >>



**Deshidratador de alimentos Dry**  
Food dehydrator

<< 487 >>



**Freidora eléctrica Intact/Vue**  
Electric fryer

<< 491 >>



**Porta menú Saura**  
Menu cover

<< 370 >>



**Porta menú Simone**  
Menu cover

<< 371 >>



**Porta menú Bosco**  
Menu cover

<< 371 >>



**Horno pizza Lecco**  
Pizza oven

<< 498 >>



**Plancha grill Due**  
Grill plate

<< 504 >>



**Cafetera de goteo Drop**  
Filter coffee machine

<< 526 >>



**Chafing Dish Noir**  
Chafing Dish Noir

<< 390 >>



**Cubetas Inducción**  
Induction Cookware

<< 395 >>



**Degustare Transparent**  
Bolform Blume

<< 397 >>



**Máquina de vacío Ingenious**  
Vacuum machine Ingenious

<< 543 >>



**Sous Vide Master**  
Sous Vide

<< 546 >>



**Mini bar Vista**  
Mini-bar refrigerator

<< 553 >>



**Bandeja**  
Tray

<< 399 >>



**Buffet Nord**  
Buffet

<< 400 >>

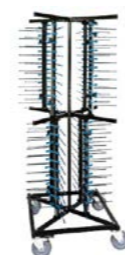

**Carro portaplatos**  
Plate trolley

<< 429 >>



**Matamosquitos Limpo**  
Electric mosquito killer

<< 562 >>



**Bandeja Servicio Red**  
Service Tray Network

<< 431 >>



**Máquina de helados Artic**  
Ice cream machine

<< 462 >>



**Batidoras Rapid**  
Blenders

<< 473 >>

Descubre más...  
En savoir plus · Find out more



# Índice • Index



## 01

### Menaje Cookware

**20**  
**Baterías profesionales**  
Professional cookware

**33**  
**Baterías domésticas**  
Household cookware

**70**  
**Ollas a presión**  
Pressure cooker

**79**  
**Sartenes**  
Frypans

16

## 02

### Utensilios Utensils

**126**  
**Juegos de cocina**  
Kitchen tools

**137**  
**Preparación**  
Food processing

**174**  
**Medir y pesar**  
Measuring and weighing

**190**  
**Corte**  
Cutting

## 03

### Mesa Table Top

**230**  
**Bandejas y fuentes**  
Trays and platters

**233**  
**Melamina**  
Melamine

**245**  
**Servicio mesa**  
Table service

**274**  
**Manteles y salvamanteles**  
Tablecloths and placemats

**278**  
**Termos y botellas**  
Thermos · bottles

**283**  
**Cafetería**  
Coffee

**294**  
**Bar bodega**  
Wine cellar

## 04

### Repostería Pastry-making

**318**  
**Utensilios y preparación**  
Pastry processing

**344**  
**Moldes y aros**  
Moulds and rings

## 05

### Restauración Restoration

**362**  
**Porta menú y pizarras**  
Portamenu y blackboards

**383**  
**Buffet**  
Buffet

**417**  
**Cubetas**  
Container

**420**  
**Transporte y almacenamiento**  
Transport and Shelves

## 06

### Eléctrico Electric

**454**  
**Eléctrico**  
Electric



17

01

**Menaje**  
Cookware





## Chef Luxe



- **Toda la pieza (cuerpo, asas y mangos) fabricada en acero inoxidable 18/10.**
- **Fondo termodifusor (inox 18/10 - aluminio - inox).**
- **Espesor 1,5 - 2 mm.**
- **Tapas diseñadas para el ahorro energético.**
- **Máxima garantía en cuanto a resistencia, durabilidad e higiene.**
- **Apta para todos los tipos de cocina (incluida inducción y horno).**

- **Toute la pièce (corps, poignées et manches) est fabriquée en acier inoxydable 18/10.**
- **Fond thermo-diffuseur (Inox 18/10 - Aluminium - Inox).**
- **Épaisseur 1,5 - 2 mm.**
- **Couvercles conçus pour une économie d'énergie.**
- **Garantie maximale en termes de résistance, de durabilité et d'hygiène.**
- **Compatible avec tous les types de cuisinières (et compris induction et four).**

- **The whole product (body, handles and grips) is made in 18/10 stainless steel.**
- **Heat diffuser bottom (18/10 stainless steel - Aluminium - Stainless).**
- **Thickness 1.5 - 2 mm.**
- **Covers designed for saving energy.**
- **Maximum guarantee in terms of resistance, durability and hygiene.**
- **Suitable for all types of cooking surfaces (including induction and the oven).**



### Cacerola con tapa

Faitout avec couvercle · Bratentopf mit Deckel  
Casserole with lid · Caçarola com tampa

Ref	€	Ø (cm)	h(cm)	e (mm)	L	U.Venta
54020	85,60	20	10,0	1,5	2,90	1
54024	102,50	24	11,0	1,5	4,25	1
54028	118,80	28	11,0	1,5	6,70	1
54032	148,10	32	12,5	1,5	10,00	1
54036	179,50	36	14,0	1,5	14,20	1
54040	232,80	40	15,5	2,0	19,40	1
54045	276,80	45	17,0	2,0	27,00	1
* 54050	347,10	50	20,0	2,0	38,20	1

\* **NO inducción** · NON induction · NOT Induction

### Cacerola sin tapa

Faitout sans couvercle · Bratentopf ohne Deckel  
Casserole without lid · Caçarola sem tampa

Ref	€	Ø (cm)	U.Venta
54020S	67,70	20	1
54024S	82,00	24	1
54028S	95,50	28	1
54032S	119,50	32	1
54036S	144,90	36	1
54040S	193,80	40	1
54045S	232,00	45	1
* 54050S	293,90	50	1

\* **NO inducción** · NON induction · NOT Induction



### Cacerola alta con tapa

Braisiere avec couvercle · Fleischtopf mit Deckel  
Deep casserole with lid · Caçarola alta com tampa

Ref	€	Ø (cm)	h(cm)	e (mm)	L	U.Venta
54021	89,40	20	13,0	1,5	4,00	1
54025	111,30	24	14,0	1,5	6,70	1
54029	135,50	28	17,5	1,5	10,70	1
54033	158,30	32	18,0	1,5	14,60	1
54037	201,90	36	21,5	1,5	21,80	1
54041	262,80	40	24,5	2,0	30,00	1
54046	311,90	45	27,5	2,0	43,70	1
* 54051	411,50	50	30,0	2,0	58,80	1

\* **NO inducción** · NON induction · NOT Induction



### Olla recta con tapa

Marmite traiteur avec couvercle · Suppentopf mit Deckel  
Casserole with lid · Caçarola com tampa

Ref	€	Ø (cm)	h(cm)	e (mm)	L	U.Venta
54120	99,10	20	20,0	1,5	6,20	1
54124	120,90	24	24,0	1,5	10,50	1
54128	146,00	28	28,0	1,5	17,20	1
54132	198,10	32	32,0	1,5	25,70	1
54136	245,10	36	36,0	1,5	36,50	1
54140	305,40	40	40,0	2,0	50,00	1
54145	390,80	45	45,0	2,0	71,50	1
* 54150	551,90	50	50,0	2,0	98,00	1

\* **NO inducción** · NON induction · NOT Induction



### Olla baja con tapa

Marmite basse avec couvercle · Gemüsetopf mit Deckel  
Low casserole with lid · Caçarola baixa com tampa

Ref	€	Ø (cm)	h(cm)	e (mm)	L	U.Venta
54119	93,30	20	15,0	1,5	4,70	1
54123	113,60	24	20,0	1,5	9,00	1
54127	142,00	28	22,0	1,5	13,50	1
54131	186,10	32	26,0	1,5	20,00	1
54135	209,30	36	29,0	1,5	29,50	1
54139	285,80	40	32,0	2,0	40,00	1



### Cacerola alta sin tapa

Braisiere sans couvercle · Fleischtopf ohne Deckel  
Deep casserole without lid · Caçarola alta sem tampa

Ref	€	Ø (cm)	U.Venta
54021S	71,50	20	1
54025S	90,80	24	1
54029S	112,20	28	1
54033S	129,70	32	1
54037S	167,30	36	1
54041S	223,80	40	1
54046S	267,10	45	1
* 54051S	358,30	50	1

\* **NO inducción** · NON induction · NOT Induction



### Olla recta sin tapa

Marmite traiteur s/couvercle · Suppentopf ohne Deckel  
Stock Pot without lid · Panela sem tampa

Ref	€	Ø (cm)	U.Venta
54120S	81,20	20	1
54124S	100,40	24	1
54128S	122,70	28	1
54132S	169,50	32	1
54136S	210,50	36	1
54140S	266,40	40	1
54145S	346,00	45	1
* 54150S	498,70	50	1

\* **NO inducción** · NON induction · NOT Induction



### Olla baja sin tapa

Marmite basse s/couvercle · Gemüsetopf ohne Deckel  
Low stock pot without lid · Panela baixa sem tampa

Ref	€	Ø (cm)	U.Venta
54119S	75,40	20	1
54123S	93,10	24	1
54127S	118,70	28	1
54131S	157,50	32	1
54135S	174,70	36	1
54139S	246,80	40	1



### Paellera con tapa

Plat rond avec couvercle · Pfanne mit Deckel  
Round dish with lid · Paelheira com tampa

Ref	€	Ø (cm)	h(cm)	e (mm)	L	U.Venta
54636	<b>174,10</b>	36	7,0	1,5	7,00	1
54640	<b>211,90</b>	40	8,0	1,5	10,00	1
54645	<b>245,40</b>	45	8,5	2,0	12,00	1
* 54650	<b>309,70</b>	50	9,0	2,0	17,00	1

\* **NO inducción** · NON induction · NOT Induction



### Paellera sin tapa

Plat rond s/couvercle · Pfanne ohne Deckel  
Round dish without lid · Paelheira sem tampa

Ref	€	Ø (cm)	U.Venta
54636S	<b>137,80</b>	36	1
54640S	<b>170,80</b>	40	1
54645S	<b>198,30</b>	45	1
* 54650S	<b>253,50</b>	50	1

\* **NO inducción** · NON induction · NOT Induction



### Cazo

Casserole · Stielkasserolle, flach  
Saucepan · Caçarola direite

Ref	€	Ø (cm)	h(cm)	e (mm)	L	U.Venta
54212	<b>44,20</b>	12	7,0	1,2	0,75	1
54214	<b>46,70</b>	14	7,5	1,2	1,10	1
54216	<b>49,40</b>	16	8,0	1,5	1,60	1
54218	<b>54,10</b>	18	9,0	1,5	2,25	1
54220	<b>60,70</b>	20	10,0	1,5	2,90	1
* 54224	<b>79,90</b>	24	10,0	1,5	4,25	1
* 54228	<b>92,40</b>	28	11,0	1,5	6,70	1

\* **Con asa** · Avec poignée · With handle



### Cazo alto

Casserole haute · Stielkasserolle  
Deep saucepan · Caçarola alta direite

Ref	€	Ø (cm)	h(cm)	e (mm)	L	U.Venta
54217	<b>52,00</b>	16	11,0	1,5	2,20	1
54219	<b>60,80</b>	18	12,0	1,5	3,00	1
54221	<b>64,10</b>	20	13,0	1,5	4,00	1
* 54225	<b>91,50</b>	24	14,0	1,5	6,70	1
* 54229	<b>107,80</b>	28	17,5	1,5	10,70	1

\* **Con asa** · Avec poignée · With handle



### Cazo Francés

Casserole Française · Stielkasserolle, französisch  
French saucepan · Francês caçarola direite

Ref	€	Ø (cm)	h(cm)	e (mm)	L	U.Venta
54225N	<b>78,40</b>	24	12,0	1,5	5,40	1
54229N	<b>100,60</b>	28	14,0	1,5	8,60	1



### Cazo Cónico

Sautase conique · Sauteuse, Konisch  
Conical saute pan · Caçarola cónica

Ref	€	Ø (cm)	h(cm)	e (mm)	L	U.Venta
55216	<b>49,40</b>	16	6,0	1,5	1,00	1
55220	<b>54,50</b>	20	6,5	1,5	1,60	1
55224	<b>63,80</b>	24	7,5	1,5	2,70	1

### Tapa

Couvercle · Deckel  
Lid · Tampa

Ref	€	Ø (cm)	U.Venta
54916	<b>16,50</b>	16	1
54920	<b>17,90</b>	20	1
54924	<b>20,50</b>	24	1
54928	<b>23,30</b>	28	1
54932	<b>28,60</b>	32	1
54936	<b>34,60</b>	36	1
54940	<b>39,00</b>	40	1
54945	<b>44,80</b>	45	1
54950	<b>53,20</b>	50	1



### Sautex

Sauteuse · Sauteuse  
Sauté pan · Frigideira

Ref	€	Ø (cm)	h(cm)	e (mm)	L	U.Venta
* 54621	<b>59,00</b>	20	6,5	1,5	1,80	1
54625	<b>71,50</b>	24	6,5	1,5	2,70	1
54629	<b>87,90</b>	28	7,0	1,5	4,00	1
54633	<b>110,10</b>	32	8,5	1,5	4,70	1
54637	<b>132,70</b>	36	10,0	1,5	7,00	1

\* **Sin asa** · Sans poignée · Without handle



## Chef Classic

INOX 18/10



- **Toda la pieza (cuerpo, asas y mangos) fabricada en acero inoxidable 18/10.**
- **Fondo termodifusor (inox 18/10 - aluminio - inox).**
- **Espesor 0,7 - 1,2 mm.**
- **Tapas diseñadas para el ahorro energético.**
- **Apta para todos los tipos de cocina (incluida inducción y horno). \* Excepto Ø60 cm.**
- **Acabado mate interior y exterior.**
- **Máxima garantía en cuanto a resistencia, durabilidad e higiene.**

- Toute la pièce (corps, poignées et manches) est fabriquée en acier inoxydable 18/10.
- Fond thermo-diffuseur (Inox 18/10 - Aluminium - Inox).
- Épaisseur 0,7 - 1,2 mm.
- Couvercles conçus pour une économie d'énergie.
- Compatible avec tous les types de cuisinières (et compris induction et four). \* Excepté Ø60 cm.
- Finition mate intérieur et extérieur.
- Garantie maximale en termes de résistance, de durabilité et d'hygiène.

- The whole product (body, handles and grips) is made in 18/10 stainless steel.
- Heat diffuser bottom (18/10 stainless steel - Aluminium - Stainless).
- Thickness 0.7 - 1.2 mm.
- Covers designed for saving energy.
- Suitable for all types of cooking surfaces (including induction and the oven). \* Except Ø60 cm.
- Interior and exterior matte finish.
- Maximum guarantee in terms of resistance, durability and hygiene.



### Cacerola con tapa

Faitout avec couvercle · Bratentopf mit Deckel  
Casserole with lid · Caçarola com tampa

Ref	€	Ø (cm)	h(cm)	e (mm)	L	U.Venta
50016	<b>51,00</b>	16	8,0	0,7	1,60	1
50020	<b>60,70</b>	20	9,0	0,7	2,80	1
50024	<b>68,90</b>	24	9,5	0,8	4,25	1
50028	<b>95,40</b>	28	11,0	0,8	6,75	1
50032	<b>119,40</b>	32	12,5	0,8	10,00	1
50036	<b>159,90</b>	36	14,0	1,0	14,20	1
50040	<b>185,10</b>	40	15,5	1,0	19,40	1
50045	<b>218,10</b>	45	17,0	1,0	27,00	1
50050	<b>302,60</b>	50	20,0	1,0	38,20	1
* 50060	<b>431,10</b>	60	25,0	1,2	70,00	1

\* **NO inducción** · NON induction · NOT Induction



### Cacerola sin tapa

Faitout sans couvercle · Bratentopf ohne Deckel  
Casserole without lid · Caçarola sem tampa

Ref	€	Ø (cm)	U.Venta
50016S	<b>40,40</b>	16	1
50020S	<b>46,80</b>	20	1
50024S	<b>53,70</b>	24	1
50028S	<b>78,00</b>	28	1
50032S	<b>96,40</b>	32	1
50036S	<b>132,10</b>	36	1
50040S	<b>153,90</b>	40	1
50045S	<b>180,80</b>	45	1
50050S	<b>256,80</b>	50	1
* 50060S	<b>371,30</b>	60	1

\* **NO inducción** · NON induction · NOT Induction



### Cacerola alta con tapa

Braisiere avec couvercle · Fleischtopf mit Deckel  
Deep casserole with lid · Caçarola alta com tampa

Ref	€	Ø (cm)	h(cm)	e (mm)	L	U.Venta
50017	52,80	16	11,0	0,7	2,20	1
50021	65,30	20	13,0	0,7	4,00	1
50025	76,70	24	14,0	0,8	6,75	1
50029	99,10	28	17,5	0,8	10,00	1
50033	129,70	32	18,0	0,8	14,40	1
50037	174,30	36	21,5	1,0	21,80	1
50041	208,80	40	24,5	1,0	30,70	1
50046	243,10	45	27,5	1,0	43,70	1
50051	348,50	50	30,0	1,2	58,80	1
* 50061	490,40	60	35,0	1,2	98,00	1

\* NO inducción · NON induction · NOT Induction



### Cacerola alta sin tapa

Braisiere sans couvercle · Fleischtopf ohne Deckel  
Deep casserole without lid · Caçarola alta sem tampa

Ref	€	Ø (cm)	U.Venta
50017S	42,20	16	1
50021S	51,40	20	1
50025S	61,50	24	1
50029S	81,70	28	1
50033S	106,70	32	1
50037S	146,50	36	1
50041S	177,60	40	1
50046S	205,80	45	1
50051S	302,70	50	1
* 50061S	430,60	60	1

\* NO inducción · NON induction · NOT Induction



### Paellera con tapa

Plat rond a/couvercle · Pfanne mit Deckel  
Round with lid · Paelheira com tampa

Ref	€	Ø (cm)	h(cm)	e (mm)	L	U.Venta
50624	64,80	24	6,0	0,8	2,70	1
50628	87,70	28	6,0	0,8	3,60	1
50632	113,20	32	6,0	0,8	5,00	1
50636	143,40	36	7,0	1,0	7,10	1
50640	165,00	40	8,0	1,0	10,00	1
50645	193,80	45	8,5	1,0	13,50	1
50650	251,40	50	9,0	1,0	17,60	1
* 50660	363,40	60	9,0	1,0	25,40	1

\* NO inducción · NON induction · NOT Induction



### Paellera sin tapa

Plat rond s/couvercle · Pfanne ohne Deckel  
Round dish without lid · Paelheira sem tampa

Ref	€	Ø (cm)	U.Venta
50624S	49,60	24	1
50628S	70,30	28	1
50632S	90,20	32	1
50636S	115,60	36	1
50640S	133,80	40	1
50645S	156,50	45	1
50650S	205,60	50	1
* 50660S	303,60	60	1

\* NO inducción · NON induction · NOT Induction



### Olla recta con tapa

Marmite traiteur avec couvercle · Suppentopf mit Deckel  
Stock pot with lid · Panela com tampa

Ref	€	Ø (cm)	h(cm)	e (mm)	L	U.Venta
50116	56,60	16	16,0	0,8	3,20	1
50120	72,50	20	20,2	0,8	6,20	1
50124	91,00	24	24,0	0,8	10,50	1
50128	124,30	28	28,0	1,0	17,20	1
50132	176,20	32	32,0	1,0	25,70	1
50136	213,90	36	36,0	1,0	36,60	1
50140	255,60	40	40,0	1,2	50,00	1
50145	328,30	45	45,0	1,2	68,30	1
50150	514,40	50	50,0	1,2	98,00	1
* 50160	722,30	60	50,0	1,2	141,00	1

\* NO inducción · NON induction · NOT Induction



### Olla recta sin tapa

Marmite traiteur s/couvercle · Suppentopf ohne Deckel  
Stock Pot without lid · Panela sem tampa

Ref	€	Ø (cm)	U.Venta
50116S	46,00	16	1
50120S	58,60	20	1
50124S	75,80	24	1
50128S	106,90	28	1
50132S	153,20	32	1
50136S	186,10	36	1
50140S	224,40	40	1
50145S	291,00	45	1
50150S	468,60	50	1
* 50160S	662,50	60	1

\* NO inducción · NON induction · NOT Induction



### Cacerola Vapor

Panier vapeur · Dampfkoch-Aussatz o/Untertopf  
Steam casserole · Caçarola a vapor

Ref	€	Ø (cm)	h(cm)	e (mm)	U.Venta
50428	60,50	28	11,0	0,8	1
50432	66,80	32	12,5	0,8	1



### Sautex

Sauteuse · Sauteuse  
Sauteuse · Frigideira

Ref	€	Ø (cm)	h(cm)	e (mm)	L	U.Venta
50625	47,50	24	6,5	0,8	2,70	1
50629	65,50	28	7,0	0,8	4,00	1
50633	74,20	32	8,5	0,8	4,70	1
50637	106,90	36	10,0	1,0	7,00	1



### Olla baja con tapa

Marmite basse a/couvercle · Gemüsetopf mit Deckel  
Low stock pot with lid · Panela baixa com tampa

Ref	€	Ø (cm)	h(cm)	e (mm)	L	U.Venta
50119	64,90	20	15,0	0,8	4,70	1
50123	86,50	24	20,0	0,8	9,00	1
50127	112,90	28	22,0	0,8	13,50	1
50131	164,50	32	26,0	1,0	20,80	1
50135	191,20	36	29,0	1,0	29,50	1
50139	241,00	40	32,0	1,2	40,00	1



### Olla baja sin tapa

Marmite basse s/couvercle · Gemüsetopf ohne Deckel  
Low stock pot without lid · Panela baixa sem tampa

Ref	€	Ø (cm)	U.Venta
50119S	51,00	20	1
50123S	71,30	24	1
50127S	95,50	28	1
50131S	141,50	32	1
50135S	163,40	36	1
50139S	209,80	40	1



### Cazo

Casserole · Stielkasserolle, flach  
Saucepan · Caçarola direite

Ref	€	Ø (cm)	h(cm)	e (mm)	L	U.Venta
50212	28,10	12	7,0	0,7	0,75	1
50214	30,30	14	7,5	0,7	1,10	1
50216	33,30	16	8,0	0,8	1,60	1
50218	36,00	18	9,0	0,8	2,20	1
50220	39,80	20	9,0	0,8	2,80	1
50224	49,00	24	9,5	0,8	4,25	1
50228	68,70	28	11,0	0,8	6,75	1



### Cazo alto

Casserole haute · Stielkasserolle, hoch  
Deep saucepan · Caçarola alta direite

Ref	€	Ø (cm)	h(cm)	e (mm)	L	U.Venta
50217	35,50	16	11,0	0,8	2,10	1
50219	41,20	18	12,0	0,8	3,00	1
50221	46,40	20	13,0	0,8	4,00	1
50225	56,60	24	14,0	0,8	6,30	1
50229	77,00	28	17,5	0,8	10,20	1



### Cazo Francés

Casserole Française · Stielkasserolle, französisch  
French saucepan · Francês caçarola direita

Ref	€	Ø (cm)	h(cm)	e (mm)	L	U.Venta
50225N	54,30	24	12,0	0,8	5,50	1
50229N	70,40	28	14,0	0,8	8,50	1



### Cazo Cónico

Sautase conique · Sauteuse, Konisch  
Conical saute pan · Caçarola cónica

Ref	€	Ø (cm)	h(cm)	e (mm)	L	U.Venta
51216	40,40	16	6,0	1,0	1,00	1
51218	42,50	18	6,0	1,0	1,20	1
51220	44,40	20	6,5	1,0	1,60	1
51222	48,50	22	7,0	1,0	2,10	1
51224	53,10	24	7,5	1,0	2,70	1



### Baño maría con fondo

Bahut avec fond · Bain Marie Topf  
Double boiler with bottom · Banho-Maria com fundo

Ref	€	Ø (cm)	h(cm)	e (mm)	L	U.Venta
50717	40,90	16	16,0	0,8	3,20	1
50721	53,10	20	20,0	0,8	6,20	1



### Rustidera

Couvercle · Deckel  
Lid · Tampa

Ref	€	cm	h(cm)	e (mm)	U.Venta
50540	118,40	40x30	8,0	1,0	1
50550	156,80	50x40	8,0	1,0	1
50560	197,50	60x45	8,0	1,0	1
50570	225,60	70x45	9,5	1,0	1



### Tapa

Plat à roir · Bratpfanne  
Roaster · Assadeira

Ref	€	Ø (cm)	U.Venta
50916	10,60	16	1
50918	11,80	18	1
50920	13,90	20	1
50924	15,20	24	1
50928	17,40	28	1
50932	23,00	32	1
50936	27,80	36	1
50940	31,20	40	1
50945	37,30	45	1
50950	45,80	50	1
50960	59,80	60	1

Máxima garantía en resistencia y durabilidad  
Maximum guarantee in resistance and durability



## Eco Chef

INOX 18/10  
Sandwich Induction Vitro Electric Gas Oven Dishwasher

- **Toda la pieza (cuerpo, asas y mangos) fabricada en acero inoxidable.**
  - **Fondo termodifusor (inox 18/10 - aluminio - inox). Espesor 0,6 - 1 mm.**
  - **Tapas diseñadas para el ahorro energético.**
  - **Acabado interior mate y exterior brillo-mate.**
  - **Máxima garantía en cuanto a resistencia, durabilidad e higiene.**
- Toute la pièce (corps, poignées et manches) est fabriquée en acier inoxydable.
  - Fond thermo-diffuseur (Inox 18/10 - Aluminium - Inox). Épaisseur 0,6 - 1 mm.
  - Couvercles conçus pour une économie d'énergie.
  - Finition mate intérieur et brillant-mate extérieur.
  - Garantie maximale en termes de résistance, de durabilité et d'hygiène.
- The whole product (body, handles and grips) is made in stainless steel.
  - Heat diffuser bottom (18/10 stainless steel - Aluminium - Stainless). Thickness 0.6 - 1 mm.
  - Covers designed for saving energy.
  - Interior matte finish and exterior brightness-matte finish.
  - Maximum guarantee in terms of resistance, durability and hygiene.



### Cacerola sin tapa

Faitout sans couvercle · Bratentopf ohne Deckel  
Casserole without lid · Caçarola sem tampa

Ref	€	Ø (cm)	h(cm)	e (mm)	L	U.Venta
57016	29,30	16	8,0	0,6	1,60	1
57020	36,00	20	9,0	0,6	2,80	1
57024	39,30	24	9,5	0,7	4,25	1
57028	62,50	28	11,0	0,7	6,75	1
57032	74,50	32	12,5	0,7	10,00	1
57036	114,80	36	14,5	0,7	14,20	1
57040	130,80	40	15,5	0,9	19,40	1



### Cacerola alta sin tapa

Braisiere sans couvercle · Fleischtopf ohne Deckel  
Deep casserole without lid · Caçarola alta sem tampa

Ref	€	Ø (cm)	h(cm)	e (mm)	L	U.Venta
57017	31,20	16	11,0	0,6	2,20	1
57021	37,90	20	13,0	0,6	4,00	1
57025	46,40	24	15,0	0,7	7,00	1
57029	68,30	28	17,5	0,7	10,00	1
57033	82,60	32	18,0	0,7	14,40	1
57037	125,90	36	21,5	0,9	21,80	1
57041	154,50	40	24,5	0,9	30,70	1



### Olla recta sin tapa

Marmite traiteur sans couvercle · Suppentopf ohne Deckel  
Stock pot without lid · Panela sem tampa

Ref	€	Ø (cm)	h (cm)	e (mm)	L	U.Venta
57116	35,60	16	16,0	0,7	3,20	1
57120	41,70	20	20,0	0,7	6,20	1
57124	58,70	24	24,0	0,7	10,50	1
57128	86,50	28	25,5	0,9	16,50	1
57132	129,60	32	32,0	0,9	25,70	1
57136	162,80	36	36,0	0,9	36,60	1
57140	200,40	40	40,0	1,0	50,00	1



### Paellera sin tapa

Plat rond sans couvercle · Pfanne ohne Deckel  
Round without lid · Paelheira sem tampa

Ref	€	Ø (cm)	h (cm)	e (mm)	L	U.Venta
57624	38,70	24	6,5	0,7	3,00	1
57628	53,60	28	6,5	0,7	4,00	1
57632	68,50	32	7,0	0,7	5,00	1
57636	94,30	36	7,0	0,9	7,10	1
57640	108,70	40	8,0	0,9	10,00	1



### Tapa

Couvercle · Deckel  
Lid · Tampa

Ref	€	Ø (cm)	U.Venta
57916	11,00	16	1
57920	13,90	20	1
57924	15,10	24	1
57928	17,40	28	1
57932	22,50	32	1
57936	27,70	36	1
57940	31,30	40	1



### Cazo

Casserole · Stielkasserolle, flach  
Saucepan · Caçarola direite

Ref	€	Ø (cm)	h (cm)	e (mm)	L	U.Venta
57212	22,20	12	7,0	0,6	0,75	1
57214	23,70	14	7,5	0,6	1,10	1
57216	25,20	16	8,0	0,6	1,60	1
57218	27,70	18	8,5	0,6	2,00	1
57220	31,00	20	9,0	0,6	2,80	1
57224	40,00	24	9,5	0,7	4,25	1



### Cazo alto

Casserole haute · Stielkasserolle, hoch  
Deep saucepan · Caçarola alta direite

Ref	€	Ø (cm)	h (cm)	e (mm)	L	U.Venta
57217	27,70	16	11,0	0,6	2,10	1
57219	32,30	18	12,0	0,6	3,00	1
57221	36,60	20	13,0	0,6	4,00	1
57225	50,30	24	15,0	0,7	6,50	1



### Baño maría con fondo

Bahut avec fond · Bain marie Topf  
Double boiler with bottom · Banho-Maria com fundo

Ref	€	Ø (cm)	h (cm)	e (mm)	L	U.Venta
57717	32,60	16	16,0	0,7	3,20	1
57721	43,70	20	20,0	0,7	6,20	1



### Sautex

Sauteuse · Sauteuse  
Sauteuse · Frigideira

Ref	€	Ø (cm)	h (cm)	e (mm)	L	U.Venta
57625	36,60	24	6,5	0,7	2,70	1
57629	55,40	28	6,5	0,7	4,00	1

# Gastro Garinox



- **Batería Gastro de Garinox.**
- **Toda la pieza (cuerpo, asas y mangos) fabricada en acero inoxidable.**
- **Espesor de 0,6mm.**
- **Fondo termodifusor (inox 18/10 - aluminio - inox).**
- **Tapas diseñadas para el ahorro energético.**
- **Apta para todos los tipos de cocina (incluida inducción y horno).**
- **Máxima garantía en cuanto a resistencia, durabilidad e higiene.**

- Batterie de cuisine Garinox Gastro.
- L'ensemble de la pièce (corps, poignées et manches) est en acier inoxydable.
- Epaisseur de 0,6 mm.
- Fond termodiffuseur (acier inoxydable 18/10 - aluminium - acier inoxydable).
- Couverts conçus pour économiser l'énergie.
- Convient à tous les types de cuisinières (y compris induction et four).
- Garantie maximale en termes de résistance, de durabilité et d'hygiène.

- Garinox Gastro cookware.
- The whole piece (body, handles and grips) is made of stainless steel.
- Thickness of 0,6mm.
- Thermo-diffuser bottom (18/10 stainless steel - aluminium - stainless steel).
- Lids designed for energy saving.
- Suitable for all types of cookers (including induction and oven).
- Maximum guarantee in terms of resistance, durability and hygiene.



### Cacerola sin tapa

Faitout sans couvercle · Bratentopf ohne Deckel  
Casserole without lid · Caçarola sem tampa

Ref	€	Ø (cm)	h (cm)	L	U.Venta
16020	29,40	20	9,0	2,75	1
16024	32,40	24	9,5	4,20	1
16028	42,90	28	11,0	6,70	1
16032	54,30	32	12,5	10,00	1
16036	82,80	36	14,5	14,70	1
16040	104,40	40	15,5	19,50	1



### Olla recta sin tapa

Marmite traiteur s/couvercle · Suppentopf ohne Deckel  
Stock Pot without lid · Panela sem tampa

Ref	€	Ø (cm)	h (cm)	L	U.Venta
16120	38,50	20	20,0	6,2	1
16124	48,90	24	24,0	10,8	1
16128	60,20	28	25,5	15,5	1
16132	93,10	32	32,0	25,5	1
16136	117,70	36	36,0	36,5	1
16140	151,00	40	40,0	50,0	1



### Paellera sin tapa

Plat rond s/couvercle · Pfanne ohne Deckel  
Round dish without lid · Paelheira sem tampa

Ref	€	Ø (cm)	h (cm)	L	U.Venta
16624	32,20	24	6,5	2,8	1
16628	40,00	28	6,5	4,0	1
16632	49,50	32	7,0	5,5	1
16636	66,80	36	7,0	7,0	1
16640	92,10	40	8,0	10,0	1



### Cacerola alta sin tapa

Braisiere sans couvercle · Fleischtopf ohne Deckel  
Deep casserole without lid · Caçarola alta sem tampa

Ref	€	Ø (cm)	h (cm)	L	U.Venta
16021	30,70	20	13,0	4,00	1
16025	38,60	24	15,0	6,70	1
16029	48,00	28	17,5	10,70	1
16033	63,40	32	18,0	14,50	1
16037	94,20	36	21,5	21,80	1
16041	118,30	40	24,5	30,70	1



### Cazo

Casserole · Stielkasserolle, flach  
Saucepan · Caçarola direite

Ref	€	Ø (cm)	h (cm)	L	U.Venta
16212	15,90	12	7,0	0,75	1
16214	17,10	14	7,5	1,00	1
16216	18,60	16	8,0	1,50	1
16218	21,20	18	8,0	2,00	1
16220	23,80	20	9,0	2,75	1
16224	29,80	24	9,5	4,20	1



### Tapa

Couvercle · Deckel  
Lid · Tampa

Ref	€	Ø (cm)	U.Venta
16920	8,30	20	1
16924	9,40	24	1
16928	11,30	28	1
16932	15,00	32	1
16936	17,50	36	1
16940	20,20	40	1

**Aluminio puro (99,5%)**  
Made in pure aluminium (99,5%)



## Chef Aluminio

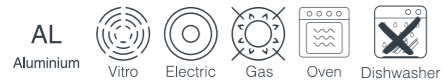

- **Cuerpo fabricado en aluminio puro (99,5%).**
- **Asas y mangos atérmicos en tubo de acero inoxidable 18/10.**
- **Tapa diseñada para el ahorro energético.**
- **Apta para todos los tipos de cocina (excepto inducción).**
- **Acabado mate interior y exterior mate lijado.**
- **Máxima garantía en cuanto a resistencia, durabilidad e higiene.**

- Corps en aluminium pur (99,5%).
- Mangoes asas et atrmon dans le tube d'acier inoxydable 18/10.
- Couverture conçue pour les économies d'énergie.
- Convient à tous les types de cuisine (sauf induction).
- Finition mate mate et extérieure.
- Garantie maximale en termes de résistance, de durabilité et d'hygiène.

- Body made of pure aluminum (99.5%).
- Asas and atrmon mangoes in stainless steel tube 18/10.
- Cover designed for energy savings.
- Suitable for all types of kitchen (except induction).
- Matte inner and exterior matte finish.
- Maximum guarantee in terms of resistance, durability and hygiene.



### Cacerola con tapa

Braisiere a/couvercle · Bratentopf mit Deckel  
Casserole with lid · Caçarola com tampa

Ref	€	Ø (cm)	h(cm)	e (mm)	L	U.Venta
20020	50,00	20	8,0	2,5	2,50	1
20024	55,80	24	9,5	2,5	4,30	1
20028	67,20	28	11,0	2,5	6,75	1
20030	72,20	30	11,5	2,5	8,15	1
20032	77,20	32	12,0	2,5	9,65	1
20034	83,90	34	13,0	3,0	11,80	1
20036	89,10	36	14,0	3,0	14,25	1
20038	99,90	38	15,0	3,0	17,00	1
20040	105,30	40	16,0	3,0	21,10	1
20045	125,70	45	18,0	3,5	28,00	1
20050	150,40	50	21,0	3,5	41,00	1
20060	214,20	60	25,0	4,5	70,00	1

### Cacerola alta con tapa

Braisiere avec couvercle · Fleischtopf mit Deckel  
Deep casserole with lid · Caçarola alta com tampa

Ref	€	Ø (cm)	h(cm)	e (mm)	L	U.Venta
20021	54,40	20	13,0	2,5	4,10	1
20025	62,50	24	15,0	2,5	6,80	1
20029	72,10	28	17,0	2,5	10,45	1
20031	78,70	30	18,0	2,5	12,70	1
20033	91,20	32	19,0	3,0	15,25	1
20035	98,30	34	21,0	3,0	18,05	1
20037	100,70	36	22,0	3,0	22,40	1
20039	109,20	38	23,0	3,0	26,10	1
20041	125,70	40	25,0	3,5	31,40	1
20046	143,70	45	28,0	4,5	45,00	1
20051	190,70	50	31,0	4,5	60,00	1
20061	252,90	60	37,0	4,5	104,00	1



### Olla recta con tapa

Marmite traiteur a/couvercle · Suppentopf mit Deckel  
Stock pot with lid · Panela com tampa

Ref	€	Ø (cm)	h(cm)	e (mm)	L	U.Venta
20120	61,90	20	20,0	2,5	6,30	1
20124	72,20	24	24,0	2,5	10,85	1
20128	90,80	28	28,0	3,0	17,25	1
20130	99,40	30	30,0	3,0	21,20	1
20132	109,40	32	32,0	3,0	25,75	1
20134	121,00	34	34,0	3,5	30,90	1
20136	130,20	36	36,0	3,5	36,65	1
20138	139,20	38	38,0	3,5	43,10	1
20140	156,10	40	40,0	4,0	50,30	1
20145	192,50	45	45,0	4,5	72,00	1
20150	216,90	50	50,0	4,5	100,00	1
20160	316,30	60	55,0	5,0	155,50	1



### Paellera

Plat rond · Pfanne  
Round · Paelheira

Ref	€	Ø (cm)	h(cm)	e (mm)	L	U.Venta
20628	42,90	28	7,0	2,5	4,30	1
20630	45,60	30	6,5	2,5	4,75	1
20632	48,80	32	7,0	2,5	5,50	1
20634	51,60	34	7,0	2,5	6,35	1
20636	54,50	36	7,5	2,5	7,45	1
20638	55,40	38	7,5	3,0	8,60	1
20640	65,10	40	8,0	3,0	10,05	1
20645	71,20	45	8,0	3,0	12,50	1
20650	83,00	50	8,0	3,0	15,50	1
20660	118,70	60	10,0	3,5	28,00	1



### Cazo

Casserole · Stielkasserolle, flach  
Saucepan · Caçarola direite

Ref	€	Ø (cm)	h(cm)	e (mm)	L	U.Venta
20216	27,90	16	7,0	2,5	1,40	1
20220	33,40	20	8,0	2,5	2,50	1
20224	38,00	24	9,5	2,5	4,30	1
20228	45,10	28	11,0	2,5	6,80	1



### Cazo alto

Casserole haute · Stielkasserolle, hoch  
Deep saucepan · Caçarola alta direite

Ref	€	Ø (cm)	h(cm)	e (mm)	L	U.Venta
20217	33,00	16	11,0	2,5	2,20	1
20221	38,30	20	13,0	2,5	4,10	1
20225	44,60	24	15,0	2,5	6,80	1
20229	51,60	28	17,0	2,5	10,50	1



### Cazo Bombado

Casserole bombée · Kasserolle, Bauchig  
Rounded saucepan · Caçarola bojuda

Ref	€	Ø (cm)	h(cm)	e (mm)	L	U.Venta
21216	28,10	16	8,0	2,5	1,50	1
21220	33,70	20	10,0	2,5	2,50	1
21224	39,90	24	12,0	2,5	4,00	1
21228	47,10	28	14,0	2,5	6,50	1



### Pote cilíndrico

Pot-cilindrique · Milchtopf  
Cylindrical pot · Caneca cilíndrica

Ref	€	Ø (cm)	h(cm)	e (mm)	L	U.Venta
20716	35,40	16	16,0	2,5	3,20	1
20720	41,60	20	20,0	2,5	6,30	1





### Rustidera con asas fijas

Plat à rotir anse fixe · Bratpfanne, m. festehenden Griffen  
Roaster fix handle · Assadeira com asa fixa

Ref	€	cm	h(cm)	e (mm)	L	U.Venta
20540F	55,40	40x30	6,2	2,5	7,45	1
20545F	59,40	45x32	6,2	2,5	10,40	1
20550F	74,60	50x35	7,0	3,0	12,60	1
20555F	81,00	55x37	7,7	3,0	16,30	1
20560F	87,60	60x40	7,7	3,0	18,95	1
20565F	97,40	65x43	7,9	3,0	24,30	1
20570F	103,00	70x45	9,0	3,0	28,65	1



### Rustidera con asas abatibles

Plat à rotir anse tombante · Bratpfanne mit Fallgriffen  
Roaster moving handle · Assadeira com asa abatível

Ref	€	cm	h(cm)	e (mm)	L	U.Venta
20540A	55,40	40x30	6,2	2,5	7,45	1
20545A	59,40	45x32	6,2	2,5	10,40	1
20550A	74,60	50x35	7,0	3,0	12,60	1
20555A	81,00	55x37	7,7	3,0	16,30	1
20560A	87,00	60x40	7,7	3,0	18,95	1
20565A	97,40	65x43	7,9	3,0	24,30	1
20570A	103,00	70x45	9,0	3,0	28,65	1



### Hervidor de pescado

Poissonnière avec grille · Fischkessel mit Einsatz  
Fish kettle with grill and lid · Peixeira

Ref	€	cm	h(cm)	e (mm)	L	U.Venta
20470	209,40	70x22	20,80	2,5	14,0	1



### Bandeja horno

Plaque à four · Backblech  
Oven tray · Bandeja forno

Ref	€	cm	h(cm)	e (mm)	U.Venta
20551	41,60	50x35	2,0	2,5	1
20561	50,70	60x40	2,0	2,5	1



### Tapa

Couvercle · Deckel  
Lid · Tampa

Ref	€	Ø (cm)	U.Venta
20920	14,90	20	1
20924	15,90	24	1
20928	19,30	28	1
20930	20,10	30	1
20932	22,30	32	1
20934	22,80	34	1
20936	24,40	36	1
20938	25,50	38	1
20940	28,40	40	1
20945	30,90	45	1
20950	36,80	50	1
20960	43,40	60	1

# Baterias domésticas

## Household cookware



## Combi Collection



- Fabricadas en acero inoxidable 18/10 de la mejor calidad.
- Máxima garantía en cuanto a resistencia, durabilidad e higiene.
- Acabado interior y exterior lijado satinado.
- Antiadherente QuanTanium® reforzado con partículas de titanio; libre de materiales tóxicos y pesados, ecológico y libre de PFOA
- Fondo termodifusor sandwich (inox 18/10 - aluminio - inoxidable).
- Distribución rápida y uniforme del calor.
- Aptas para todos los fuegos (incluido inducción y horno).
- Asas/mangos extraíbles fabricadas en baquelita termorresistente. Disponibles en tres colores.
- Ahorra espacio de almacenaje.

- Fabriquées en acier inoxydable 18/10 de la meilleure qualité.
- Garantie maximale en termes de résistance, de durabilité et d'hygiène.
- Marquage des contenances à l'intérieur (litres).
- Finition intérieure et extérieure en polissage satiné.
- Revêtement antiadhésif QuanTanium® renforcé par des particules de titane; exempt de matériaux toxiques et lourds, respectueux de l'environnement et sans PFOA.
- Fond thermodiffuseur sandwich (inox 18/10 - aluminium - inoxydable).
- Distribution rapide et uniforme de la chaleur.
- Aptes pour tous les types de feux (y compris l'induction et le four).
- Poignées / manches amovibles fabriqué en bakélite thermo-isolante. Disponible en trois couleurs.
- Économie d'espace de stockage.

- Manufactured with the highest quality 18/10 stainless steel.
- Maximum guarantee in terms of resistance, durability and hygiene.
- Capacity markings on the inside (litres).
- Glossy sanded interior and exterior finish
- QuanTanium® non-stick reinforced with titanium particles; free from toxic and heavy materials, environmentally friendly and PFOA-free.
- Heat-diffusing sandwiched base (18/10 stainless steel - aluminium - st. Steel)
- Quick and even heat distribution.
- Suitable for all types of cookers (including induction hobs and ovens).
- Handles / grips made in heat resistant bakelite. Available in three colours.
- Saves storage space.



**Apilables:**  
ahorra espacio de almacenamiento  
Empilables:  
elle permet de gagner de l'espace de rangement.  
Stackable: save storage space



**Sistema Click&Lock:**  
Mango y asas desmontables  
Système Click&Lock:  
Poignées et manches démontable  
Click&Lock system:  
Detachable handles and grips



**Tapa de cristal resistente a los golpes con válvula y borde de acero inoxidable 18/10**  
Couvercle en verre avec soupape résistante aux chocs et bord en acier inoxydable 18/10  
Glass cover with pressure valve resistant to bumps and 18/10 stainless steel rim



### Cuerpo para cacerola/cazo

Corps pour faitout/casserole · Körper für Bratentopf/Stielkasserolle  
Body for casserole/saucepan · Corpo para caçarola/caçarola direita

Ref	€	Ø (cm)	h(cm)	e (mm)	L	U.Venta
56614	22,10	14	7,0	0,8	1,00	1
56616	25,40	16	8,0	0,8	1,50	1
56618	29,30	18	9,0	0,8	2,00	1
56620	33,30	20	10,0	0,8	3,00	1
56624	44,90	24	12,0	0,8	5,50	1



### Cuerpo para tartera/sartén

Corps pour plat rond/poêle · Körper für Pfanne/Pfanne  
Body for round dish/frying pan · Corpo para tarteira/sertã

Ref	€	Ø (cm)	h(cm)	e (mm)	L	U.Venta
56720	24,30	20	4,0	0,8	1,00	1
56724	30,20	24	4,5	0,8	2,00	1
56728	41,00	28	5,0	0,8	3,00	1
56732	48,90	32	5,5	0,8	4,00	1



### Set 3 cazos Combi

Ensemble 3 casseroles + poignée · Set 3 Kochtöpfe + Griff  
Set 3 saucepans + handle · Conjunto de 3 panelas + pega

Ref	€	Ø (cm)	h(cm)	e (mm)	L	U.Venta
56610	96,20	16	8,0	0,8	1,5	1

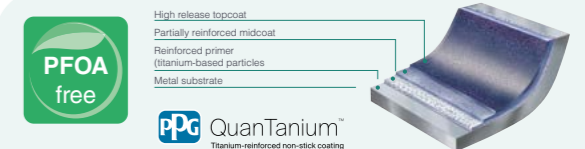

**Antiadherente QuanTanium® reforzado con partículas de titanio; libre de materiales tóxicos y pesados, ecológico y libre de PFOA**  
QuanTanium® non-stick reinforced with titanium particles; free from toxic and heavy materials, environmentally friendly and PFOA-free.



### Cuerpo para tartera/sartén antiadherente

Corps pour plat rond/poêle · Körper für Pfanne/Pfanne  
Body for round dish/frying pan · Corpo para tarteira/sertã

Ref	€	Ø (cm)	h(cm)	e (mm)	L	U.Venta
56820	31,70	20	4,0	0,8	1,00	1
56824	38,40	24	4,5	0,8	2,00	1
56828	51,10	28	5,0	0,8	3,00	1
56832	59,30	32	5,5	0,8	4,00	1



### Asa

Poignée · Griff  
Handle · Asa

Ref	€	Color	U.Venta
56600	13,40	Negro · Black	1
56604	13,70	Azul · Blue	1
56602	13,70	Rojo · Red	1



### Mango

Poignée · Griff  
Handle · Cabo

Ref	€	Color	U.Venta
56601	14,60	Negro · Black	1
56605	14,80	Azul · Blue	1
56603	14,80	Rojo · Red	1



### Tapa

Couvercle · Deckel  
Lid · Tampa

Ref	€	Ø (cm)	U.Venta
56914	16,90	14	1
56916	17,50	16	1
56918	18,30	18	1
56920	19,20	20	1
56924	20,50	24	1
56928	21,20	28	1
56932	22,10	32	1



## Origin Collection



- Fabricadas en acero inoxidable 18/10 de la mejor calidad.
- Asas fabricadas en acero inoxidable con recubrimiento PVD (proceso de chapado iónico con titanio, metal de gran dureza).
- Tapa fabricada en vidrio templado con válvula de salida de vapor y aro protector de acero inoxidable con recubrimiento PVD.
- Máxima garantía en cuanto a resistencia, durabilidad e higiene.
- Marcaje de capacidades en el interior (litros).
- Fondo termodifusor sandwich (inox 18/10 - aluminio - inoxidable).
- Distribución rápida y uniforme del calor.
- Apta para todos los fuegos (incluido inducción y horno) . Apta para el lavavajillas.

- Fabriquées en acier inoxydable 18/10 de la meilleure qualité.
- Poignées en acier inoxydable avec revêtement PVD (procédé de placage ionique avec du titane, métal de haute dureté).Couvercle en verre trempé avec soupape d'évacuation de la vapeur et anneau de protection en acier inoxydable revêtu de PVD
- Garantie maximale en termes de résistance, de durabilité et d'hygiène.
- Marquage des contenances à l'intérieur (litres).
- Fond termodiffuseur sandwich (inox 18/10 - aluminium - inoxydable).
- Distribution rapide et uniforme de la chaleur.
- Apte pour tous les types de feux (y compris l'induction et le four). Aptes pour le lave-vaisselle.

- Maximum guarantee in resistance, durability and hygiene.
- Handles made of stainless steel with PVD coating (ionic plating process with titanium, high hardness metal).
- Lid made of tempered glass with steam outlet valve and protective ring made of PVD-coated stainless steel
- Maximum guarantee in terms of resistance, durability and hygiene.
- Capacity markings on the inside (litres).
- Heat-diffusing sandwiched base (18/10 stainless steel - aluminium - st. Steel).
- Quick and even heat distribution.
- Suitable for all types of cookers (including induction hobs and ovens). Dishwasher safe.



**Recubrimiento PVD**  
PVD coating  
**Proceso de chapado iónico con titanio, metal de gran dureza**  
Ionic plating process with titanium, high hardness metal



**Tapa fabricada en vidrio templado**  
Lid made of tempered glass  
**Aro protector de acero inoxidable con recubrimiento PVD**  
Protective ring made of PVD-coated stainless steel

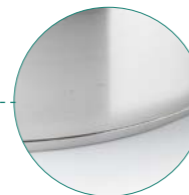

**Distribución rápida y uniforme del calor**  
Quick and even heat distribution  
**Fondo termodifusor sandwich (inox 18/10 - aluminio - inoxidable)**  
Heat-diffusing sandwiched base (18/10 stainless steel - aluminium - st. Steel).



### Cacerola con tapa

Faitout avec couvercle · Bratentopf mit Deckel  
Casserole with lid · Caçarola com tampa

Ref	€	Ø (cm)	h(cm)	e (mm)	L	U.Venta
47020	50,20	20	10	0,8	3,00	1
47024	58,80	24	12	0,8	5,20	1
47028	68,70	28	14	0,8	8,30	1



### Cacerola baja con tapa

Faitout bas avec couvercle · Bratentopf mit Deckel  
asserole with lid · Caçarola baixa com tampa

Ref	€	Ø (cm)	h(cm)	e (mm)	L	U.Venta
47128	63,10	28	8	0,8	4,70	1



### Cazo

Casserole · Stielkasserolle, flach  
Saucepan · Caçarola direite

Ref	€	Ø (cm)	h(cm)	e (mm)	L	U.Venta
47214	26,00	14	7	0,8	1,00	1
47216	28,50	16	8	0,8	1,50	1
47218	31,20	18	9	0,8	2,10	1
47220	35,20	20	10	0,8	3,00	1

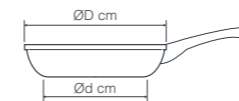

### Tapa

Couvercle · Deckel  
Lid · Tampa

Ref	€	Ø (cm)	U.Venta
47620	15,70	20	1
47624	17,00	24	1
47628	18,90	28	1

**PFOA free**

High release topcoat  
Partially reinforced midcoat  
Reinforced primer  
(titanium-based particles)  
Metal substrate

**PPG Quantanium™**  
Titanium-reinforced non-stick coating

**Antiadherente Quantanium® reforzado con partículas de titanio; libre de materiales tóxicos y pesados, ecológico y libre de PFOA**  
QuanTanium® non-stick reinforced with titanium particles; free from toxic and heavy materials, environmentally friendly and PFOA-free.



### Sartén

Poêle · Pfanne  
Frying pan · Sertã

Ref	€	Ø (cm)	Ød (cm)	h(cm)	e (mm)	U.Venta
47318	25,00	18	12,5	4,00	0,6	1
47320	27,80	20	12,5	4,20	0,6	1
47322	30,00	22	16,8	4,40	0,6	1
47324	31,90	24	18,5	4,60	0,6	1
47328	35,70	28	21,2	4,80	0,6	1
47330	38,80	30	23,0	5,00	0,6	1



### Sartén antiadherente

Poêle antiadherent · Pfanne, Antihaft  
Frying-pan, non-stick · Sertã anti-aderente

Ref	€	Ø (cm)	Ød (cm)	h(cm)	e (mm)	U.Venta
47418	29,60	18	12,5	4,00	0,6	1
47420	32,80	20	12,5	4,20	0,6	1
47422	35,20	22	16,8	4,40	0,6	1
47424	37,50	24	18,5	4,60	0,6	1
47428	42,50	28	21,2	4,80	0,6	1
47430	46,30	30	23,0	5,00	0,6	1



# Foodie Collection

INOX 18/10 Sandwich Induction Vitro Electric Gas Oven Dishwasher

- Fabricada en acero inoxidable 18/10 de la mejor calidad.
- Asas y mangos ergonómicos de acero inoxidable fundido.
- Máxima garantía en cuanto a resistencia, durabilidad e higiene.
- Acabado interior y exterior lijado satinado.
- Marcaje de capacidades en el interior (litros).
- Fondo termodifusor sándwich (inox 18/10 - aluminio - inoxidable).
- Distribución rápida y uniforme del calor.
- Apta para todos los fuegos (incluido inducción y horno).

- Fabriqué en acier inoxydable 18/10 de la meilleure qualité.
- Poignées et purée de maîtrise en acier inoxydable en fusion.
- Garantie maximale en termes de résistance, de durabilité et d'hygiène.
- Satin de finition interne et extérieur.
- Marquage de capacité à l'intérieur (litres).
- Contexte de termodifusor sandwich (en acier inoxydable 18/10 - aluminium - en acier inoxydable).
- Distribution rapide et uniforme de la chaleur.
- Convient à tous les incendies (y compris l'induction et le four).

- Made of stainless steel 18/10 of the best quality.
- Asas and ergonomic mashed masters of molten stainless steel.
- Maximum guarantee in terms of resistance, durability and hygiene.
- Internal and exterior finish satin.
- Capacity marking inside (liters).
- Sandwich thermodifusor background (stainless 18/10 - Aluminum - stainless).
- Quick and uniform distribution of heat.
- Suitable for all fires (including induction and oven).



## Cacerola con tapa

Faitout avec couvercle · Bratentopf mit Deckel  
Casserole with lid · Caçarola com tampa

Ref	€	Ø (cm)	h(cm)	e (mm)	L	U.Venta
45016	46,90	16	7,5	0,8	1,50	1
45018	51,00	18	8,5	0,8	2,00	1
45020	55,70	20	9,5	0,8	3,00	1
45022	63,30	22	10,5	0,8	4,00	1
45024	69,80	24	11,5	0,8	5,00	1
45026	77,20	26	12,5	0,8	6,50	1
45028	83,40	28	12,5	0,8	7,50	1



## Cazo

Casserole · Stielkasserolle, flach  
Saucepan · Caçarola direite

Ref	€	Ø (cm)	h(cm)	e (mm)	L	U.Venta
45214	33,70	14	7,5	0,8	1,00	1
45216	36,30	16	7,5	0,8	1,50	1
45218	40,50	18	8,5	0,8	2,00	1
45220	45,90	20	9,5	0,8	3,00	1

## Olla con tapa

Marmite avec couvercle · Fleischtopf mit Deckel  
Stock pot with lid · Panela com tampa

Ref	€	Ø (cm)	h(cm)	e (mm)	L	U.Venta
45116	51,70	16	13,0	0,8	2,50	1
45118	55,30	18	14,0	0,8	3,50	1
45120	62,50	20	15,5	0,8	4,80	1
45122	68,00	22	15,5	0,8	5,50	1
45124	75,70	24	16,0	0,8	7,00	1
45126	82,80	26	16,0	0,8	8,00	1
45128	94,00	28	17,0	0,8	10,00	1



## Tartera con tapa

Plat rond avec couvercle · Pfanne mit Deckel  
Round dish with lid · Tarteira com tampa

Ref	€	Ø (cm)	h(cm)	e (mm)	L	U.Venta
45624	64,20	24	6,5	0,8	2,80	1
45626	70,50	26	6,5	0,8	3,00	1
45628	76,20	28	6,5	0,8	4,00	1

## Tapa

Couvercle · Deckel  
Lid · Tampa



Ref	€	Ø (cm)	U.Venta
45916	12,60	16	1
45918	13,20	18	1
45920	14,30	20	1
45922	15,40	22	1
45924	17,00	24	1
45926	18,10	26	1
45928	20,00	28	1



## Sartén

Poêle · Pfanne  
Frying pan · Sertã

Ref	€	Ø (cm)	Ød (cm)	h(cm)	e (mm)	U.Venta
45420	28,10	20	13,5	5,5	0,6	1
45422	29,90	22	14,5	5,5	0,6	1
45424	33,50	24	17,5	6,0	0,6	1
45426	35,60	26	19,0	6,0	0,6	1
45428	39,40	28	19,5	6,5	0,6	1
45430	40,60	30	22,0	6,5	0,6	1



High release topcoat  
Partially reinforced midcoat  
Reinforced primer  
(titanium-based particles)  
Metal substrate

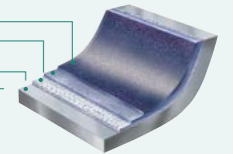

QuanTanium®  
Titanium-reinforced non-stick coating

Antiadherente QuanTanium® reforzado con partículas de titanio; libre de materiales tóxicos y pesados, ecológico y libre de PFOA  
QuanTanium® non-stick reinforced with titanium particles; free from toxic and heavy materials, environmentally friendly and PFOA-free.



## Sartén antiadherente

Poêle antiadherent · Pfanne, Antihafht  
Frying-pan, non-stick · Sertã anti-aderente

Ref	€	Ø (cm)	Ød (cm)	h(cm)	e (mm)	U.Venta
45320	33,10	20	13,5	5,5	0,6	1
45322	34,30	22	14,5	5,5	0,6	1
45324	40,50	24	17,5	6,0	0,6	1
45326	41,50	26	19,0	6,0	0,6	1
45328	48,50	28	19,5	6,5	0,6	1
45330	49,60	30	22,0	6,5	0,6	1



## Wok

Wok · Wok  
Wok · Wok

Ref	€	Ø (cm)	Ød (cm)	h(cm)	U.Venta
45828	40,00	28	15,6	8,0	1



## Wok antiadherente

Wok, Antiadherent · Wok, Antihafht  
Wok, non-stick · Wok anti-aderente

Ref	€	Ø (cm)	Ød (cm)	h(cm)	U.Venta
45728	48,20	28	15,6	8,0	1



## Crepera

Crepière · Crêpes-Pfanne  
Crepiere · Crepeira

Ref	€	Ø (cm)	Ød (cm)	h(cm)	U.Venta
45829	39,50	28	24	1,8	1



## Crepera antiadherente

Crepière, antiadherent · Crêpes-Pfanne, Antihafht  
Crepiere, Non-stick · Crepeira anti-aderente

Ref	€	Ø (cm)	Ød (cm)	h(cm)	U.Venta
45729	42,30	28	24	1,8	1



## Profesional Collection



- **Toda la pieza (cuerpo, asas y mangos) fabricada en acero inoxidable 18/10.**
- **Favorece una distribución rápida y homogénea del calor.**
- **Acabado pulido brillante exterior y lijado mate interior.**
- **Máxima garantía en cuanto a resistencia, durabilidad e higiene.**
- **Apta para todo tipo de cocinas (incluido inducción y horno).**
- **Fondo termodifusor sándwich (inox 18/10 - aluminio - inox).**

- La pièce entière (corps, poignées et mangues) en acier inoxydable 18/10.
- Il favorise une distribution rapide et homogène de la chaleur.
- Finition extérieure et polie et ponçage de Matt intérieur.
- Garantie maximale en termes de résistance, de durabilité et d'hygiène.
- Convient à tous les types de cuisines (y compris l'induction et le four).
- Contexte de thermodifusor sandwich (en acier inoxydable 18/10 - aluminium - en acier inoxydable).

- The entire piece (body, handles and mangoes) made of stainless steel 18/10.
- It favors a quick and homogeneous distribution of heat.
- Exterior bright polished finish and inner matt sanding.
- Maximum guarantee in terms of resistance, durability and hygiene.
- Suitable for all types of kitchens (including induction and oven).
- Sandwich thermodifusor background (stainless 18/10 - aluminum - stainless).

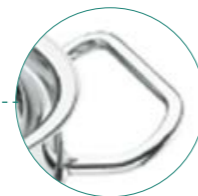

**Asas y mangos ergonómicos fabricados en acero inoxidable 18/10**  
Handles and grips are made in 18/10 stainless steel

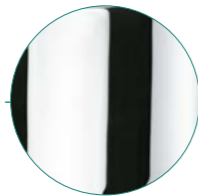

**Acabado pulido brillante exterior y lijado mate interior**  
Exterior glossy, polished finish and sanded matte interior

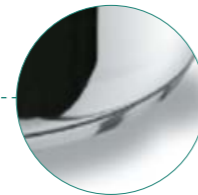

**Fondo termodifusor sandwich (inox 18/10 - aluminio - inoxidable)**  
Heat-diffusing sandwiched base (18/10 stainless steel - aluminium - st. Steel).



### Cacerola con tapa

Faitout a/couvercle · Bratentopf mit Deckel  
Casserole with lid · Caçarola com tampa

Ref	€	Ø (cm)	h(cm)	L	U.Venta
72016	52,70	16	8,0	1,50	1
72020	61,50	20	8,5	2,50	1
72024	72,00	24	9,5	3,50	1
72028	92,20	28	11,0	6,50	1
72032	125,10	32	12,5	9,00	1



### Olla con tapa

Marmite a/couvercle · Fleischtopf mit Deckel  
Stock pot with Lid · Panela com tampa

Ref	€	Ø (cm)	h(cm)	L	U.Venta
72116	56,90	16	13,0	2,50	1
72120	65,80	20	14,5	4,50	1
72124	79,10	24	15,0	6,50	1
72128	102,80	28	17,0	10,00	1



### Olla alta con tapa

Marmite S. Haute a/couvercle · Hoher Fleischtopf mit Deckel  
Deep Stock pot with Lid · Panela super alta com tampa

Ref	€	Ø (cm)	h(cm)	L	U.Venta
72125	86,40	24	20,0	9,00	1
72129	113,10	28	22,0	13,50	1



### Cazo

Casserole · Stielkasserole, flach  
Saucepan · Caçarola direita

Ref	€	Ø (cm)	h(cm)	L	U.Venta
72214	28,20	14	7,5	1,00	1
72216	31,90	16	8,0	1,50	1
72218	34,30	18	8,5	2,00	1
72220	38,60	20	8,5	2,50	1



### Pote cilíndrico

Pot-cilindrique · Milchtopf  
Cylindrical pot · Caneca cilíndrica

Ref	€	Ø (cm)	h(cm)	L	U.Venta
72714	33,20	14	12,5	1,50	1
72716	37,50	16	13,0	2,50	1



### Tapa

Couvercle · Deckel  
Lid · Tampa

Ref	€	Ø (cm)	U.Venta
72916	14,30	16	1
72920	17,40	20	1
72924	20,00	24	1
72928	25,90	28	1
72932	28,10	32	1



## Belly Collection

INOX 18/10



- Toda la pieza (cuerpo y asas) fabricada en acero inoxidable 18/10.
- Máxima garantía en cuanto a resistencia, durabilidad e higiene.
- El diseño de cuerpos bombeados proporciona mayor capacidad.
- Marcaje de capacidades en el interior (litros).
- Fondo termodifusor sándwich (inox 18/10 - aluminio - inoxidable).
- Distribución rápida y uniforme del calor.
- Apta para todos los fuegos (incluido inducción y horno).
- Incluye tapa de cristal resistente a los golpes con válvula y borde de acero inoxidable 18/10.

- La pièce entière (corps et poignées) en acier inoxydable 18/10.
- Garantie maximale en termes de résistance, de durabilité et d'hygiène.
- La conception des corps de pompage offre une plus grande capacité.
- Marquage de capacité à l'intérieur (litres).
- Contexte de thermofusor sandwich (en acier inoxydable 18/10 - aluminium - en acier inoxydable).
- Distribution rapide et uniforme de la chaleur.
- Convient à tous les incendies (y compris l'induction et le four).
- Comprend un couvercle en cristal résistant aux coups avec une soupape et un bord en acier inoxydable 18/10.

- The entire piece (body and handles) made of stainless steel 18/10.
- Maximum guarantee in terms of resistance, durability and hygiene.
- The design of pumping bodies provides greater capacity.
- Capacity marking inside (liters).
- Sandwich thermofusor background (stainless 18/10 - Aluminum - stainless).
- Quick and uniform distribution of heat.
- Suitable for all fires (including induction and oven).
- Includes crystal lid resistant to blows with valve and stainless steel edge 18/10.

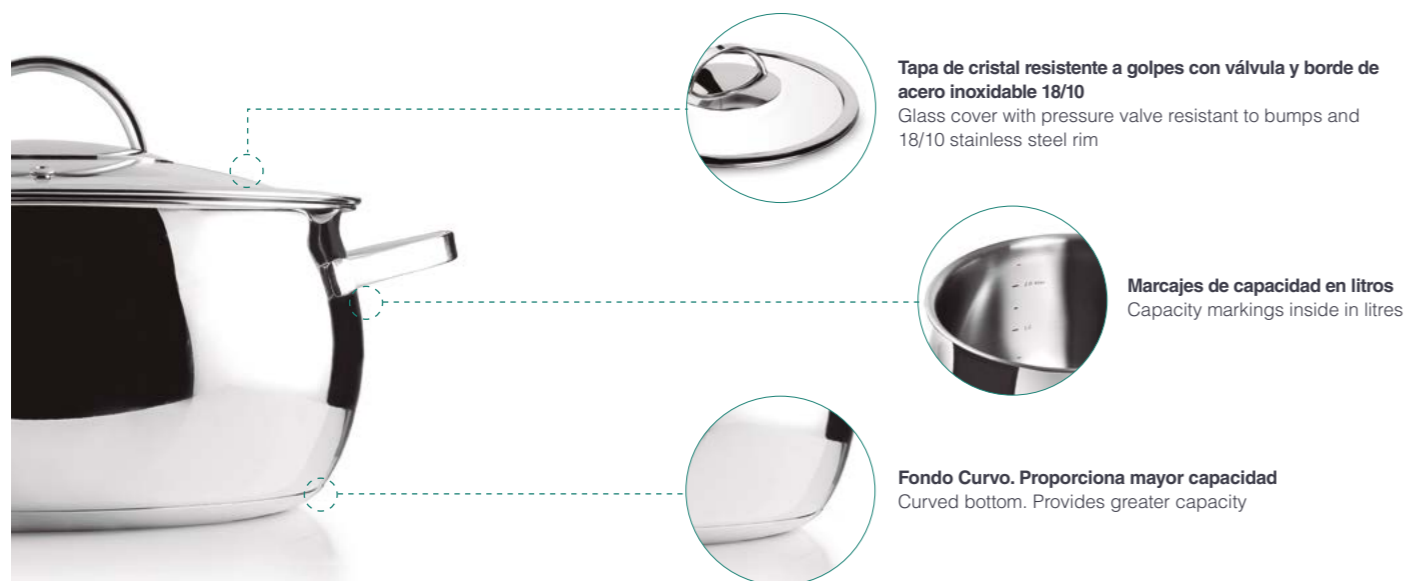

**Tapa de cristal resistente a golpes con válvula y borde de acero inoxidable 18/10**  
Glass cover with pressure valve resistant to bumps and 18/10 stainless steel rim

**Marcajes de capacidad en litros**  
Capacity markings inside in litres

**Fondo Curvo. Proporciona mayor capacidad**  
Curved bottom. Provides greater capacity



### Cacerola con tapa

Faitout avec couvercle · Bratentopf mit Deckel  
Casserole with lid · Caçarola com tampa

Ref	€	Ø (cm)	h(cm)	e (mm)	L	U.Venta
79016	38,80	16	8,5	0,6	1,20	1
79020	52,70	20	9,5	0,6	2,50	1
79024	71,80	24	11,5	0,7	4,40	1
79028	94,30	28	15,0	0,7	8,20	1



### Cazo

Casserole · Stielkasserole, flach  
Saucepan · Caçarola direite

Ref	€	Ø (cm)	h(cm)	e (mm)	L	U.Venta
79214	27,20	14	9,0	0,6	1,20	1
79216	31,70	16	9,5	0,6	1,60	1
79218	36,00	18	10,5	0,6	2,50	1
79220	41,50	20	11,5	0,6	3,50	1



### Cacerola vapor

Panier vapeur · Dampfkoch-Aufsatz  
Steam casserole · Caçarola a vapor

Ref	€	Ø (cm)	h(cm)	e (mm)	L	U.Venta
79420	33,80	20	9,5	0,6	3,00	1
79424	45,00	24	12,0	0,6	4,50	1



### Wok

Wok · Wok  
Wok · Wok

Ref	€	Ø (cm)	h(cm)	e (mm)	L	U.Venta
79830	60,90	30	10,0	0,7	4,50	4



### Olla con tapa

Marmite avec couvercle · Fleischtopf mit Deckel  
Stock pot with Lid · Panela com tampa

Ref	€	Ø (cm)	h(cm)	e (mm)	L	U.Venta
79116	43,40	16	10,0	0,6	1,60	1
79120	59,60	20	12,0	0,6	3,50	1
79124	76,40	24	14,0	0,6	5,50	1
79128	101,20	28	17,0	0,7	9,50	1



### Tartera con tapa

Plat rond avec couvercle · Pfanne mit Deckel  
Round dish with lid · Tarteira com tampa

Ref	€	Ø (cm)	h(cm)	e (mm)	L	U.Venta
79624	59,80	24	7,5	0,6	2,60	1
79628	75,90	28	7,5	0,7	3,00	1



### Pote

Pot · Milchtopf  
Pot · Caneca

Ref	€	Ø (cm)	h(cm)	e (mm)	L	U.Venta
79714	27,20	14	11,0	0,6	1,50	1



### Tapa

Couvercle · Deckel  
Lid · Tampa

Ref	€	Ø (cm)	U.Venta
79916	12,40	16	1
79920	16,60	20	1
79924	20,60	24	1
79928	25,90	28	1



# Vitrocor Collection



- Toda la pieza (cuerpo, asas y mangos) fabricada en acero inoxidable 18/10.
- Favorece una distribución rápida y homogénea del calor.
- Destaca por su diseño clásico, funcionalidad y sencillez.
- Acabado pulido brillante exterior y lijado mate interior.
- Apta para todo tipo de cocinas (incluido inducción y horno).
- Fondo termodifusor sándwich (inox 18/10 - aluminio - inox).
- Apta para el lavavajillas.

- Toute la pièce (corps, poignées et manches) est fabriquée en acier inoxydable 18/10.
- Favorise une distribution rapide et homogène de la chaleur.
- Se distingue par son style classique, sa fonctionnalité et sa simplicité.
- Finition extérieure polie brillante et intérieur limage mat.
- Compatible avec tout type de cuisinières (y compris induction et four).
- Fond thermo-diffuseur sandwich (inox 18/10 - aluminium - inox).
- Apte pour le lave-vaisselle.

- The whole product (body, handles and grips) is made in 18/10 stainless steel.
- It favours quick and homogeneous heat distribution.
- Stands out for its classic design, functionality and simplicity.
- Exterior glossy, polished finish and sanded matte interior.
- Suitable for all types of cooking surfaces (including induction and the oven).
- Sandwich heat diffuser (18/10 stainless steel - aluminium - stainless steel).
- Dishwasher safe.



## Cacerola con tapa

Faitout avec couvercle · Bratentopf mit Deckel  
Casserole with lid · Caçarola com tampa

Ref	€	Ø (cm)	h(cm)	L	U.Venta
40016	40,30	16	8,0	1,50	1
40018	43,90	18	8,5	2,00	1
40020	48,50	20	8,5	2,50	1
40022	53,20	22	9,0	3,00	1
40024	56,90	24	9,5	3,50	1
40026	64,50	26	9,5	4,50	1
40028	82,60	28	11,0	6,50	1
40032	104,10	32	12,5	9,50	1
40036	141,60	36	14,0	14,20	1
40040	164,30	40	15,5	19,50	1



## Cacerola vapor

Panier vapeur · Dampfkoch-Aufsatz  
Steam casserole · Caçarola a vapor

Ref	€	Ø (cm)	h(cm)	L	U.Venta
40420	36,00	20	8,5	2,50	1
40424	45,30	24	9,5	3,50	1
40428	49,70	28	11,0	6,50	1



## Olla con tapa

Marmite avec couvercle · Fleischtopf mit Deckel  
Stock pot with Lid · Panela com tampa

Ref	€	Ø (cm)	h(cm)	L	U.Venta
40116	45,30	16	13,0	2,50	1
40118	48,40	18	14,0	3,50	1
40120	52,80	20	14,5	4,50	1
40122	58,60	22	14,5	5,50	1
40124	65,80	24	15,0	6,50	1
40126	71,50	26	15,0	7,50	1
40128	90,40	28	17,0	10,00	1
40132	109,20	32	17,5	13,50	1
40136	154,80	36	21,5	22,00	1
40140	188,70	40	24,5	30,80	1



## Cuecepastas sin tapa

Cuit-pâte sans couvercle · Nudelkoch-Einsatz ohne Deckel  
Pasta cooker without lid · Coze-massas sem tampa

Ref	€	Ø (cm)	h(cm)	L	U.Venta
40426	68,30	24	17,5	9,50	1



## Olla alta con tapa

Marmite S. Haute a/couvercle · Hoher Fleischtopf mit Deckel  
Deep Stock pot with Lid · Panela super alta com tampa

Ref	€	Ø (cm)	h(cm)	L	U.Venta
40121	57,70	20	17,5	5,50	1
40125	75,10	24	20,0	9,00	1
40129	100,70	28	22,0	13,50	1
40133	149,10	32	28,0	22,50	1



## Pote cilíndrico

Pot-cilindrique · Milchtopf  
Cylindrical pot · Caneca cilíndrica

Ref	€	Ø (cm)	h(cm)	L	U.Venta
40712	29,80	12	12,0	1,00	1
40714	31,90	14	12,5	1,50	1
40716	35,00	16	13,0	2,50	1
40718	38,70	18	14,0	3,50	1



## Sartén

Poêle · Pflanne  
Frying pan · Sertã

Ref	€	Ø (cm)	h(cm)	e (mm)	U.Venta
40619	33,80	18	4,5	0,7	1
40621	36,00	20	4,5	0,7	1
40623	37,30	22	5,0	0,7	1
40625	39,90	24	5,2	0,7	1
40627	41,10	26	6,0	0,7	1
40629	44,10	28	6,5	0,7	1



## Escurridera

Passoire sur pied · Abtropfschüssel  
Colander with stand · Escorredor

Ref	€	Ø (cm)	h(cm)	U.Venta
40324	50,20	24	11,0	1



## Colador esférico

Passoire sur pied · Abtropfschüssel  
Colander with stand · Escorredor

Ref	€	Ø (cm)	h(cm)	U.Venta
40318	32,20	18	8,5	1



## Cazo

Casserole · Stielkasserole, flach  
Saucepan · Caçarola direite

Ref	€	Ø (cm)	h(cm)	L	U.Venta
40212	25,30	12	7,0	0,80	1
40214	26,20	14	7,5	1,00	1
40216	29,70	16	8,0	1,50	1
40218	32,40	18	8,5	2,00	1
40220	37,60	20	8,5	2,50	1



## Tartera con tapa

Plat rond avec couvercle · Pflanne mit Deckel  
Round dish with lid · Tarteira com tampa

Ref	€	Ø (cm)	h(cm)	L	U.Venta
40620	48,40	20	6,5	2,00	1
40622	51,50	22	6,5	2,50	1
40624	56,70	24	7,0	3,00	1
40626	61,40	26	7,0	3,50	1
40628	76,60	28	8,0	4,50	1
40632	93,00	32	8,0	6,00	1
40636	123,30	36	8,5	7,50	1
40640	142,50	40	8,5	11,00	1



## Tapa

Couvercle · Deckel  
Lid · Tampa

Ref	€	Ø (cm)	U.Venta
40916	10,90	16	1
40918	11,10	18	1
40920	11,70	20	1
40922	12,40	22	1
40924	13,70	24	1
40926	14,60	26	1
40928	18,40	28	1
40932	23,00	32	1
40936	30,80	36	1
40940	35,00	40	1



## Gourmet Collection

INOX 18/10



- Toda la pieza (cuerpo, asas y mangos) fabricada en acero inoxidable 18/10.
- Favorece una distribución rápida y homogénea del calor.
- Extremadamente robusta.
- Acabado pulido brillante exterior y lijado mate interior.
- Apta para todo tipo de cocinas (incluido inducción y horno).
- Triple fondo difusor que asegura un eficiente reparto del calor.

- Toute la pièce (corps, poignées et manches) est fabriquée en acier inoxydable 18/10.
- Favorise une distribution rapide et homogène de la chaleur.
- Extrêmement robustes.
- Finition extérieure polie brillante et intérieur limage mat.
- Compatible avec tout type de cuisinières (y compris induction et four).
- Triple fond diffuseur qui garantit une répartition efficace de la chaleur.

- The whole product (body, handles and grips) is made in 18/10 stainless steel.
- It favours quick and homogeneous heat distribution.
- Extremely robust.
- Exterior glossy, polished finish and sanded matte interior.
- Suitable for all types of cooking surfaces (including induction and the oven).
- Triple diffuser bottom assuring efficient distribution of heat.



### Cacerola con tapa

Faitout avec couvercle · Bratentopf mit Deckel  
Casserole with lid · Caçarola com tampa

Ref	€	Ø (cm)	h(cm)	L	U.Venta
90016	44,80	16	8,0	1,50	1
90018	48,00	18	8,5	2,00	1
90020	52,70	20	8,5	2,50	1
90022	57,10	22	9,0	3,00	1
90024	61,70	24	9,5	3,50	1
90026	69,20	26	9,5	4,50	1
90028	85,00	28	11,0	6,50	1
90032	105,60	32	12,5	9,50	1



### Olla con tapa

Marmite avec couvercle · Fleischtopf mit Deckel  
Stock pot with Lid · Panela com tampa

Ref	€	Ø (cm)	h(cm)	L	U.Venta
90116	49,10	16	13,0	2,50	1
90118	53,10	18	14,0	3,50	1
90120	56,30	20	14,5	4,50	1
90122	62,70	22	14,5	5,50	1
90124	69,40	24	15,0	6,50	1
90126	74,90	26	15,0	7,50	1
90128	93,10	28	17,0	10,00	1
90132	120,60	32	17,5	13,50	1



### Olla alta con tapa

Marmite S. Haute a/couvercle · Hoher Fleischtopf mit Deckel  
Deep Stock pot with Lid · Panela super alta com tampa

Ref	€	Ø (cm)	h(cm)	L	U.Venta
90125	79,70	24	20,0	9,00	1
90129	103,50	28	22,0	13,50	1



### Cacerola vapor

Panier vapeur · Dampfkoch-Aufsatz  
Steam casserole · Caçarola a vapor

Ref	€	Ø (cm)	h(cm)	L	U.Venta
90420	40,80	20	8,5	2,50	1
90424	50,10	24	9,5	3,50	1



### Tartera con tapa

Plat rond a/couvercle · Pfanne mit Deckel  
Round dish with lid · Tarteira com tampa

Ref	€	Ø (cm)	h(cm)	L	U.Venta
90620	52,70	20	6,5	2,00	1
90622	56,40	22	6,5	2,50	1
90624	60,30	24	7,0	3,00	1
90626	65,30	26	7,0	3,50	1
90628	77,80	28	8,0	4,50	1
90632	96,80	32	8,0	6,00	1



### Pote cilíndrico

Pot-cilindrique · Milchtopf  
Cylindrical pot · Caneca cilíndrica

Ref	€	Ø (cm)	h(cm)	L	U.Venta
90712	30,40	12	12,0	1,00	1
90714	32,20	14	12,5	1,50	1
90716	36,20	16	13,0	2,50	1
90718	39,10	18	14,0	3,50	1



### Cazo

Casserole · Stielkasserole, flach  
Saucepan · Caçarola direite

Ref	€	Ø (cm)	h(cm)	L	U.Venta
90212	27,30	12	7,0	0,80	1
90214	28,90	14	7,5	1,00	1
90216	32,40	16	8,0	1,50	1
90218	35,00	18	8,5	2,00	1
90220	39,20	20	8,5	2,50	1



### Colador esférico

Passoire à queue · Seiher, mit Stiel  
Strainer · Coador esférico

Ref	€	Ø (cm)	h(cm)	U.Venta
90318	32,20	18	8,5	1



### Escurridera

Passoire à queue · Seiher, mit Stiel  
Strainer · Coador esférico

Ref	€	Ø (cm)	h(cm)	U.Venta
90324	48,70	24	11,0	1



### Tapa

Couvercle · Deckel  
Lid · Tampa

Ref	€	Ø (cm)	U.Venta
90916	12,00	16	1
90918	12,00	18	1
90920	12,10	20	1
90922	12,30	22	1
90924	13,60	24	1
90926	14,60	26	1
90928	19,10	28	1
90932	24,70	32	1





**Pomo abatible**  
Folding knob



## Estudio Collection



- **Cuerpo fabricado en acero inoxidable 18/10.**
- **Asas, mangos y pomo en baquelita termoaislante.**
- **Su pomo abatible consigue una reducción del espacio manteniendo una ergonomía perfecta.**
- **Acabado pulido brillante exterior y lijado mate interior.**
- **Triple fondo difusor que asegura un eficiente reparto del calor.**
- **Apta para todo tipo de cocinas (incluido inducción). Apta para el lavavajillas.**

- Corps en acier inoxydable 18/10.
- Poignées, mangues et bouton dans Thermoslante Baquelita.
- Son KNN pliant réalise une réduction de l'espace en maintenant une ergonomie parfaite.
- Finition extérieure et polie et ponçage de Matt intérieur.
- Contexte triple diffuseur qui garantit une distribution de chaleur efficace.
- Convient à tous les types de cuisines (y compris l'induction). Convient au lave-vaisselle.

- Body made of stainless steel 18/10.
- Handles, mangoes and knob in thermoslante baquelita.
- Its folding knn achieves a reduction in space maintaining a perfect ergonomics.
- Exterior bright polished finish and inner matt sanding.
- Triple diffuser background that ensures efficient heat distribution.
- Suitable for all types of kitchens (including induction). Suitable for dishwasher.



### Cacerola con tapa

Faitout avec couvercle · Bratentopf mit Deckel  
Casserole with lid · Caçarola com tampa

Ref	€	Ø (cm)	h(cm)	L	U.Venta
85016	46,10	16	8,0	1,50	1
85018	49,70	18	8,5	2,00	1
85020	54,20	20	8,5	2,50	1
85022	58,20	22	9,0	3,00	1
85024	62,80	24	9,5	3,50	1
85026	68,50	26	9,5	4,50	1
85028	78,90	28	11,0	6,50	1



### Olla con tapa

Marmite a/couvercle · Fleischtopf mit Deckel  
Stock pot with Lid · Panela com tampa

Ref	€	Ø (cm)	h(cm)	L	U.Venta
85118	52,90	18	14,0	3,50	1
85120	58,10	20	14,5	4,50	1
85122	63,50	22	14,5	5,50	1
85124	69,60	24	15,0	6,50	1
85126	74,90	26	15,0	7,50	1
85128	88,40	28	17,0	10,00	1



### Olla alta con tapa

Marmite S. Haute a/couvercle · Hoher Fleischtopf mit Deckel  
Deep Stock pot with Lid · Panela super alta com tampa

Ref	€	Ø (cm)	h(cm)	L	U.Venta
85125	79,10	24	20,0	9,00	1
85129	97,60	28	22,0	13,50	1



### Cacerola vapor

Panier vapeur · Dampfkoch-Aufsatz  
Steam casserole · Caçarola a vapor

Ref	€	Ø (cm)	h(cm)	L	U.Venta
85420	40,70	20	9,0	2,50	1
85424	49,80	24	10,5	3,50	1



### Pote cilíndrico

Pot-cilindrique · Milchtopf  
Cylindrical pot · Caneca cilíndrica

Ref	€	Ø (cm)	h(cm)	L	U.Venta
85712	30,30	12	12,0	1,00	1
85714	32,50	14	12,5	1,50	1
85716	34,40	16	13,0	2,50	1
85718	38,20	18	14,0	3,50	1



### Tapa

Couvercle · Deckel  
Lid · Tampa

Ref	€	Ø (cm)	U.Venta
85916	9,40	16	1
85918	10,20	18	1
85920	11,20	20	1
85922	11,40	22	1
85924	12,60	24	1
85926	13,20	26	1
85928	17,00	28	1



### Cazo

Casserole · Stielkasserole, flach  
Saucepan · Caçarola direite

Ref	€	Ø (cm)	h(cm)	L	U.Venta
85212	26,80	12	7,0	0,80	1
85214	28,10	14	7,5	1,00	1
85216	30,80	16	8,0	1,50	1
85218	34,20	18	8,5	2,00	1
85220	38,50	20	8,5	2,50	1



### Sautex

Sauteuse · Sauteuse  
Sauteuse · Frigideira

Ref	€	Ø (cm)	h(cm)	L	U.Venta
85624	41,50	24	7,0	3,50	1



### Sartén

Poêle · Pfanne  
Frying pan · Sertás

Ref	€	Ø (cm)	h(cm)	L	U.Venta
85625	39,20	24	7,0	3,50	1
85629	42,60	28	8,0	4,50	1



### Lote 5 cazos

Ensemble 5 casseroles · Set 5 Tlg. Stielkasserollen  
Set 5 saucepans · Lote de 5 caçarola

Ref	€	Ø (cm)	U.Venta
85003	158,30	12	1
		14	
		16	
		18	
		20	



# Nova-Ladycor Collection



- **Cuerpo fabricado en acero inoxidable 18/10.**
- **Asas, mangos y pomo en baquelita termoaislante.**
- **Destaca por su diseño clásico, funcionalidad y sencillez.**
- **Acabado pulido brillante exterior y lijado mate interior.**
- **Triple fondo difusor que asegura un eficiente reparto del calor.**
- **Apta para todo tipo de cocinas (incluido inducción). Apta para el lavavajillas.**

- Corps en acier inoxydable 18/10.
- Poignées, mangues et bouton dans Thermoslante Baquelita.
- Il se distingue par sa conception classique, sa fonctionnalité et sa simplicité.
- Finition extérieure et polie et ponçage de Matt intérieur.
- Contexte triple diffuseur qui garantit une distribution de chaleur efficace.
- Convient à tous les types de cuisines (y compris l'induction). Convient au lave-vaisselle.

- Body made of stainless steel 18/10.
- Handles, mangoes and knob in thermoslante baquelita.
- It stands out for its classic design, functionality and simplicity.
- Exterior bright polished finish and inner matt sanding.
- Triple diffuser background that ensures efficient heat distribution.
- Suitable for all types of kitchens (including induction). Suitable for dishwasher.



**Cacerola con tapa**  
Faitout avec couvercle · Bratentopf mit Deckel  
Casserole with lid · Caçarola com tampa

Ref	€	Ø (cm)	h(cm)	L	U.Venta
88016	45,60	16	8,0	1,50	1
88018	48,80	18	8,5	2,00	1
88020	53,10	20	8,5	2,50	1
88022	58,10	22	9,0	3,00	1
88024	62,00	24	9,5	3,50	1
88026	69,60	26	9,5	4,50	1
88028	84,60	28	11,0	9,50	1
88032	107,70	32	12,5	9,50	1



**Olla con tapa**  
Marmite avec couvercle · Fleischtopf mit Deckel  
Stock pot with Lid · Panela com tampa

Ref	€	Ø (cm)	h(cm)	L	U.Venta
88116	50,20	16	13,0	2,50	1
88118	53,00	18	14,0	3,50	1
88120	56,70	20	14,5	4,50	1
88122	62,00	22	14,5	5,50	1
88124	69,30	24	15,0	6,50	1
88126	77,00	26	15,0	7,50	1
88128	93,80	28	17,0	10,00	1
88132	113,20	32	17,5	13,50	1



**Olla alta con tapa**  
Marmite S. Haute a/couvercle · Hoher Fleischtopf mit Deckel  
Deep Stock pot with Lid · Panela super alta com tampa

Ref	€	Ø (cm)	h(cm)	L	U.Venta
88121	61,90	20	17,5	5,50	1
88125	78,80	24	20,0	9,00	1
88129	110,90	28	22,0	13,50	1



**Cazo vapor**  
Panier vapeur · Dampfkoch-Aufsatz  
Steam casserole · Caçarola a vapor

Ref	€	Ø (cm)	h(cm)	L	U.Venta
88420	42,40	20	9,0	2,50	1
88424	52,10	24	10,5	3,50	1



**Pote cilíndrico**  
Pot-cilindrique · Milchtopf  
Cylindrical pot · Caneca cilíndrica

Ref	€	Ø (cm)	h(cm)	L	U.Venta
88712	29,70	12	12,0	1,00	1
88714	32,20	14	12,5	1,50	1
88716	35,10	16	13,0	2,50	1
88718	38,70	18	14,0	3,50	1



**Colador esférico**  
Passoire à queue · Seiher, mit Stiel  
Strainer · Coador esférico

Ref	€	Ø (cm)	h(cm)	U.Venta
88318	34,70	18	8,5	1



**Cazo**  
Casserole · Stielkasserole, flach  
Saucepan · Caçarola direite

Ref	€	Ø (cm)	h(cm)	L	U.Venta
88212	27,10	12	7,0	0,80	1
88214	28,10	14	7,5	1,00	1
88216	30,80	16	8,0	1,50	1
88218	33,80	18	8,5	2,00	1
88220	38,70	20	8,5	2,50	1



**Tartera con tapa**  
Plat rond avec couvercle · Pfanne mit Deckel  
Round dish with lid · Tarteira com tampa

Ref	€	Ø (cm)	h(cm)	L	U.Venta
88620	52,70	20	6,5	2,00	1
88622	56,70	22	6,5	2,50	1
88624	60,80	24	7,0	3,00	1
88626	65,40	26	7,0	3,50	1
88628	74,50	28	8,0	4,50	1
88632	95,10	32	8,0	6,00	1



**Tapa**  
Couvercle · Deckel  
Lid · Tampa

Ref	€	Ø (cm)	U.Venta
88916	10,70	16	1
88918	10,90	18	1
88920	11,50	20	1
88922	11,80	22	1
88924	12,60	24	1
88926	14,20	26	1
88928	17,60	28	1
88932	24,00	32	1



**Escurridera**  
Passoire sur pied · Abtropfschüssel  
Colander with stand · Escorredor

Ref	€	Ø (cm)	h(cm)	U.Venta
88324	49,10	24	11,0	1

# Caliza Collection

new



- **Cuerpo fabricado en acero inoxidable 18/10.**
- **Asas, mangos y pomo en baquelita termoaislante.**
- **Acabado pulido brillante exterior y lijado mate interior.**
- **Triple fondo difusor que asegura un eficiente reparto del calor.**
- **Apta para todo tipo de cocinas (incluida inducción).**
- **Apta para el lavavajillas.**

- Corps fabriqué en acier inoxydable 18/10.
- Poignées, manches et pommeau en bakélite thermo-isolante.
- Finition polie brillante extérieur et limage mat intérieur.
- Triple fond diffuseur qui garantit une répartition efficace de la chaleur.
- Compatible avec tout type de cuisinières (y compris induction).
- Apte pour le lave-vaisselle.

- Body made in 18/10 stainless steel.
- Handles, grips and knob in heat resistant bakelite.
- Exterior glossy, polished finish and sanded matte interior.
- Triple diffuser bottom assuring efficient distribution of heat.
- Suitable for all types of cooking surfaces (including induction).
- Dishwasher safe.



**Cacerola con tapa**  
Faitout avec couvercle · Bratentopf mit Deckel  
Casserole with lid · Caçarola com tampa

Ref	€	Ø (cm)	h(cm)	L	U.Venta
80016	45,60	16	8,0	1,50	1
80018	48,70	18	8,5	2,00	1
80020	53,10	20	8,5	2,50	1
80022	58,10	22	9,0	3,00	1
80024	62,00	24	9,5	3,50	1
80026	69,50	26	9,5	4,50	1
80028	84,60	28	11,0	9,50	1



**Olla con tapa**  
Marmite avec couvercle · Fleischtopf mit Deckel  
Stock pot with Lid · Panela com tampa

Ref	€	Ø (cm)	h(cm)	L	U.Venta
80116	50,20	16	13,0	2,50	1
80118	52,90	18	14,0	3,50	1
80120	56,60	20	14,5	4,50	1
80122	62,00	22	14,5	5,50	1
80124	69,30	24	15,0	6,50	1
80126	77,00	26	15,0	7,50	1
80128	93,70	28	17,0	10,00	1



**Cazo**  
Casserole · Stielkasserole, flach  
Saucepan · Caçarola direita

Ref	€	Ø (cm)	h(cm)	L	U.Venta
80212	27,10	12	7,0	0,80	1
80214	28,00	14	7,5	1,00	1
80216	30,80	16	8,0	1,50	1
80218	33,80	18	8,5	2,00	1



**Tartera con tapa**  
Plat rond avec couvercle · Pflanne mit Deckel  
Round dish with lid · Tarteira com tampa

Ref	€	Ø (cm)	h(cm)	L	U.Venta
80624	60,70	24	7,0	3,00	1
80626	65,40	26	7,0	3,50	1
80628	74,40	28	8,0	4,50	1



**Pote cilíndrico**  
Pot-cylindrique · Milchtopf  
Cylindrical pot · Caneca cilíndrica

Ref	€	Ø (cm)	h(cm)	L	U.Venta
80714	32,10	14	12,5	1,50	1
80716	35,10	16	13,0	2,50	1
80718	38,70	18	14,0	3,50	1



**Tapa**  
Couvercle · Deckel  
Lid · Tampa

Ref	€	Ø (cm)	U.Venta
80916	10,70	16	1
80918	10,90	18	1
80920	11,50	20	1
80922	11,80	22	1
80924	12,60	24	1
80926	14,20	26	1
80928	17,50	28	1

# Garinox Collection



- **Cuerpo fabricado en acero inoxidable 18/10.**
- **Asas, mangos y pomo en baquelita termoaislante.**
- **Acabado pulido brillante.**
- **Fondo Termomodifusor (inox 18/10 - aluminio - inox).**
- **Apta para todo tipo de cocinas (incluido inducción).**
- **Apta para el lavavajillas.**

- Corps en acier inoxydable 18/10.
- Poignées, mangues et bouton dans Thermoslante Baquelita.
- Finition polie brillante.
- Fond thermomodifusor (acier inoxydable 18/10 - aluminium - inoxydable).
- Convient à tous les types de cuisines (y compris l'induction).
- Convient au lave-vaisselle.

garinox®

- Body made of stainless steel 18/10.
- Handles, mangoes and knob in thermoslante baquelita.
- Bright polished finish.
- Thermomodifusor background (stainless 18/10 - aluminum - stainless).
- Suitable for all types of kitchens (including induction).
- Suitable for dishwasher.



**Cacerola con tapa**  
Faitout a/couvercle · Bratentopf mit Deckel  
Casserole with lid · Caçarola com tampa

Ref	€	Ø (cm)	h(cm)	e (mm)	L	U.Venta
14318	29,40	18	9,0	0,5	2,00	1
14320	33,90	20	10,0	0,5	3,00	1
14322	40,10	22	11,0	0,5	4,00	1
14324	46,20	24	12,0	0,5	5,00	1



**Olla con tapa**  
Marmite avec couvercle · Fleischtopf mit Deckel  
Stock pot with Lid · Panela com tampa

Ref	€	Ø (cm)	h(cm)	e (mm)	L	U.Venta
14420	36,40	20	12,0	0,5	3,80	1
14422	42,60	22	13,0	0,5	5,00	1
14424	51,10	24	15,0	0,5	7,00	1

**Cazo 18/10**  
Casserole · Stielkasserole, flach  
Saucepan · Caçarola direita

Ref	€	Ø (cm)	h(cm)	e (mm)	L	U.Venta
14212	10,50	12	5,5	0,5	0,60	1
14214	13,00	14	6,5	0,5	1,50	1
14216	16,20	16	7,5	0,5	1,50	1
14218	19,60	18	9,0	0,5	2,00	1
14220	23,10	20	10,0	0,5	3,00	1



**Ideal para calentar leche, chocolate y salsas**  
Ideal for heating milk, making chocolate and sauces

Mango de baquelita termoaislante  
Heat-insulating bakelite handle



INOX

**Cazo Inox**  
Casserole · Stielkasserole  
Saucepan · Caçarole

Ref	€	Ø (cm)	h(cm)	L	U.Venta
31212	9,30	12	6,5	0,50	1
31214	10,70	14	7,0	1,00	1
31216	11,90	16	7,5	1,50	1
31218	13,60	18	8,0	2,00	1
31220	14,60	20	8,0	2,50	1

Mango de baquelita termoaislante  
Heat-insulating bakelite handle

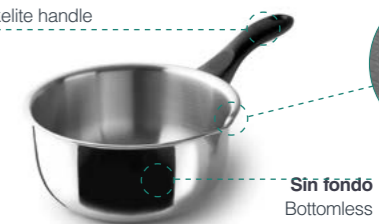

INOX

**Cazo Vertedor**  
Casserole · Stielkasserole  
Saucepan · Caçarole de verter

Ref	€	Ø (cm)	h(cm)	L	U.Venta
31312	9,70	12	6,5	0,50	1
31314	11,00	14	7,0	1,00	1
31316	12,20	16	7,5	1,50	1
31318	13,90	18	8,0	2,00	1
31320	14,50	20	8,0	2,50	1

Pico vertedor  
Pouring spout.

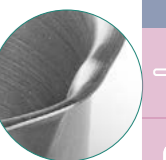

Sin fondo  
Bottomless



# Basic Collection



- **Toda la pieza (cuerpo, asas y mangos) fabricada en acero inoxidable.**
- **La tapa, con cierre de precisión, preserva los aromas y retiene el calor.**
- **Ideal para cocinar de forma saludable y ahorrar energía.**
- **Acabado interior lijado satinado y exterior pulido brillante.**
- **Apta para todo tipo de cocinas (incluido inducción y horno).**
- **Apta para el lavavajillas.**

- La pièce entière (corps, poignées et mangues) en acier inoxydable.
- Le couvercle, avec fermeture de précision, conserve les arômes et conserve la chaleur.
- Idéal pour cuisiner de manière saine et économiser de l'énergie.
- Finition intérieure satinée et extérieure et polie brillante.
- Convient à tous les types de cuisines (y compris l'induction et le four).
- Convient au lave-vaisselle.

- The entire piece (body, handles and mangoes) made of stainless steel.
- The lid, with precision closure, preserves the aromas and retains heat.
- Ideal to cook in a healthy way and save energy.
- Satinated and exterior interior finish and bright polished.
- Suitable for all types of kitchens (including induction and oven).
- Suitable for dishwasher.



**Cacerola con tapa**  
Faitout a/couvercle · Bratentopf mit Deckel  
Casserole with lid · Caçarola com tampa

Ref	€	Ø (cm)	h(cm)	e (mm)	L	U.Venta
32016	33,30	16	8,0	0,7	1,50	1
32020	40,50	20	8,5	0,7	2,50	1
32024	50,20	24	9,5	0,7	3,50	1
32028	64,90	28	11,0	0,8	6,50	1



**Olla alta con tapa**  
Marmite S. Haute a/couvercle · Hoher Fleischtopf mit Deckel  
Deep Stock pot with Lid · Panela super alta com tampa

Ref	€	Ø (cm)	h(cm)	e (mm)	L	U.Venta
32125	69,70	24	20,0	0,7	9,00	1
32129	87,90	28	22,5	0,7	13,50	1



**Olla con tapa**  
Marmite avec couvercle · Fleischtopf mit Deckel  
Stock pot with Lid · Panela com tampa

Ref	€	Ø (cm)	h(cm)	e (mm)	L	U.Venta
32116	40,50	16	13,0	0,7	2,50	1
32120	44,90	20	13,5	0,7	4,50	1
32124	56,80	24	15,0	0,7	6,50	1
32128	73,90	28	17,0	0,7	10,00	1



**Cazo**  
Pot-cilindrique · Milchtopf  
Cylindrical pot · Caneca cilíndrica

Ref	€	Ø (cm)	h(cm)	e (mm)	L	U.Venta
32214	19,70	14	7,5	0,7	1,00	1
32216	22,80	16	8,0	0,7	1,50	1
32218	25,30	18	8,5	0,7	2,00	1
32220	28,80	20	8,5	0,7	2,50	1



**Cacerola vapor**  
Panier vapeur · Dampfkoch-Aufsatz  
Steam casserole · Caçarola a vapor

Ref	€	Ø (cm)	h(cm)	e (mm)	L	U.Venta
32420	25,80	20	8,5	0,7	2,50	1
32424	30,20	24	9,5	0,7	3,50	1



**Pote cilíndrico**  
Pot-cilindrique · Milchtopf  
Cylindrical pot · Caneca cilíndrica

Ref	€	Ø (cm)	h(cm)	e (mm)	L	U.Venta
32714	25,30	14	12,5	0,7	1,50	1
32716	29,60	16	13,0	0,7	2,50	1



**Tapa**  
Couvercle · Deckel  
Lid · Tampa

Ref	€	Ø (cm)	e (mm)	U.Venta
32916	9,60	16	0,7	1
32920	11,50	20	0,7	1
32924	13,50	24	0,7	1
32928	16,90	28	0,7	1



**Cuscusera**  
Couscoussier · Couscous-Maschine  
Couscouss maker · Máquina de fazer cuscuz

Ref	€	Ø (cm)	h (cm)	U.Venta
32520	20,40	20	8,5	1
32524	24,80	24	9,5	1



**Tartera con tapa**  
Plat rond avec couvercle · Pfanne mit Deckel  
Round dish with lid · Tarteira com tampa

Ref	€	Ø (cm)	h(cm)	e (mm)	L	U.Venta
32624	42,10	24	7,0	0,7	3,00	1
32628	59,10	28	8,0	0,7	4,50	1



**Lote 4 cazos**  
Ensemble 4 casseroles · Set 4 Tlg. Stielkasserollen  
Set 4 saucepans · Lote de 4 caçarola

Ref	€	Ø (cm)	U.Venta
32003	95,60	14	1
		16	
		18	
		20	



**Colador esférico**  
Passoire à queue · Seiher, mit Stiel  
Strainer · Coador esférico

Ref	€	Ø (cm)	h(cm)	e (mm)	U.Venta
32318	38,70	18	8,5	0,7	1



**Escurridera**  
Passoire sur pied · Abtropfschüssel  
Colander with stand · Escorredor

Ref	€	Ø (cm)	h(cm)	e (mm)	U.Venta
32324	53,60	24	11,0	0,7	1



- **Fabricada en acero inoxidable 18/10 de gran calidad.**
- **Acabado interior satinado y exterior brillo.**
- **Garantía máxima en cuanto a resistencia, durabilidad e higiene.**
- **Versátil: diseñado para cocinar cuscús y alimentos al vapor. También puede utilizarse como escurridera.**
- **Fondo perforado con agujeros de Ø2,5 mm.**
- **Excelente absorción y reparto del calor, proporciona unos resultados perfectos conservando las propiedades nutritivas y sabor atural de los alimentos**
- **Se adapta perfectamente a ollas y cacerolas del mismo diámetro.**
- **Asas de acero inoxidable de diseño ergonómico con acabado pulido brillante.**

- Made of high quality 18/10 stainless steel.
- Satin interior and glossy exterior finish.
- Maximum guarantee in terms of resistance, durability and hygiene.
- Versatile: designed for cooking couscous and steamed food.
- Can also be used as a colander.
- Perforated bottom with Ø2.5 mm holes.
- Excellent heat absorption and heat distribution, providing perfect results while preserving the nutritional properties and natural flavour of the food.
- Ergonomically designed stainless steel handles with bright polished finish.



# Forte Collection



- Fabricada en aluminio fundido y construida en una sola pieza.
- Máxima robustez y gran resistencia a la deformación.
- Ideal para guisos, cocidos, sopas y salsas.
- Revestimiento antiadherente interior y exterior, libre de PFOA.
- Apta para todo tipo de cocinas (incluido inducción).
- Incluye una tapa de vidrio templado con válvula resistente a los golpes.

- Fabriqué en aluminium fondu et construit en une seule pièce.
- Robustesse maximale et grande résistance à la déformation.
- Idéal pour les ragoûts, cuits, les soupes et les sauces.
- Revêtement anti-anti-intérieur et extérieur, exempt de PFOA.
- Convient à tous les types de cuisines (y compris l'induction).
- Comprend un couvercle en verre trempé avec une valve résistante à un coup.

- Manufactured in molten and built aluminum in one piece.
- Maximum robustness and great resistance to deformation.
- Ideal for stews, cooked, soups and sauces.
- Interior and exterior antiating coating, free of PFOA.
- Suitable for all types of kitchens (including induction).
- Includes a tempered glass lid with blow-resistant valve.



## Cacerola con tapa

Faitout avec couvercle verre · Bratentopf mit Glasdeckel  
Round casserole with glass lid · Caçarola com tampa de vidro

Ref	€	Ø (cm)	h(cm)	L	U.Venta
25816	32,50	16	8,5	1,20	1
25820	35,10	20	8,5	2,20	1
25824	43,90	24	10,5	4,40	1
25828	53,70	28	12,5	6,40	1
25831	63,80	30	13,5	8,40	1



## Cacerola cuadrada con tapa

Faitout carré avec couvercle verre · Bratentopf mit Glasdeckel  
Square casserole with glass lid · Caçarola quadrada com tampa de vidro

Ref	€	cm	h(cm)	L	U.Venta
25829	63,50	28x28	12,0	7,5	1

## Cacerola baja con tapa

Faitout bas avec couvercle verre · Bratentopf mit Glasdeckel  
Round low casserole with glass lid · Caçarola baixa com tampa de vidro

Ref	€	Ø (cm)	h(cm)	L	U.Venta
25823	44,10	24	7,5	2,30	1
25827	54,00	28	7,5	3,70	1
25832	70,00	32	7,5	5,70	1
25835	81,00	36	8,5	7,40	1

# Stilo Collection

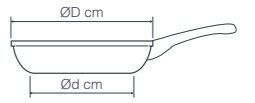

- Fabricada en aluminio fundido de gran calidad y espesor.
- Recubrimiento antiadherente acabado en partículas de piedra, libre de materiales tóxicos y pesados. Ecológico y libre de PFOA.
- La base de aluminio permite una distribución homogénea del calor, permitiendo que los alimentos se cocinen rápidamente y de manera uniforme, sin apenas utilizar aceite.
- Máxima resistencia al desgaste.
- Fácil limpieza interior y exterior gracias a su protección antiadherente.
- Compatibilidad: todo tipo de cocinas, incluida la inducción.
- Pomo y asas ergonómicas con acabado Soft Touch.
- Tapa de cristal con borde de silicona.

- Fabriqué en aluminium fondu de haute qualité et épaisseur.
- Finition de revêtement anticaracte dans les particules de pierre, exemptes de matériaux toxiques et lourds. Écologique et sans PFOA.
- La base en aluminium permet une distribution homogène de la chaleur, permettant aux aliments de cuire rapidement et uniformément, avec presque aucune huile.
- Résistance à l'usure maximale.
- Nettoyage intérieur et extérieur facile grâce à sa protection non-assise.
- Compatibilité: tous les types de cuisines, y compris l'induction.
- Poignées pomotives et ergonomiques avec finition tactile douce.
- Couvercle en cristal avec bord de silicone.

- Manufactured in molten aluminum of high quality and thickness.
- Antiating coating Finish in stone particles, free of toxic and heavy materials. Ecological and free of PFOA.
- The aluminum base allows a homogeneous distribution of heat, allowing food to cook quickly and uniformly, with hardly any oil.
- Maximum wear resistance.
- Easy interior and exterior cleaning thanks to its non-stick protection.
- Compatibility: all types of kitchens, including induction.
- Pomotive and ergonomic handles with soft touch finish.
- Crystal lid with silicone edge.



## Cacerola con tapa

Faitout avec couvercle verre · Bratentopf mit Glasdeckel  
Casserole with glass lid · Caçarola com tampa de vidro

Ref	€	Ø (cm)	h(cm)	L	U.Venta
27320	53,50	20	10,5	2,50	1
27324	62,00	24	12,0	4,00	1
27328	73,20	28	12,5	6,00	1



## Cazo

Casserole · Stielkasserole, flach  
Saucepan · Caçarola direita

Ref	€	Ø (cm)	h(cm)	L	U.Venta
27416	34,10	16	7,5	1,20	1
27418	36,40	18	8,8	1,80	1

Válvula salida de vapor  
Steam outlet valve

Aro protector de silicona  
Silicone protective ring



## Tapa

Couvercle verre · Glasdeckel  
Glass lid · Tampa de vidro

Ref	€	Ø (cm)	U.Venta
27920	9,20	20	1
27924	10,60	24	1
27928	13,00	28	1

## Tartera con tapa

Faitout bas avec couvercle verre · Bratentopf mit Glasdeckel  
Low casserole with glass lid · Caçarola baixa com tampa de vidro

Ref	€	Ø (cm)	h(cm)	L	U.Venta
27327	69,30	28	8,5	4,00	1



## Sartén

Poêle · Pfanne  
Frying pan · Sertã

Ref	€	Ø (cm)	Ød (cm)	h(cm)	U.Venta
27620	35,50	20	16,5	4,5	6
27624	40,60	24	20,0	5,2	6
27626	44,80	26	21,5	5,5	6
27628	48,40	28	24,0	6,0	6



## Grill

Grill · Grill Induktionfähig  
Grill · Grelhador

Ref	€	cm	Ød (cm)	h(cm)	U.Venta
27625	44,80	24x24	18,6	4,8	1
27629	51,90	28x28	21,5	5,2	1



# Titanium PRO Collection



- Cacerola robusta y duradera gracias a su cuerpo fabricado en aluminio fundido.
- Fabricada en una sola pieza.
- Libre de materiales pesados y tóxicos. ECO y libre de PFOA.
- Compatible con todas las fuentes de calor, incluida la inducción.
- Fácil limpieza interior y exterior.

- Casserole robuste et durable grâce à son corps fabriqué en fonte d'aluminium.
- Fabriquée en une seule pièce.
- Sans matériaux lourds et toxiques. ECO et sans PFOA.
- Compatible avec toutes les sources de chaleur, y compris l'induction.
- Nettoyage intérieur et extérieur facile.

- Robust and durable casserole thanks to its cast aluminium body.
- One piece construction.
- Free of heavy and toxic materials. ECO and PFOA-free.
- Compatible with all heat sources, including induction.
- Easy to clean interior and exterior.

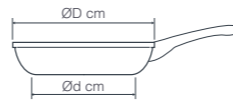

High release topcoat  
Partially reinforced midcoat  
Reinforced primer  
(titanium-based particles)  
Metal substrate

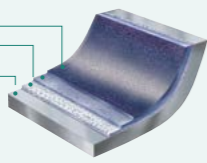

PPG QuanTanium™  
Titanium-reinforced non-stick coating

### Antiadherente QuanTanium® reforzado con partículas de titanio; libre de materiales tóxicos y pesados, ecológico y libre de PFOA

Antiadhésif QuanTanium® renforcé avec des particules de titane sans matériaux toxiques ni métaux lourds, écologique et sans PFOA.  
QuanTanium® non-stick reinforced with titanium particles; free from toxic and heavy materials, environmentally friendly and PFOA-free.



### Asas EXTRAÍBLES fabricadas en silicona de máxima calidad, termoaislantes, altamente resistentes y ergonómicas, permiten un agarre seguro. Mango con acabado SOFT TOUCH, termoaislante, altamente resistente y ergonómico, permite un agarre seguro.

Heat insulating, highly resistant, ergonomic REMOVABLE handles made of high quality silicone which provide a secure grip on pots and pans. Handle with SOFT TOUCH finish, heat insulating, highly resistant and ergonomic, allows a secure grip.

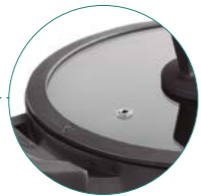

### Tapa de vidrio templado reforzada con un aro protector de silicona antipactos y una válvula de salida de vapor.

Tempered glass lid reinforced with an anti-shock silicone protective ring and a steam outlet valve.



### FULL INDUCTION; asegura un rendimiento óptimo en todo tipo de cocinas, con un reparto de calor inmejorable logrando la máxima eficiencia y ahorro de energía.

FULL INDUCTION diffuser base ensures optimum performance with all kinds of cookers. Its unbeatable heat distribution achieves the best efficiency and energy savings.

Incluye asas silicona  
Includes silicone handles



### Cacerola con tapa

Faitout avec couvercle · Bratentopf mit Deckel  
Casserole with lid · Çaçarola com tampa

Ref	€	Ø (cm)	h(cm)	e (mm)	L	U.Venta
27520	52,00	20	9,5	2,0	2,60	1
27524	62,90	24	11,0	2,0	4,40	1
27528	76,50	28	12,0	2,0	6,60	1

Incluye asas silicona  
Includes silicone handles



### Tartera con tapa

Plat rond avec couvercle · Pfanne mit Deckel  
Round dish with lid · Tarteira com tampa

Ref	€	Ø (cm)	h(cm)	e (mm)	L	U.Venta
27728	71,60	28	7,5	2,0	4,10	1
27732	85,90	32	8,0	2,0	5,70	1
27736	101,20	36	8,0	2,0	7,30	1



### Grill

Grill · Grill Induktionfähig  
Grill · Grelhador

Ref	€	cm	h(cm)	e (mm)	U.Venta
27827	54,90	28x28	4,0	1,8 mm	1

Aro protector de silicona  
Silicone protective ring



### Tapa

Couvercle en verre · Glasdeckel  
Glass lid · Tampa de vidro

Ref	€	Ø (cm)	U.Venta
27420	10,70	20	1
27424	12,40	24	1
27428	14,40	28	1
27432	16,30	32	1
27436	18,20	36	1



### Cazo

Casserole · Stielkasserolle, flach  
Saucepan · Çaçarola direite

Ref	€	Ø (cm)	h(cm)	e (mm)	L	U.Venta
27516	30,10	16	8,0	1,9	1,35	1



### Sartén

Poêle · Pfanne  
Frying-pan · Sertã

Ref	€	Ø (cm)	Ød (cm)	h(cm)	e (mm)	U.Venta
27820	31,50	20	16,6	5,0	1,9	6
27824	38,80	24	20,2	5,5	1,9	4
27828	47,10	28	23,4	6,0	1,9	6



### 4 in 1



### Sartén 4 cavidades

Poêle 4 cavités · Pfanne, 4-fache Einteilung  
Frying-pan 4 cavities · Sertã 4 cavidades

Ref	€	cm	h(cm)	e (mm)	U.Venta
27832	47,50	32x26	3,5	1,9	1

SI  
Silicone



### Asas

Poignées · Griffchutz, Silikon  
Handles · Asas

Ref	€	Ø (cm)	U.Venta
R27520A	4,40	20	1
R27528A	4,50	24-28	1
R27732A	5,60	32-36	1



## Fit Collection



- **Tratamiento electrolítico, el aluminio se sella completamente y se endurece para que no pase a los alimentos.**
- **Gran durabilidad y ultrarresistente: superficie robusta altamente resistente a roces, deformación y corrosión.**
- **Difunde el calor de forma uniforme evitando el sobrecalentamiento y obteniendo excelentes resultados de cocción.**
- **Mangos / Asas de acero inoxidable con remaches de aluminio que impiden la transferencia de calor.**
- **Tapas de vidrio templado reforzadas en el borde con acero inoxidable.**
- **Compatible con todas las fuentes de calor, incluida la inducción.**

- **Traitement électrolytique, l'aluminium est totalement scellé et durcit pour ne pas pouvoir atteindre les aliments.**
- **Grande durabilité et ultra résistante : Surface robuste hautement résistante aux rayures, à la déformation et à la corrosion.**
- **Diffuse la chaleur de façon uniforme, évitant ainsi la surchauffe et obtenant d'excellents résultats de cuisson.**
- **Anses et poignées en acier inoxydable avec des rivets en aluminium qui empêchent le transfert de chaleur.**
- **Couvercles en verre trempé renforcés avec le bord en acier inoxydable.**
- **Compatible avec toutes les sources de chaleur, y compris l'induction.**

- **Electrolytic treatment, the aluminium is completely sealed and hardened so no metal is passed on to the food.**
- **Extremely durable and ultra-high strength: It has a robust surface that is highly resistant to abrasion, warping and corrosion.**
- **It distributes heat evenly to avoid overheating and provide excellent cooking results.**
- **Stainless steel handles with aluminium rivets that avoid heat transfer.**
- **The lid is tempered glass with stainless steel reinforcement around the edge.**
- **Compatible with all heat sources, including induction.**

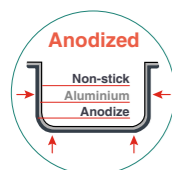

**Anodized**  
Capa de óxido natural de protección muy gruesa.  
Couche d'oxydation naturelle de protection très épaisse.  
Thick natural oxide protective layer.



**Abrasion**  
Muy resistentes a arañazos, deformaciones y corrosión.  
Très résistante aux rayures, à la déformation et à la corrosion.  
Very resistant to scratches, deformation and corrosion.

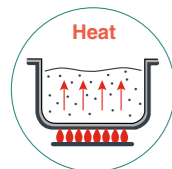

**Heat**  
Distribuye uniformemente el calor, sin áreas de sobrecalentamientos.  
Distribue uniformément la chaleur, sans zones de surchauffe.  
Hot spot free, uniform heat distribution.

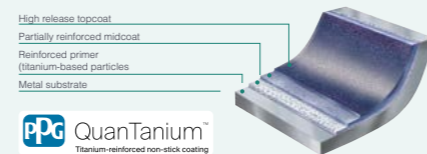
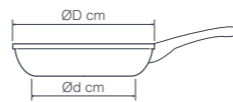

**Antiadherente QuanTanium® reforzado con partículas de titanio; libre de materiales tóxicos y pesados, ecológico y libre de PFOA**  
Antiadhésif QuanTanium® renforcé avec des particules de titane sans matériaux toxiques ni métaux lourds, écologique et sans PFOA.  
QuanTanium® non-stick reinforced with titanium particles; free from toxic and heavy materials, environmentally friendly and PFOA-free.



**Cacerola con tapa**  
Faitout avec couvercle · Bratentopf mit Deckel  
Casserole with lid · Caçarola com tampa

Ref	€	Ø (cm)	h(cm)	e (mm)	L	U.Venta
48016	43,80	16	8,0	4,5	1,50	1
48020	53,10	20	9,0	4,5	2,60	1
48024	65,20	24	10,0	4,5	4,20	1
48028	76,60	28	11,0	4,5	6,30	1



**Olla con tapa**  
Marmite avec couvercle · Fleichtopf mit Deckel  
Stock pot with lid · Panela com tampa

Ref	€	Ø (cm)	h(cm)	e (mm)	L	U.Venta
48116	50,40	16	13,0	4,5	2,50	1
48120	59,70	20	14,0	4,5	4,20	1
48124	75,00	24	15,0	4,5	6,50	1
48128	89,60	28	17,0	4,5	10,00	1



**Cazo**  
Casserole · Stielkasserolle, flach  
Saucepan · Caçarola direite

Ref	€	Ø (cm)	h(cm)	e (mm)	L	U.Venta
48214	30,40	14	7,5	4,5	1,00	1
48216	33,90	16	8,0	4,5	1,50	1
48218	38,10	18	9,0	4,5	2,10	1
48220	43,10	20	10,0	4,5	2,90	1



**Tartera con tapa**  
Plat rond avec couvercle · Pfanne mit Deckel  
Round dish with lid · Tarteira com tampa

Ref	€	Ø (cm)	h(cm)	e (mm)	L	U.Venta
48624	58,90	24	7,0	4,5	2,90	1
48628	70,40	28	8,0	4,5	4,50	1

**Aro protector de acero inoxidable**  
Stainless steel protective ring

**Vidrio templado**  
Tempered glass

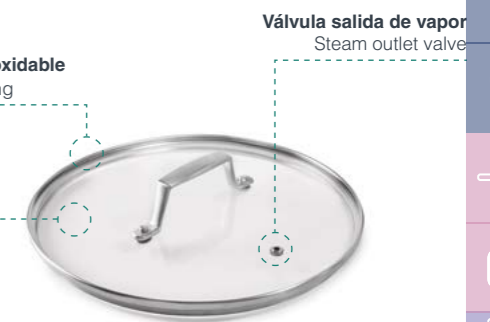

CRISTAL Glass INOX Dishwasher

**Tapa**  
Couvercle · Deckel  
Lid · Tampa

Ref	€	Ø (cm)	U.Venta
48916	12,30	16	1
48920	13,90	20	1
48924	15,30	24	1
48928	17,00	28	1



**Sartén**  
Poêle · Pfanne  
Frying pan · Sertã

Ref	€	Ø (cm)	Ød (cm)	h(cm)	e (mm)	U.Venta
48720	33,20	20	15,0	4,0	4,5	6
48724	41,50	24	18,0	4,5	4,5	6
48728	49,50	28	22,0	5,0	4,5	6



# Cocottes Collection



- Fabricada en aluminio fundido. Diseño atractivo y funcional.
- Garantiza la absorción y distribución uniforme del calor, sin puntos de sobrecalentamiento.
- La distribución del calor uniforme por toda la pieza hace que los alimentos no pierdan su jugo durante la cocción, conservando así todos sus nutrientes y vitaminas.
- Las puntas situadas bajo la tapa, hacen que las gotas fruto de la condensación, vuelvan a caer sobre los alimentos formando un lujo circulante y permanente reduciendo la pérdida de sabores y jugos de los alimentos.
- Es la pieza perfecta para: arroces, carnes, pescados, legumbres, verduras, guisos, cremas, salsas, sopas, etc.
- Revestimiento antiadherente ILAG:ULTIMATE.

- Fabriqué en aluminium fondu. Conception attrayante et fonctionnelle.
- Il garantit l'absorption et la distribution uniformes de la chaleur, sans surchauffe.
- La distribution de la chaleur uniforme dans toute la pièce fait que les aliments ne perdent pas leur jus pendant la cuisson, conservant ainsi tous ses nutriments et vitamines.
- Les conseils sous le couvercle, font les gouttes résultant de la condensation, tombent à nouveau dans des aliments formant un luxe en circulation et permanent réduisant la perte de saveurs et de jus de nourriture.
- C'est la pièce parfaite pour: le riz, les viandes, le poisson, les légumineuses, les légumes, les ragoûts, les crèmes, les sauces, les soupes, etc.
- Ilag: Ultime.

- Manufactured in molten aluminum. Attractive and functional design.
- It guarantees the uniform absorption and distribution of heat, without overheating points.
- The distribution of uniform heat throughout the piece causes food not to lose their juice during cooking, thus retaining all its nutrients and vitamins.
- The tips under the lid, make the drops resulting from condensation, fall again on food forming a circulating and permanent luxury reducing the loss of flavors and food juices.
- It is the perfect piece for: rice, meats, fish, legumes, vegetables, stews, creams, sauces, soups, etc.
- Ilag: Ultimate.



## Cacerola con tapa Mini

Faitout avec couvercle "MINI" · "MINI" Bratentopf mit Deckel  
"MINI" round casserole with lid · Caçarola com tampa "MINI"

	Ref	€	Ø (cm)	h(cm)	L	U.Venta
A	25909	23,10	10	5,0	0,24	12
	25914	33,90	14	7,5	0,90	1
B	25910	23,10	10	5,0	0,24	1
	25915	33,90	14	7,5	0,90	1

## Cacerola oval con tapa Mini

Faitout Ovale avec couvercle "MINI" · "MINI" Oval Bratentopf mit Deckel  
"MINI" oval round casserole with lid · Caçarola oval com tampa "MINI"

	Ref	€	Ø (cm)	h(cm)	L	U.Venta
A	25911	24,30	12x8,5	5,0	0,25	1
B	25912	23,00	12x8,5	5,0	0,25	1



## Cacerola con tapa

Faitout avec couvercle · Bratentopf mit Deckel  
Round casserole with lid · Caçarola com tampa

	Ref	€	Ø (cm)	h(cm)	L	U.Venta
	25916	49,90	16	7,0	1,30	1
A	25920	65,00	20	8,0	2,40	1
	25924	83,90	24	10,0	4,20	1
	25928	107,00	28	11,5	6,70	1
B	25917	55,50	16	7,0	1,30	1
	25921	73,20	20	8,0	2,40	1
	25925	91,50	24	10,0	4,20	1
	25929	112,00	28	11,5	6,70	1



## Cacerola oval con tapa

Faitout Ovale avec couvercle · Oval Bratentopf mit Deckel  
Oval round casserole with lid · Caçarola oval com tampa

	Ref	€	cm	h(cm)	L	U.Venta
	25927	77,40	26x20	9,0	3,50	1
A	25931	106,20	31x25	11,0	6,30	1
B	25933	83,50	26x20	9,0	3,50	1
	25935	115,10	31x25	11,0	6,30	1



Protección total  
Full protection

## Cazo

Casserole · Stielkasserole, flach  
Saucepan · Caçarola direite

	Ref	€	Ø (cm)	Ød (cm)	h(cm)	e (mm)	L	U.Venta
	25956	30,50	16	12,0	8,0	1,6	1,30	1
	25958	34,20	18	15,0	8,5	1,6	1,80	1
	25950	37,50	20	16,5	9,0	1,6	2,40	1

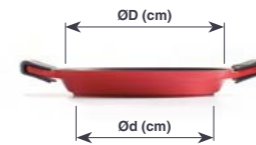

Incluye asas de silicona  
Includes silicone handles



## Paellera

Plat rond · Pfanne  
Round · Paelheira

	Ref	€	Ø (cm)	Ød (cm)	h(cm)	e (mm)	Raciones	U.Venta
	25932	84,30	32	25,5	4,5	1,6	5	1
	25936	98,50	36	29,5	4,5	2,0	7	1
	25940	109,50	40	33,5	4,5	2,0	9	1

## Manoplas de silicona

Mouffettes en silicone · Griffchutuz aus Silikon  
Silicone mittens · Pegas de silicone

	Ref	€	Ø (cm)	U.Venta
	R25917G	8,40	16	6
	R25933G	8,40	20-24-28-26x20	6
	R25935G	8,00	31x25	6

- Fabricada en aluminio fundido.
- Garantiza la absorción y distribución uniforme del calor, sin puntos de sobrecalentamiento.
- La distribución del calor uniforme por toda la pieza hace que los alimentos no pierdan su jugo durante la cocción, conservando así todos sus nutrientes y vitaminas.
- Fondo difusor FULL INDUCTION; asegura un rendimiento óptimo en todo tipo de cocinas con un reparto de calor inmejorable logrando la máxima eficiencia y ahorro de energía.
- Perfecta para arroces, carnes, pescados, legumbres, verduras, guisos, cremas, salsas, sopas, etc.
- Revestimiento antiadherente Xylan Plus.
- Diseño atractivo y funcional.
- Compatible con todo tipo de cocinas, incluida la inducción.
- Manufactured in molten aluminum.
- It guarantees the uniform absorption and distribution of heat, without overheating points.
- The distribution of uniform heat throughout the piece causes food not to lose their juice during cooking, thus retaining all its nutrients and vitamins.
- Full Induction Diffuser Fund; ensures optimal performance in all types of kitchens with an unbeatable heat distribution achieving maximum efficiency and energy saving.
- Perfect for rice, meats, fish, legumes, vegetables, stews, creams, sauces, soups, etc.
- Antiating Coating Xylan Plus.
- Attractive and functional design.
- Compatible with all types of kitchens, including induction.





## Mini Collection



- Fabricadas en aluminio fundido de máxima calidad.
- Ideal tanto para cocinar como para presentar aperitivos o platos.
- Antiadherente bicapa de alta calidad y 100% libre de PFOA.
- Libres de materiales tóxicos, pesados, disolventes y sustancias químicas.
- Diseñadas para una cocina saludable: permite cocinar sin apenas aceite garantizando que los alimentos no se peguen.
- Distribución homogénea del calor que permite una cocción rápida y uniforme.
- Aptas para todo tipo de fuegos: gas, eléctrica, vitrocerámica e inducción.
- Tapa fabricada en vidrio templado con válvula desalida de vapor.
- Pomo baquelita con acabado Soft Touch.
- Mango ergonómico con acabado Soft Touch.

- Fabriqué en fonte d'aluminium de la plus grande qualité.
- Idéale aussi bien pour cuisiner que pour la d'apéritifs ou de plats.
- Finition antiadhésive bi-couche de grande qualité et 100% sans PFOA.
- Sans matériaux toxiques, métaux lourds, dissolvants et substances chimiques.
- Conçue pour une cuisine saine : permet de cuisiner sans à peine utiliser d'huile et avec la garantie que les aliments ne collent pas.
- Distribution homogène de la chaleur, ce qui permet une cuisson rapide et uniforme.
- Apte pour tous types de feux : gaz, électricité, vitroceramique, four et induction.
- Couvercle fabriqué en verre trempé avec valve à vapeur.
- Poignée en bakélite avec finition Soft Touch.
- Manche ergonomique avec finition Soft Touch.

- Made from a single piece of top quality cast aluminium.
- It's perfect for both cooking and presenting appetisers or dishes.
- It has a high quality bi-layer non-stick coating that is 100% PFOA free.
- It's free of toxic materials, heavy metals, solvents and chemical substances.
- It's designed for healthy cooking. It lets you cook with practically no oil and be sure that food won't stick.
- Food is cooked quickly and evenly because of the homogeneous heat distribution.
- It's suitable for all kinds of cookers: gas, electric, vitroceramic, oven and induction.
- The lid is made of tempered glass with a steam valve.
- Bakelite handle with a Soft Touch finish.
- Ergonomic handle with a Soft Touch finish.

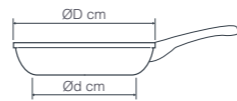

### Cacerola con tapa

Faitout avec couvercle · Bratentopf mit Deckel  
Casserole with lid · Caçarola com tampa

Ref	€	Ø (cm)	Ød (cm)	h(cm)	L	U.Venta
25160	21,50	16	12	5,0	0,8	1



### Cazo

Casserole · Stielkasserole, flach  
Saucepan · Caçarola direite

Ref	€	Ø (cm)	Ød (cm)	h(cm)	L	U.Venta
25164	16,60	14	10	8,0	1,0	1



### Paellera

Plat à paella · Pfanne  
Round dish · Paelheira

Ref	€	Ø (cm)	Ød (cm)	h(cm)	L	U.Venta
25161	21,50	20	11,5	4,5	1,0	1



### Sartén

Poêle · Pfanne  
Frying pan · Sertä

Ref	€	Ø (cm)	Ød (cm)	h(cm)	U.Venta
25163	13,20	14	10,0	3,0	1



### Grill

Grill · Grill Induktionfähig  
Grill · Grelhador

Ref	€	cm	Ød (cm)	h(cm)	U.Venta
25162	14,50	14x14	10,0	2,5	1



## Smart Collection



- Cacerola y paellera de hierro muy resistentes.
- Cubiertas con una capa de esmalte vitricado antiácido de máxima calidad.
- Asas altamente reforzadas.
- Perfectas para presentar y servir sabrosas tapas, raciones o pinchos.

- Faitout et poêle à paella en fer très résistantes.
- Possèdes un revêtement avec une couche d'acier émaillé de la plus grande qualité.
- Anses hautement renforcées.
- Parfaites pour présenter et servir de savoureuses tapas, de petites portions ou des amuse-bouches.

- Extremely strong metal casserole and paella dish.
- Coated with a layer of top quality antacid vitrified enamel.
- Heavily reinforced handles.
- Perfect for serving or presenting delicious tapas, dishes or pinchos.



### Cacerola

Faitout à paella · Bratentopf, emailiert  
Casserole · Caçarola esmaltada

Ref	€	Ø (cm)	h(cm)	U.Venta
60192	6,70	12	4,0	1
60196	7,90	16	4,5	1
60190	8,70	20	4,7	1



### Paellera

Plat à paella · Paellapfanne, emailiert  
Round dish for paelle · Paelheira esmaltada

Ref	€	Ø (cm)	U.Venta
60170	5,20	10	1
60172	5,90	12	1
60175	6,90	15	1
60180	8,80	20	1

# Magma Collection



- Construida en una sola pieza.
- Recubierta con una capa de aceite vegetal.
- Ideal para cocinar, prolonga suavemente la cocción.
- Gran conductor del calor, mantiene el calor mientras disfrutas y saboreas la comida.
- Base de madera para servir y presentar la comida recién cocinada.

- Construit en un seul morceau.
- Recouvert d'une couche d'huile végétale.
- Idéal pour la cuisine, la cuisine doucement prolongée.
- Excellent conducteur de chaleur, gardez la chaleur tout en profitant et sauvant la nourriture.
- Base de bois pour servir et présenter des aliments fraîchement cuits.

- Built in one piece.
- Covered with a layer of vegetable oil.
- Ideal for cooking, gently prolonged cooking.
- Great heat driver, keep heat while enjoying and savors the food.
- Wood base to serve and present freshly cooked food.



## Cacerola

Faitout · Bratentopf  
Casserola · Caçarola

Ref	€	Ø (cm)	ml	U.Venta
25771	11,00	12,5	230	4
25772	16,00	16,2	470	4
25773	19,30	18,5	720	1



## Cacerola con base

Faitout avec basse · Bratentopf mit Holzsockel  
Casserola with base · Caçarola com base

Ref	€	Ø (cm)	ml	U.Venta
25871	15,80	12,5	230	4
25872	21,60	16,2	470	1
25873	27,70	18,5	720	1



## Cacerola oval

Faitout ovale · Oval Bratentopf  
Oval casserola · Caçarola oval

Ref	€	cm	ml	U.Venta
25781	12,40	15x10	200	4
25782	19,50	17,5x12,5	300	1
25783	22,20	21,7x15	700	1



## Cacerola oval con base

Faitout ovale avec basse · Oval Bratentopf mit Holzsockel  
Oval casserola with base · Caçarola oval com base

Ref	€	cm	ml	U.Venta
25881	16,00	15x10	200	4
25882	24,70	17,5x12,5	300	1
25883	27,40	21,7x15	700	1



## Mini plancha rectangular

Mini plaque grill lisse rectangulaire · Mini Platte Grill, glatt, rechteckiger  
Mini rectangular grill plaque flat · Mini plancha grill liso rectangular

Ref	€	cm	U.Venta
25774	10,50	17x10	4



## Mini plancha rectangular con base

Mini plaque Grill lisse rectang. a/basse · Mini Platte Grill, glatt, rechteckiger m/Holzsockel  
Mini rectangular grill plaque flat with base · Mini plancha grill liso rectangular c/base

Ref	€	cm	h(cm)	U.Venta
25874	15,40	17x10	2,5	4



## Mini plancha grill cuadrado

Mini plaque grill carré · Mini Platte Grill, Quadrat  
Mini square grill plaque · Mini plancha grill quadrado

Ref	€	cm	h(cm)	U.Venta
25775	11,00	14x14	1,7	4



## Mini grill

Mini grill · Mini Grill  
Mini grill · Mini grill

Ref	€	cm	h(cm)	U.Venta
25776	11,40	14x14	2,5	4



## Mini sartén lisa

Mini poêle lisse · Mini Pflanne  
Mini frying pan flat · Mini sertã lisa

Ref	€	Ø (cm)	h(cm)	U.Venta
25777	11,50	13	1,7	4



## Mini plancha grill cuadrado con base

Mini plaque grill carré avec basse · Mini Platte Grill, Quadrat mit Holzsockel  
Mini square grill plaque with base · Mini plancha grill quadrado com base

Ref	€	cm	h(cm)	U.Venta
25875	15,40	14x14	1,7	4



## Mini grill con base

Mini grill avec basse · Mini Grill mit Holzsockel  
Mini grill with base · Mini grill com base

Ref	€	cm	h(cm)	U.Venta
25876	17,80	14x14	2,5	1



## Mini sartén lisa con base

Mini poêle lisse avec basse · Mini Pflanne mit Holzsockel  
Mini frying pan flat with base · Mini sertã lisa com base

Ref	€	Ø (cm)	h(cm)	U.Venta
25877	16,50	13	1,7	1

Mango desmontable  
Removable handle



## Bandeja oval con mango y base MAGMA

Plateau ovale avec manche et base · Ovale tablett mit griff und basis  
Oval tray with handle and base · Bandeja oval com cabo e base

Ref	€	cm	h (cm)	U.Venta
25867	18,10	24x14	2,2	1

- Bandeja oval con mango desmontable fabricada en hierro fundido de gran calidad.
- Recubierta con una capa de aceite vegetal.
- Base de madera natural, diseñada para servir y presentar la comida recién cocinada.
- Versátil: Diseñado para cocinar todo tipo de alimentos tanto en cocinas interiores (inducción, vitro, gas, horno) como en exteriores (parrillas, barbacoas, planchas)
- Se calientan rápidamente, transmiten y conservan muy bien el calor y aguantan altas temperaturas.

- Plateau ovale avec manche démontable fabriqué en fonte de grande qualité.
- Recouvert d'une couche d'huile végétale.
- Base en bois naturel ; conçu pour servir et présenter la nourriture fraîchement préparée.
- Versatile : conçu pour cuire tout type d'aliments sur des sources de chaleur aussi bien à l'intérieur (induction, vitrocéramique, gaz, four) qu'à l'extérieur (grills, barbecues, planchas).
- Chauffe rapidement, transmet et conserve très bien la chaleur et résiste à de hautes températures.

- Oval tray with detachable handle made of high quality cast iron.
- Coated with a layer of vegetable oil.
- Natural wood base, designed for serving and presenting freshly cooked food.
- Fully versatile: designed for cooking all types of food, both indoors (induction, vitro, gas, oven) and outdoors (grills, barbecues, griddles).
- They heat up quickly, transmit and retain heat very well and withstand high temperatures.



## Magma Grey & Red



- Acabado exterior e interior esmaltado, muy resistente y de gran durabilidad.
- Muy versátil: ideal para cocinar asados, arroces, pasta, cocer a fuego lento e incluso hornear tartas dulces y pan.
- Conserva todos los nutrientes, vitaminas y sabores de los alimentos.
- Excelente retención y distribución uniforme del calor.
- Incluye base de madera, ideal para servir y presentar.

- Apta para todo tipo de fuegos. Finition émaillée extérieure et intérieure, très résistante et d'une grande durabilité.
- Très polyvalent: idéal pour cuisiner des rôtis, du riz, des pâtes, cuire à feu doux et même cuire des gâteaux sucrés et à pain.
- Gardez tous les nutriments, vitamines et saveurs des aliments.
- Excellente rétention et distribution uniforme de la chaleur.
- Comprend la base en bois, idéale pour servir et présenter.

- Convient à tous les types d'incendies. Exterior and interior enameled finish, very resistant and of great durability.
- Very versatile: Ideal for cooking roasts, rice, pasta, cook over low heat and even bake sweet and bread cakes.
- Keep all nutrients, vitamins and flavors of food.
- Excellent retention and uniform distribution of heat.
- Includes wood base, ideal to serve and present.
- Suitable for all types of fires.



### Cacerola redonda

Faitout rond · Rund Bratentopf  
Round casserole · Caçarola redonda

	Ref	€	Ø (cm)	h(cm)	ml	U.Venta
A	25841	18,10	12,0	3,0	200	1
	25848	28,10	16,2	3,0	470	1
	25849	34,80	18,5	3,0	720	1
B	25851	18,10	12,0	3,0	200	1
	25858	28,10	16,2	3,0	470	1
	25859	34,80	18,5	3,0	720	1

### Cacerola oval

Faitout ovale · Oval Bratentopf  
Oval casserole · Caçarola oval

	Ref	€	cm	h(cm)	ml	U.Venta
A	25842	24,10	17,5x12,5	3,0	250	1
	25840	34,70	21,7x15	3,0	700	1
B	25852	24,30	17,5x12,5	3,0	250	1
	25850	35,00	21,7x15	3,0	700	1



### Sartén

Poêle · Pfanne  
Frying pan · Sertä

	Ref	€	Ø (cm)	h(cm)	ml	U.Venta
A	25843	18,20	13,5	3,0	275	1
B	25853	18,20	13,5	3,0	275	1



### Cacerola redonda con tapa

Faitout rond avec couvercle · Rund Bratentopf mit Deckel  
Round casserole with lid · Caçarola redonda com tampa

	Ref	€	Ø (cm)	h(cm)	ml	U.Venta
A	25846	29,30	10	5,0	200	1
B	25856	29,30	10	5,0	200	1



### Cacerola oval con tapa

Faitout ovale avec couvercle · Oval Bratentopf mit Deckel  
Oval casserole with lid · Caçarola oval com tampa

	Ref	€	cm	h(cm)	ml	U.Venta
A	25847	34,70	13x10	5,0	400	1
B	25857	34,70	13x10	5,0	400	1



# Ollas a presión

## Pressure cookers



Sistema de apertura y cierre con una sola mano  
Opening and closing system with one hand

## Chef luxe

INOX 18/10



- Sistema de apertura y cierre con una sola mano.
- Selección de posiciones (3 posiciones: 0 - I - II).
- Se puede utilizar como una cacerola normal.

- Ouverture et de fermeture d'une seule main.
- Sélection positions(3 positions: 0 - I - II).
- Peut être utilisé comme une casserole normale.

- Opening and closing system with one hand.
- Selecting positions (3 position: 0 - I - II).
- Can be used as a normal casserole.



### Olla a presión

Cocotte à pression · Schnellkochtopf  
Pressure cooker · Panela de pressão

Ref	€	Ø (cm)	h(cm)	L	U.Venta
50815	606,90	32	18,0	15,0	1
50818	624,60	32	23,0	20,0	1
50823	656,10	32	32,0	23,0	1



### Cuerpo

Corps cocotte à pression · Schnellkochtopf-Körper  
Pressure cooker stockpot · Corpo panela de pressão

Ref	€	Ø (cm)	h(cm)	L	U.Venta
50816	209,50	32	18,0	15,0	1
50819	227,10	32	23,0	20,0	1
50824	258,70	32	32,0	23,0	1

A



B



### Tapa

Couvercle · Deckel  
Lid · Tampa

Ref	€	Ø (cm)	U.Venta
A 50934	397,50	32	1
B 54932	28,60	32	1

# Robust

AL FUNDIDO  
Aluminium Cast

Vitro Electric Gas Oven Dishwasher

- Diseñada para uso profesional.
- Fabricada en aluminio de máxima calidad (grado de pureza 99,55%).
- Especialmente indicada para cocinas de gas, eléctricas y vitrocerámicas.
- Excelente conductor térmico. Rápida y eficiente. Posee un elevado rendimiento energético (70%).
- Triple sistema de seguridad.
- Puente más robusto y resistente.
- Asas de baquelita antiquemaduras.

- Conçue pour un usage professionnel.
- Il est conçu en aluminium haute qualité (degré de pureté de 99,5 %).
- Adaptée aux gaz, cuisinières électriques et plaques de cuisson.
- Excellent conducteur thermique. Rapide et efficace. Confère un rendement énergétique élevé (70%).
- Triple système de sécurité.
- Pont plus robuste et résistant.

- Poignées en bakélite anti-brûlures.
- For Professional use.
- Made of high quality aluminium (with a 99.5% degree of purity).
- Suitable for gas, electric, cookers and cooktops.
- Excellent thermal conductivity. Fast and efficient. High energy performance (70%).
- Triple safety system.
- Stronger and more robust bridge.
- Anti-scald bakelite handles.



1 Triple sistema de seguridad  
2 Triple safety system  
3

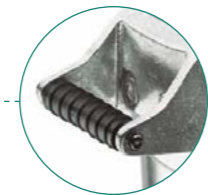

Asas de baquelita antiquemaduras  
Anti-scald bakelite handles



## Olla a presión

Cocotte à pression · Schnellkochtopf  
Pressure cooker · Panela de pressão

Ref	€	Ø (cm)	h(cm)	L	U.Venta
20830	1394,90	42	31	30	1
20840	1487,50	42	39	40	1
20850	1580,30	42	46	50	1

# Pro Classic

AL INOX  
Aluminium Vitro Electric Gas Oven Dishwasher

- Diseñada para uso profesional.
- Fabricada en aluminio.
- Especialmente indicada para cocinas de gas, eléctricas y vitrocerámicas.
- Excelente conductor térmico. Rápida y eficiente. Posee un elevado rendimiento energético (70%).
- Válvula de presión/contrapeso: permite que se libere el vapor regulando la presión interior de la olla. Válvula de seguridad/despresurización: actúa en caso en el que falle la válvula de presión.
- Puente más robusto y resistente.
- Asas de baquelita antiquemaduras.

- Conçue pour un usage professionnel.
- Fabriquée en aluminium.
- Adaptée aux gaz, cuisinières électriques et plaques de cuisson.
- Excellent conducteur thermique. Rapide et efficace. Confère un rendement énergétique élevé (70%).
- Soupape à pression/contrepois : permet de libérer la vapeur en régulant la pression intérieure de l'autocuiseur.
- Soupape de sécurité/dépressurisation : agit dans le cas d'un dysfonctionnement de la soupape à pression.
- Pont plus robuste et résistant.
- Poignées en bakélite anti-brûlures.

- For Professional use.
- Made of aluminium.
- Suitable for gas, electric, cookers and cooktops.
- Excellent thermal conductivity. Fast and efficient. High energy performance (70%).
- The pressure/counterweight valve lets steam escape and regulates pressure inside the pot.
- Safety/depressurisation valve: acts in case of failure of the pressure valve.
- Stronger and more robust bridge.
- Anti-scald bakelite handles.



## Olla a presión

Cocotte à pression · Schnellkochtopf  
Pressure cooker · Panela de pressão

Ref	€	Ø (cm)	h(cm)	L	U.Venta
20511	114,60	28	22	11,0	1
20515	131,70	30	25	15,0	1
20518	163,90	32	23	18,0	1
20522	182,10	34	23	22,0	1
20533	217,70	36	32,0	33,0	1
20540	236,10	40	32,5	40,0	1
20550	282,00	44	34,0	50,0	1

	Válvula de seguridad Safety valve	Válvula de cocción Cooking valve
A	1	1
B	1	2
C	2	2

# Classic



- Fabricada en acero inoxidable 18/10 de máxima calidad.
- Marcaje interior, grabado con la capacidad del uso de la olla.
- Asas de baquelita antiquemaduras. Válvula de seguridad.
- Apta para todo tipo de cocinas. Triple fondo FULL INDUCTION para una distribución rápida y homogénea del calor.
- Las referencias 71872-71875 contienen un cestillo.

- Fabrication en acier inoxydable 18/10 de qualité maximale.
- Marquage intérieur, marquage gravé de la capacité d'utilisation de l'autocuiseur.
- Poignées en bakélite anti-brûlures. Soupape de sécurité.
- Apte pour tout type de feux. Triple fond FULL INDUCTION pour une distribution rapide et homogène de la chaleur.
- \* Les références 71872-71875 contiennent un panier.

- Manufactured in high-quality 18/10 stainless steel.
- Inner marking, engraved with the cooker's capacity.
- Burn-resistant Bakelite handles Safety valve.
- Suitable for any type of hob. Tri-ply FULL INDUCTION base for quick, even heat distribution.
- \* The 71872-71875 references contain a basket.

Válvula de seguridad  
Safety valve



Marcajes de capacidad en litros  
Capacity markings inside in litres



Asas de baquelita antiquemaduras  
Anti-scald bakelite handles



Triple fondo difusor  
Triple diffuser bottom



## Olla a presión

Cocotte à pression · Schnellkochtopf  
Pressure cooker · Panela de pressão

Ref	€	Ø (cm)	h(cm)	e (mm)	L	U.Venta
71874	89,00	22	11,5	1,2	4,0	1
71876	97,60	22	17,0	1,2	6,0	1
71878	106,70	24	19,0	1,2	8,0	1
71871	116,30	24	23,0	1,2	10,0	1
71872	183,50	26	23,0	1,2	12,0	1
71875	197,50	26	29,0	1,2	15,0	1



garinox®

# Genius



- Fabricada: acero inoxidable 18/10 de máxima calidad. Acabado pulido espejo exterior.
- Marcaje interior: Grabado con la capacidad del uso de la olla.
- Cierre fácil y seguro: Gracias a su asa ergonómica, es fácil y cómodo de abrir.
- Triple fondo difusor: Garantiza una óptima difusión del calor, favoreciendo un importante ahorro de energía (70%) y una cocción uniforme resaltando el aroma y sabor de los alimentos.
- Sistema de seguridad: Válvula de seguridad, actúa en caso de aumento excesivo de presión, despresurizando rápidamente la olla.
- Apta para todo tipo de cocinas y el lavavajillas.

- Fabrication : En acier inoxydable 18/10 de qualité maximale. Finition polissage miroir extérieur.
- Marquage intérieur : Marquage gravé de la capacité d'utilisation de l'autocuiseur.
- Fermeture facile et sûre : Grâce à son manche ergonomique, permet une ouverture simple et pratique.
- Triple fonds diffuseur : Garantit une diffusion optimale de la chaleur, favorisant ainsi d'importantes économies d'énergie (70%) et une cuisson uniforme accentuant l'odeur et le goût des aliments.
- Système de sécurité : Soupape de sécurité, agit en cas d'augmentation excessive de la pression, dépressurisant rapidement
- Apte pour tout type de cuisinières et le lave-vaisselle.

- Manufactured: High-quality 18/10 stainless steel. Exterior mirror-polished finish.
- Inner marking: Engraved with the cooker's capacity.
- Easy, safe closing: Thanks to its ergonomic handle, it's easy and convenient to open.
- Triple diffuser base: Ensures optimum heat diffusion, enabling a significant energy saving (70%) and even cooking that enhances the aroma and flavour of the food.
- Safety system: The safety valve operates in the case of an excessive increase in pressure, quickly releasing pressure from the cooker.
- Suitable for all types of cookers and dishwashers.

## Olla a presión

Cocotte à pression · Schnellkochtopf  
Pressure cooker · Panela de pressão

Ref	€	Ø (cm)	h(cm)	L	U.Venta
71904	61,20	22	11,5	4,0	1
71906	67,50	22	17,0	6,0	1
71908	76,10	24	19,0	8,0	1
71901	84,30	24	23,0	10,0	1





**Sistema de apertura y cierre con una sola mano**  
One-handed opening and closing mechanism

**Nivel de cocción: 0 y 100kpa**  
Cooking level

**Fondo termodifusor**  
Thermo-diffuser bottom



## Sicuro



- Fabricada en acero inoxidable 18/10 de máxima calidad con acabado satinado.
- Fondo termodifusor sándwich; distribución rápida y uniforme del calor.
- Marcaje interior en litros.
- Asas termostables que aseguran un manejo cómodo y seguro.
- Ahorra un 70% de energía conservando el aroma y sabor de los alimentos.
- Nivel de cocción totalmente ajustable: gira el pomo y elige la presión entre 0 y 100kpa.
- Cierre fácil y 100% seguro: sistema de apertura y cierre con una sola mano.
- Triple sistema de seguridad: 1) Válvula de seguridad: actúa en caso de aumento excesivo de presión, despresurizando rápidamente la olla. 2) Sistema de bloqueo de seguridad: imposibilidad de apertura de la tapa mientras cocinamos. 3) Ventana lateral de seguridad.
- Compatible con todas las fuentes de calor, incluida la inducción. Cuerpo apto para el lavavajillas.

- Fabriqué en acier inoxydable 18/10 de qualité maximale avec finition en satin.
- Fond de thermodifusor sandwich; Distribution rapide et uniforme de la chaleur.
- Marquage intérieur en litres.
- Poignées résistantes aux thermorales qui garantissent une manipulation confortable et sûre.
- Économisez 70% d'énergie préservant l'arôme et le goût des aliments.
- Niveau de cuisson entièrement réglable: Tournez le bouton et choisissez la pression entre 0 et 100 kpa.
- Close d'assurance facile et 100%: système d'ouverture et de clôture d'une seule main.
- Système de sécurité triple: 1) Vanne de sécurité: agit en cas d'augmentation excessive de pression, décompressant rapidement le pot. 2) Système de blocage de sécurité: impossibilité d'ouvrir le couvercle pendant que nous cuisinons. 3) Fenêtre latérale de sécurité.
- Compatible avec toutes les sources de chaleur, y compris l'induction.

- Corps adapté au lave-vaisselle. Made of stainless steel 18/10 of maximum quality with satin finish.
- Sandwich thermodifusor background; Quick and uniform distribution of heat.
- Interior marking in liters.
- Thermor resistant handles that ensure comfortable and safe handling.
- Save 70% energy preserving the aroma and taste of food.
- Fully adjustable cooking level: Turn the knob and choose the pressure between 0 and 100kpa.
- Easy and 100% Insurance closure: Opening and closing system with one hand.
- Triple Security System: 1) Safety valve: Acts in case of excessive pressure increase, rapidly discouraging the pot. 2) Safety blocking system: Impossibility of opening the lid while we cook. 3) Security side window.
- Compatible with all heat sources, including induction. Body suitable for dishwasher.



### Olla a presión

Cocotte à pression · Schnellkochtopf  
Pressure cooker · Painela de pressão

Ref	€	Ø (cm)	h(cm)	L	U.Venta
71784	204,60	22	11,0	4,0	1
71786	210,70	22	16,0	6,0	1
71788	221,50	22	21,1	8,0	1



## Master



- Fabricada en acero inoxidable 18/10 de máxima calidad.
- Marcaje interior, grabado con la capacidad del uso de la olla.
- Visualizador de los niveles de cocción mediante anillos de colores.
- 2 niveles de cocción: 1- Rápida (verduras, hortalizas y pescados). / 2- Superrápida (carnes y estofados).
- Válv. de seguridad · Sist. de bloqueo de seguridad · Ventanas laterales de seguridad.
- Apta para todo tipo de cocinas.
- Fondo FULL INDUCTION.

- Fabrication en acier inoxydable 18/10 de qualité maximale.
- Marquage intérieur, marquage gravé de la capacité d'utilisation de l'autocuiseur. Visualisateur des niveaux de cuisson via anneaux de couleur.
- 2 niveaux de cuisson: 1-Rapide (légumes et les poissons). 2-Super rapide (viandes et les ragoûts).
- Soupape de sécurité · Syst. de blocage de sécurité · Fenêtres latérales de sécurité.
- Apte pour tout type de feux.
- Fond FULL INDUCTION.

- Manufactured in high-quality 18/10 stainless steel.
- Inner marking, engraved with the cooker's capacity.
- Cooking level indicator-display using coloured rings.
- 2 cooking levels: 1-Fast (vegetables and fish). 2- Super-fast (meats and stews).
- Safety valve · Safety locking system · Side safety windows.
- Suitable for any type of hob.
- FULL INDUCTION base.



Niveles de cocción  
Cooking levels



Marcaje interior  
Inner marking

### Olla a presión

Cocotte à pression · Schnellkochtopf  
Pressure cooker · Painela de pressão

Ref	€	Ø (cm)	h(cm)	L	U.Venta
71884	81,50	22	15,5	4,0	1
71886	88,40	22	22,0	6,0	1
71887	106,60	24	23,5	8,0	1

# Tempo

INOX  
18/10

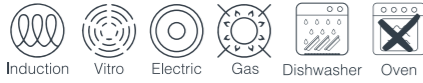

- Fabricada en acero inoxidable 18/10 de máxima calidad.
- Marcaje interior, grabado con la capacidad del uso de la olla.
- Válvula de control para seleccionar el nivel de presión.
- Niveles de cocción: cocción lenta y cocción rápida.
- Válvula de seguridad · Sistema de bloqueo de seguridad
- Ventanas laterales de seguridad.
- Apta para todo tipo de cocinas.
- Triple fondo FULL INDUCTION para una distribución rápida y homogénea del calor.

- Fabrication en acier inoxydable 18/10 de qualité maximale.
- Marquage intérieur, marquage gravé de la capacité d'utilisation de l'autocuiseur.
- Valve de contrôle pour sélectionner le niveau de pression
- Niveaux de cuisson : cuisson lente et cuisson rapide.
- Soupape de sécurité · Syst. de blocage de sécurité
- Fenêtres latérales de sécurité.
- Apte pour tout type de feux.
- INDUCTION TOTALE triple fond pour une distribution rapide et homogène de la chaleur.

- Manufactured in high-quality 18/10 stainless steel.
- Inner marking, engraved with the cooker's capacity.
- Control valve for selecting the power level.
- Cooking levels: slow cooking and fast cooking.
- Safety valve · Safety locking system.
- Side safety windows.
- Suitable for any type of hob.
- Tri-ply FULL INDUCTION base for quick, even heat distribution.



## Olla a presión

Cocotte à pression · Schnellkochtopf  
Pressure cooker · Panela de pressão

Ref	€	Ø (cm)	h(cm)	L	U.Venta
71864	89,60	22	15,0	4,0	1
71866	92,10	22	23,0	6,0	1
71868	98,90	22	27,0	8,0	1

## Set de ollas a presión

Ensemble de cocottes à pression · Schnellkochtopf-Satz  
Set of pressure cooker · Conj. de panelas de pressão

Ref	€	Ø (cm)	h(cm)	L	U.Venta
71862	140,50	22	16,0	6,0	1
		22	22,0	4,0	



# Sartenes Fryingpan







## Chef Inox Collection



- Fabricadas en acero inoxidable 18/10 de la mejor calidad.
- Máxima garantía en resistencia, durabilidad e higiene.
- Acabado interior y exterior lijado satinado.
- Fondo termodifusor sándwich, distribución rápida y uniforme del calor.
- Homogeneidad y eficacia térmica. Cocción ultrarrápida.
- Aptas para todos los fuegos.

- Fabriquées en acier inoxydable 18/10 de la meilleure qualité.
- Garantie maximale de résistance, de durabilité et d'hygiène.
- Finition interne et externe en brossage satiné.
- Fond thermo-diffuseur sandwich, distribution rapide et uniforme de la chaleur.
- Homogénéité et efficacité thermique. Cuisson ultra-rapide.
- Aptes pour tous les feux.

- Made of 18/10 stainless steel of the best quality.
- Maximum guarantee in resistance, durability and hygiene.
- Glossy sanded interior and exterior finish.
- Heat-diffusing sandwiched base, quick and even heat distribution.
- Thermal homogeneity and efficiency. Ultra-rapid cooking.
- Suitable for all types of cookers.



### Sartén Chef Classic

Poêle · Pfanne  
Frying-pan · Sertä

Ref	€	Ø (cm)	h(cm)	e (mm)	U.Venta
51620	42,00	20	4,0	1,0	1
51624	46,40	24	4,5	1,0	1
51628	56,20	28	5,5	1,0	1
51632	67,30	32	6,0	1,0	1
51636	84,40	36	6,5	1,0	1
51640	101,00	40	6,5	1,0	1



### Sartenes Chef Classic Plus

Poêle · Pfanne  
Frying-pan · Sertä

Ref	€	Ø (cm)	h(cm)	e (mm)	U.Venta
51621	51,60	20	4,0	1,0	1
51625	57,80	24	4,5	1,0	1
51629	69,70	28	5,5	1,0	1
51633	86,50	32	6,0	1,0	1
51637	112,10	36	6,5	1,0	1
51641	130,70	40	6,5	1,0	1



### Sartén Chef Classic Ceram

Poêle · Pfanne  
Frying-pan · Sertä

Ref	€	Ø (cm)	h(cm)	e (mm)	U.Venta
51720	53,30	20	4,0	1,0	1
51724	60,50	24	4,5	1,0	1
51728	73,00	28	5,5	1,0	1
51732	91,20	32	6,0	1,0	1
51736	113,00	36	6,5	1,0	1
51740	132,40	40	6,5	1,0	1

## Chef Alum Collection



- Sartenes fabricadas en aluminio de máxima calidad diseñadas para uso profesional.
- Recubrimiento antiadherente.
- Ecológico, libre de materiales tóxicos y pesados. Libre de PFOA.
- Aptas para todo tipo de cocinas, excepto inducción.

- Poêles fabriquées en aluminium de grande qualité conçues pour un usage professionnel.
- Revêtement antiadhésif.
- Écologique, exempt de matériaux toxiques et lourds. Sans PFOA.
- Compatible tous feux sauf induction, excepté induction.

- Pans made in top quality aluminium and design for professional use.
- Ecological, free of toxic and heavy materials. PFOA free.
- Suitable for all types of cooking surfaces, except induction.



### Sartenes Chef Tricapa

Poêle · Pfanne  
Frying pan · Sertä

Ref	€	Ø (cm)	h(cm)	e (mm)	U.Venta
21618	27,00	18	3,8	2,5	6
21620	29,60	20	4,0	3,5	6
21622	32,40	22	4,0	3,5	6
21624	35,70	24	4,5	3,5	6
21626	39,50	26	4,5	4,0	6
21628	45,00	28	4,5	4,0	6
21632	53,10	32	4,7	4,0	6
21636	63,30	36	5,5	4,0	4
21640	73,30	40	5,5	4,0	4



### Sartén honda Chef Tricapa

Poêle profonde · Tiefe Pfanne  
Deep frying-pan · Sertä funda

Ref	€	Ø (cm)	h(cm)	e (mm)	U.Venta
21524	54,60	24	6,5	3,5	1
21528	67,60	28	6,5	4,0	1



Induction



### Sartén Tricapa plus

Poêle avec fond · Pfanne mit Boden  
Frying-pan with botton · Sertä com fundo

Ref	€	Ø (cm)	h(cm)	e (mm)	U.Venta
* 21718	29,90	18	3,8	2,5	6
* 21720	34,00	20	4,0	3,5	6
* 21722	36,00	22	4,0	3,5	6
* 21724	39,90	24	4,5	3,5	6
* 21726	46,40	26	4,5	4,0	6
* 21728	49,90	28	4,5	4,0	6
* 21732	57,90	32	4,7	4,0	6
21736	70,80	36	5,5	4,0	4

\* Compatible con nuestro mango de silicona (Ref.: 23900)  
Compatible with our silicone handle (Ref.: 23900)

Acabado cerámico  
Ceramic finished



Induction



### Sartén Eco Chef

Poêle avec fond · Pfanne mit Boden  
Frying-pan with botton · Sertä com fundo

Ref	€	Ø (cm)	h(cm)	e (mm)	U.Venta
22718	32,20	18	3,8	2,5	6
22720	36,50	20	4,0	3,5	6
22722	39,90	22	4,0	3,5	6
22724	42,50	24	4,5	3,5	6
22726	49,30	26	4,5	4,0	6
22728	53,70	28	4,5	4,0	6
22732	63,00	32	4,7	4,0	6
22736	74,20	36	5,5	4,0	4

### Sartén Dynamic

Poêle · Pfanne  
Frying-pan · Sertä

Ref	€	Ø (cm)	h(cm)	e (mm)	U.Venta
23416	15,20	16	3,5	2,5	6
23418	16,40	18	3,5	2,5	6
* 23420	19,50	20	4,0	3,5	6
* 23422	22,90	22	4,0	3,5	6
* 23424	25,40	24	4,5	3,5	6
* 23426	30,30	26	4,5	4,0	6
* 23428	32,80	28	4,5	4,0	6
* 23432	39,50	32	4,7	4,0	6
23436	51,00	36	5,5	4,0	4

\* Compatible con nuestro mango de silicona (Ref.: 23900)  
Compatible with our silicone handle (Ref.: 23900)

# Sartenes Garinox

**garinox**<sup>®</sup>  
sartenes profesionales

new

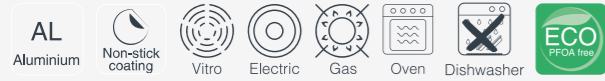

## Aine

- Fabricadas en aluminio de máxima calidad.
- Mango ergonómico de acero inoxidable.
- Máxima garantía en resistencia, durabilidad e higiene.
- Antiadherente ILAG ULTIMATE (Swiss Technology).
- Libre de materiales tóxicos y pesados, disolventes y sustancias químicas. 100% libre de PFOA.

- Made of top quality aluminium.
- Ergonomic stainless steel handle.
- Maximum guarantee in resistance, durability and hygiene.
- ILAG ULTIMATE non-stick coating (Swiss Technology).
- Free of toxic and heavy materials, solvents and chemicals. 100% PFOA-free.



### Sartén Aine

Poêle · Pflanne  
Frying-pan · Sertä



Ref	€	Ø (cm)	Ød (cm)	h(cm)	e (mm)	U.Venta
14518	13,20	18	13,0	4,5	2,5	1
14520	14,80	20	13,5	4,5	3,5	1
14522	16,50	22	14,5	4,5	3,5	1
14524	18,20	24	17,0	5,0	3,5	1
14526	19,50	26	18,0	5,0	3,5	1
14528	22,30	28	20,0	5,0	3,5	1
14532	27,30	32	21,0	5,7	3,5	1
14536	34,30	36	24,0	5,8	3,5	1
14540	40,40	40	27,0	6,4	3,5	1

## Kai

- Fabricadas en aluminio de máxima calidad.
- Mango de hierro forjado.
- Máxima garantía en resistencia, durabilidad e higiene.
- Antiadherente ILAG ULTIMATE (Swiss Technology).
- Libre de materiales tóxicos y pesados, disolventes y sustancias químicas. 100% libre de PFOA

- Made of top quality aluminium.
- Wrought iron handle.
- Maximum guarantee in resistance, durability and hygiene.
- ILAG ULTIMATE non-stick coating (Swiss Technology).
- Free of toxic and heavy materials, solvents and chemicals. 100% PFOA-free.



### Sartén Kai

Poêle · Pflanne  
Frying-pan · Sertä



Ref	€	Ø (cm)	Ød (cm)	h(cm)	e (mm)	U.Venta
14718	11,10	18	13,0	4,5	2,5	1
14720	14,20	20	13,5	4,5	3,5	1
14722	15,70	22	14,5	4,5	3,5	1
14724	17,40	24	17,0	5,0	3,5	1
14726	19,10	26	18,0	5,0	3,5	1
14728	21,40	28	20,0	5,0	3,5	1
14732	26,40	32	21,0	5,7	3,5	1
14736	33,20	36	24,0	5,8	3,5	1
14740	39,30	40	27,0	6,4	3,5	1

## Vukan

- Fabricadas en aluminio de máxima calidad.
- Mango ergonómico de acero inoxidable.
- Máxima garantía en resistencia, durabilidad e higiene.
- Nuevo antiadherente cerámico Fusion Pro de PPG™.
- Libre de materiales tóxicos y pesados, disolventes y sustancias químicas. 100% PFASfree.

- Made of top quality aluminium.
- Ergonomic stainless steel handle.
- Maximum guarantee of strength, durability and hygiene.
- New PPG™ Fusion Pro ceramic non-stick coating.
- Free of toxic and heavy materials, solvents and chemicals. 100% PFASfree.

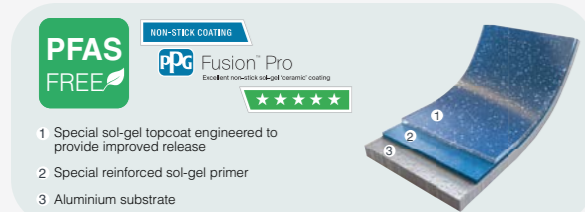

### Sartén Vukan

Poêle · Pflanne  
Frying-pan · Sertä



Ref	€	Ø (cm)	Ød (cm)	h(cm)	e (mm)	U.Venta
14818	13,20	18	13,0	4,5	2,5	1
14820	14,80	20	13,5	4,5	3,5	1
14822	16,50	22	14,5	4,5	3,5	1
14824	18,20	24	17,0	5,0	3,5	1
14826	19,50	26	18,0	5,0	3,5	1
14828	22,30	28	20,0	5,0	3,5	1
14832	27,30	32	21,0	5,7	3,5	1
14836	34,30	36	24,0	5,8	3,5	1
14840	40,40	40	27,0	6,4	3,5	1

## Adara / Kenna

- Fabricada en aluminio de máxima calidad.
- Fondo termodifusor sandwich, distribución rápida y uniforme del calor.
- Antiadherente ILAG ULTIMATE (Swiss Technology) 100% libre de PFOA.
- Libre de materiales tóxicos, pesados, disolventes y sustancias químicas.
- Apta para todos los fuegos.

- Made of top quality aluminium.
- Heat-diffusing sandwiched base, quick and even heat distribution.
- ILAG ULTIMATE (Swiss Technology) non-stick coating, 100% PFOA free.
- It's free of toxic materials, heavy metals, solvents and chemical substances.
- Suitable for all types of cookers.



Fondo termodifusor Sandwich



new



Induction

### Sartén ADARA

Poêle · Pflanne  
Frying-pan · Sertä



Ref	€	Ø (cm)	Ød (cm)	h(cm)	e (mm)	U.Venta
14590	17,30	20	13,0	4,5	3,5	1
14594	21,20	24	16,5	5,0	3,5	1
14598	25,70	28	19,0	5,0	3,5	1
14592	31,30	32	20,5	5,5	3,5	1



Induction

### Sartén KENNA

Poêle · Pflanne  
Frying-pan · Sertä



Ref	€	Ø (cm)	Ød (cm)	h(cm)	e (mm)	U.Venta
14790	16,60	20	13,0	4,5	3,5	1
14794	20,40	24	16,5	5,0	3,5	1
14798	25,00	28	19,0	5,0	3,5	1
14792	30,30	32	20,5	5,5	3,5	1



# Robust Collection



- Sartenes fabricadas en aluminio de máxima calidad diseñadas para uso profesional.
- Óptima distribución de calor conservando las propiedades nutritivas de los alimentos y con un mínimo gasto de aceite y energía.
- Recubrimiento antiadherente multicapa (5 capas) ecológico y libre de PFOA.
- Ideales para un uso continuo. Ligeras, manejables y fáciles de limpiar gracias a su antiadherente exterior.
- Aptas para todo tipo de cocinas, excepto inducción.

- Poêles fabriquées en aluminium de grande qualité conçues pour un usage professionnel.
- Distribution optimale de la chaleur en conservant les propriétés nutritives des aliments et avec une utilisation d'huile et d'énergie minimales.
- Revêtement antiadhésif multicouche (5 couches) écologique et sans PFOA.
- Idéales pour un usage continu. Légères, maniables et faciles à nettoyer grâce à leur revêtement antiadhésif extérieur.
- Compatibles avec tout type de cuisinière, excepté l'induction.

- Pans made in top quality aluminium and design for professional use.
- Optimal heat distribution, preserving the nutritional properties and with a minimal waste of oil and energy.
- Multi-layer (5 layers) eco-friendly non-stick coating, PFOA-free.
- Ideal for continuous use. Light, easy handling and easy to clean due to its nonstick exterior.
- Suitable for all types of cooking surfaces, except induction.

## Sartén

Poêle · Pfanne  
Frying-pan · Sertä

Ref	€	Ø (cm)	h(cm)	e (mm)	U.Venta
23616	15,20	16	3,5	2,5	6
23618	16,40	18	3,5	2,5	6
* 23620	19,50	20	4,0	3,5	6
* 23622	22,90	22	4,0	3,5	6
* 23624	25,10	24	4,5	3,5	6
* 23626	30,30	26	4,5	4,0	6
* 23628	32,50	28	4,5	4,0	6
* 23632	39,10	32	4,7	4,0	6
23636	51,00	36	5,5	4,0	4
23640	59,80	40	5,5	4,0	4

\* Compatible con nuestro mango de silicona (Ref.: 23900)  
Compatible with our silicone handle (Ref.: 23900)

## Sartén Robust Plus

Poêle · Pfanne  
Frying-pan · Sertä

Ref	€	Ø (cm)	h(cm)	e (mm)	U.Venta
23816	17,00	16	3,5	2,5	6
23818	18,20	18	3,5	2,5	6
23820	22,00	20	4,0	3,5	6
23822	24,80	22	4,0	3,5	6
23824	27,50	24	4,5	3,5	6
23826	31,90	26	4,5	4,0	6
23828	37,10	28	4,5	4,0	6
23832	43,00	32	4,7	4,0	6
23836	52,80	36	5,5	4,0	4
23840	63,80	40	5,5	4,0	4

## Sartén Honda

Poêle profonde · Tiefe Pfanne  
Deep frying-pan · Sertä funda

Ref	€	Ø (cm)	Ød (cm)	h(cm)	e (mm)	U.Venta
* 23625	42,90	24	18,5	6,5	3,5	1
* 23629	48,80	28	22,0	6,5	4,0	1

\* Compatible con nuestro mango de silicona (Ref.: 23900)  
Compatible with our silicone handle (Ref.: 23900)

## Sartén blinis

Poêle Blinis · Pfanne Blinis  
Frying-pan Blinis · Sertä Blinis

Ref	€	Ø (cm)	h(cm)	e (mm)	U.Venta
23612	11,70	12	2,1	2,5	6
23614	13,80	14	2,2	2,5	6

## Wok

Wok · Wok  
Wok · Wok

Ref	€	Ø (cm)	h(cm)	e (mm)	U.Venta
* 23830	45,00	30	7,0	4,0	1

\* Compatible con nuestro mango de silicona (Ref.: 23900)  
Compatible with our silicone handle (Ref.: 23900)

## Crepera

Crêpiere · Crêpes Pfanne  
Crepiere · Crepeira

Ref	€	Ø (cm)	h(cm)	e (mm)	U.Venta
* 23322	18,50	22	1,8	2,5	1
* 23326	23,30	26	1,8	2,7	1
* 23330	33,70	30	2,2	4,0	1

\* Compatible con nuestro mango de silicona (Ref.: 23900)  
Compatible with our silicone handle (Ref.: 23900)

## Sartén Oval

Poêle ova · Pfanne, oval  
Oval frying-pan · Sertä oval

Ref	€	cm	h(cm)	e (mm)	U.Venta
23637	65,40	36x26	5,0	2,7	1
23641	68,10	40x29	5,5	2,7	1

## Sartén rectangular

Poêle rectangulière · Pfanne, rechteckig  
Rectangular frying-pan · Sertä rectangular

Ref	€	cm	h(cm)	e (mm)	U.Venta
* 23638	57,20	38x26	5,0	4,0	1

\* Compatible con nuestro mango de silicona (Ref.: 23900)  
Compatible with our silicone handle (Ref.: 23900)

## Paellera

Plat rond · Paellapfanne  
Round dish · Paelheira

Ref	€	Ø (cm)	h(cm)	U.Venta
23724	23,40	24	4,00	1
23728	30,70	28	4,50	1
23732	36,20	32	5,00	1
23736	43,70	36	5,50	1
23740	54,00	40	6,00	1



## Wok Basic & Rustic



- Ideal para preparar salteados, quedando crujientes y conservando sus nutrientes.
- Duraderos y resistentes a arañazos.
- Alta conductividad térmica. El hierro al ser un excelente conductor del calor, permite conseguir y mantener la temperatura ideal de cocción con un menor consumo energético.
- Ligero y manejable.
- Mango ergonómico.
- Antiadherente tri-capa, libre de materiales tóxicos y pesados, ecológico y libre de PFOA.
- Fácil limpieza.
- Apta para todo tipo de cocinas, incluida la inducción.

- Idéal pour les sautés, les aliments restent croustillant et conservent leurs nutriments.
- Durable et résistant aux rayures.
- Haute conductivité thermique. Le métal, excellent conducteur de chaleur, permet d'obtenir et de maintenir la température de cuisson idéale avec une consommation d'énergie moins importante.
- Léger et maniable.
- Poignée ergonomique.
- Antiadhésif à trois couches, sans matériaux toxiques ni métaux lourds, écologique et sans PFOA.
- Nettoyage facile.
- Compatible avec tout type de cuisinières.

- Ideal for making stir-fries, keeping ingredients crisp and preserving their nutrients.
- Durable and scratch-resistant.
- High thermal conductivity. Being an excellent heat conductor, iron allows the ideal cooking temperature to be quickly reached and maintained using less energy consumption.
- Lightweight and practical.
- Ergonomic handle.
- Three-layer non-stick coating, free from toxic and heavy materials, environmentally friendly and PFOA-free.
- Easy to clean.
- Suitable for all types of cooking surfaces.

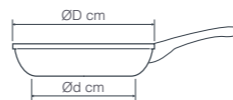

### Wok antiadherente Basic

Wok, Antiadherent · Wok, Antihaft  
Wok, Non-stick · Wok anti-aderente

Ref	€	Ø (cm)	Ød (cm)	h(cm)	e (mm)	U.Venta
63729	36,80	28	15	8,5	0,9	1
63733	37,40	32	15	9,5	0,9	1



### Wok antiadherente Rustic

Wok, Antiadherent · Wok, Antihaft  
Wok, Non-stick · Wok anti-aderente

Ref	€	Ø (cm)	Ød (cm)	h(cm)	e (mm)	U.Venta
66128	36,80	28	15	8,5	0,9	1
66132	37,40	32	15	9,5	0,9	1



## Ferrum Collection

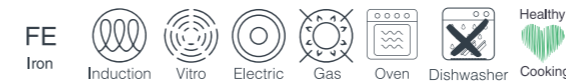

- Disfruta de una sartén para toda la vida.
- Fabricadas artesanalmente con 100% hierro natural.
- Calidad Premium; duraderas y resistentes a arañazos.
- Alta conductividad térmica. El hierro al ser un excelente conductor del calor, permite conseguir y mantener la temperatura ideal de cocción con un menor consumo energético.
- Espesor 2,5 mm. Fácil limpieza. Cocina ecológica, cocina saludable.
- Antiadherente premium, libre de PFOA (sartén antiadherente).

- Une poêle qui vous durera toute la vie.
- Fabriquées de façon artisanale avec 100% de métal naturel.
- Qualité Premium; durables et résistantes aux rayures.
- Haute conductivité thermique. Le métal, excellent conducteur de chaleur, permet d'obtenir et de maintenir la température de cuisson idéale avec une consommation d'énergie moins importante.
- Épaisseur 2,5mm. Nettoyage facile. Cuisine écologique, cuisine saine.
- Antiadhésif premium, sans PFOA (Poêle antiadherent).

- Enjoy this one pan your whole life.
- Hand-made in 100% natural iron.
- Premium Quality; long lasting and resistant to scratching.
- High heat conduction. Iron is an excellent conductor of heat, allowing you to obtain and maintain the ideal temperature with less energy consumption
- 2.5mm thickness. Easy to clean. Eco-friendly, healthy kitchen.
- Premium Quality; long lasting and resistant to scratching (Non-stick frying-pan).

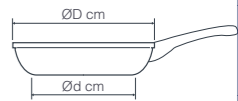

### Sartén

Poêle · Pflanne  
Frying-pan · Sertã

Ref	€	Ø (cm)	h(cm)	e (mm)	U.Venta
* 63620	30,80	20	3,5	2,5	1
* 63624	35,50	24	4,5	2,5	1
* 63626	38,30	26	4,5	2,5	1
* 63628	40,40	28	5,0	2,5	1
* 63632	48,40	32	5,3	2,5	1
63636	61,60	36	5,5	2,5	1
63640	68,30	40	5,8	2,5	1

\* Compatible con nuestro mango de silicona (Ref.: 23900)  
Compatible with our silicone handle (Ref.: 23900)

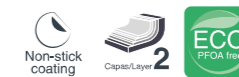

### Sartén antiadherente

Poêle antiadherent · Pflanne, Antihaft  
Frying-pan, non-stick · Sertã anti-aderente

Ref	€	Ø (cm)	h(cm)	e (mm)	U.Venta
* 63720	34,80	20	3,5	2,5	1
* 63724	38,30	24	4,5	2,5	1
* 63726	41,00	26	4,5	2,5	1
* 63728	43,40	28	5,0	2,5	1
* 63732	51,00	32	5,3	2,5	1
63736	64,40	36	5,5	2,5	1
63740	74,50	40	5,8	2,5	1

\* Compatible con nuestro mango de silicona (Ref.: 23900)  
Compatible with our silicone handle (Ref.: 23900)



### Sartén honda

Poêle profonde · Tiefe Pfanne  
Deep frying-pan · Sertã funda

Ref	€	Ø (cm)	h(cm)	e (mm)	U.Venta
* 63424	51,60	24	7,0	2,5	1
* 63428	59,70	28	8,0	2,5	1
* 63432	88,10	32	8,8	2,5	1

\* Compatible con nuestro mango de silicona (Ref.: 23900)  
Compatible with our silicone handle (Ref.: 23900)



### Sartén blinis

Poêle Blinis · Blinis Pfanne  
Blinis frying pan · Sertã Blinis

Ref	€	Ø (cm)	h(cm)	e (mm)	U.Venta
63613	25,70	12	2,1	2,0	6
63614	28,80	14	2,2	2,0	6



### Asador

Rôtissoire · Grill  
Rotisserie · Grelhador

Ref	€	Ø (cm)	h(cm)	e (mm)	U.Venta
* 63725	38,30	26	3,0	2,5	1

\* Compatible con nuestro mango de silicona (Ref.: 23900)  
Compatible with our silicone handle (Ref.: 23900)



### Cazo bombado

Casserole bombée · Kasserolle, Bauchig  
Rounded saucepan · Caçarola bojuda

Ref	€	Ø (cm)	h(cm)	e (mm)	U.Venta
* 63419	47,50	20	10	2,5	1
* 63423	59,70	24	12	2,5	1

\* Compatible con nuestro mango de silicona (Ref.: 23900)  
Compatible with our silicone handle (Ref.: 23900)



### Sartén blinis con antiadherente

Poêle Blinis antiadherent · Blinis Pfanne, Antihaft  
Blinis frying pan, Non-stick · Sertã Blinis anti-aderente

Ref	€	Ø (cm)	h(cm)	e (mm)	U.Venta
63712	27,10	12	2,1	2,0	6
63714	29,90	14	2,2	2,0	6



### Asador antiadherente

Rôtissoire, antiadherent · Grill, Antihaft  
Non-stick rotisserie · Grelhador anti-aderente

Ref	€	Ø (cm)	h(cm)	e (mm)	U.Venta
* 63727	39,50	26	3,0	2,5	1

\* Compatible con nuestro mango de silicona (Ref.: 23900)  
Compatible with our silicone handle (Ref.: 23900)

Asas de acero inoxidable  
Stainless steel handles



### Plancha grill

Plaque à Grill · Platte Grill  
Grill plaque · Plancha Grill

Ref	€	cm	h(cm)	e (mm)	U.Venta
63644	75,50	37x27	5,0	2,5	1



### Wok

Wok · Wok  
Wok · Wok

Ref	€	Ø (cm)	Ød (cm)	h(cm)	e (mm)	U.Venta
* 63828	49,70	28	15,0	8,0	2,0	1
* 63232	56,20	32	15,0	9,5	2,0	1

\* Compatible con nuestro mango de silicona (Ref.: 23900)  
Compatible with our silicone handle (Ref.: 23900)

Asas de acero inoxidable  
Stainless steel handles



### Plancha grill lisa

Plaque à Grill lisse · Platte Grill, glatt  
Grill flat plaque · Plancha Grill lisa

Ref	€	cm	h(cm)	e (mm)	U.Venta
63642	71,10	37x27	5,0	2,5	1



### Wok antiadherente

Wok, Antiadherent · Wok, Antihalt  
Wok, non-stick · Wok anti-aderente

Ref	€	Ø (cm)	Ød (cm)	h(cm)	e (mm)	U.Venta
* 63829	51,80	28	15,0	8,0	2,0	1
* 63233	59,10	32	15,0	9,5	2,0	1

\* Compatible con nuestro mango de silicona (Ref.: 23900)  
Compatible with our silicone handle (Ref.: 23900)

new



### Crepera

Crepière · Crêpes-Pfanne  
Crepiera · Crepeira

Ref	€	Ø (cm)	Ød (cm)	h(cm)	e (mm)	U.Venta
* 63322	26,60	22	20	1,8	2,5	1
* 63326	31,60	26	24	2,2	2,5	1

\* Compatible con nuestro mango de silicona (Ref.: 23900)  
Compatible with our silicone handle (Ref.: 23900)



### Crepera antiadherente

Crepière, antiadherent · Crêpes-Pfanne, Antihaft  
Crepiera, Non-stick · Crepeira anti-aderente

Ref	€	Ø (cm)	h(cm)	e (mm)	U.Venta
* 23323	27,90	22	1,8	2,5	1
* 23327	31,90	26	2,2	2,5	1

\* Compatible con nuestro mango de silicona (Ref.: 23900)  
Compatible with our silicone handle (Ref.: 23900)

Asas de acero inoxidable  
Stainless steel handles



### Paellera

Plat à paella · Paellapfanne  
Round dish for paella · Paelheira

Ref	€	Ø (cm)	h(cm)	e (mm)	Raciones	U.Venta
63928	58,70	28	4,5	2,5	3	1
63932	66,50	32	4,7	2,5	5	1
63936	82,90	36	5,5	2,5	7	1
63940	91,30	40	5,5	2,5	9	1

SI  
Silicone



### Protector de silicona

Protection en silicone · Silikonschutz  
Silicone handle cover · Protector de silicone

Ref	€	Largo (cm)	U.Venta
23900	6,60	13,5	1

- Mango protector de silicona de alta calidad para sartenes.
- Fácil de colocar, se ajusta perfectamente al mango de la sartén.
- Antideslizante y termorresistente, protege de las temperaturas elevadas.
- Compatible con nuestras sartenes Robust, Ferrum, Dynamic y Tricapa Plus (Ø16-32).

- High quality silicone protector mango for pans.
- Easy to place, it fits perfectly to the mango of the pan.
- Non -slip and thermor resistant, protects from high temperatures.
- Compatible with our Robust, Ferrum, Dynamic and Tricapa Plus (Ø16-32).

CRISTAL  
Glass



### Tapa de cristal

Couvercle en verre avec sortie de vapeur · Glasdeckel mit Dampfloch  
Glass Lid with steam hole · Tapa de vidrio con desvaporizador

Ref	€	Ø (cm)	U.Venta
71914	11,00	14	1
71916	11,30	16	1
71918	11,60	18	1
71920	12,50	20	1
71922	12,60	22	1
71924	13,20	24	1
71926	14,50	26	1
71928	15,10	28	1
71932	17,00	32	1

- Se adapta a todo tipo de baterías de cocina.
- Vidrio térmico resistente a altas temperaturas.
- Borde de acero inoxidable 18/10.

- Il s'adapte à tous les types de batteries de cuisine.
- Verre thermique résistante à haute température.
- 18/10 bord en acier inoxydable.

- It adapts to all types of kitchen batteries.
- High temperature resistant thermal glass.
- 18/10 stainless steel edge.

## Sartén Kale



- Fabricada en aluminio fundido. Robusta y duradera.
- Mango termo aislante, altamente resistente y ergonómico, permite un agarre seguro.
- Antiadherente de máxima calidad libre de materiales tóxicos y pesados, disolventes y sustancias químicas. 100 % libre de PFAS (libre de PFOA y PTFE)
- Distribución rápida y uniforme del calor gracias a su fondo FULL INDUCTION

- Fabriqué en fonte d'aluminium. Robuste et durable.
- Poignée très résistante, thermo-isolée et ergonomique conçue de manière ergonomique pour une bonne prise en main.
- Revêtement antiadhésif de la plus haute qualité, exempt de matériaux toxiques et lourds, de solvants et de produits chimiques. 100 % sans PFAS (sans PFOA ni PTFE).
- Distribution rapide et uniforme de la chaleur grâce au fond à FULL INDUCTION.

- Manufactured in cast aluminium. Strong and robust.
- Heat insulating, highly resistant and ergonomic handle, allows a secure grip.
- Top quality non stick coating free of toxic materials and heavy metals, solvents and chemical substances. 100% PFAS free (PFOA y PTFE free).
- Fast and uniform heat distribution thanks to its FULL INDUCTION base.



PFAS free



### Sartén Kale

Poêle · Pflanne  
Frying-pan · Sertä

Ref	€	Ø (cm)	Ød (cm)	h(cm)	U.Venta
26520	21,90	20	12,0	5,0	1
26522	23,50	22	14,5	5,5	1
26524	25,80	24	16,0	5,5	1
26526	28,50	26	17,0	5,5	1
26528	31,40	28	19,0	6,0	1

## Titanium PRO Collection



### Sartén

Poêle · Pflanne  
Frying-pan · Sertä

Ref	€	Ø (cm)	Ød (cm)	h(cm)	e (mm)	U.Venta
27820	31,50	20	16,6	5,0	1,9	6
27824	38,80	24	20,2	5,5	1,9	4
27828	47,10	28	23,4	6,0	1,9	6

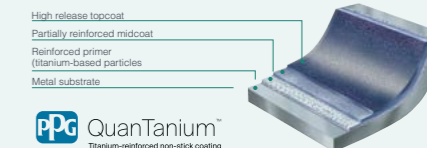

**Antiadherente QuanTanium® reforzado con partículas de titanio; libre de materiales tóxicos y pesados, ecológico y libre de PFOA**  
Antiadhésif QuanTanium® renforcé avec des particules de titane sans matériaux toxiques ni métaux lourds, écologique et sans PFOA.  
QuanTanium® non-stick reinforced with titanium particles; free from toxic and heavy materials, environmentally friendly and PFOA-free.



### Grill

Grill · Grill Induktionfähig  
Grill · Grelhador

Ref	€	cm	h(cm)	e (mm)	U.Venta
27827	54,90	28x28	4,0	1,8	1

4 in 1



### Sartén 4 cavidades

Poêle 4 cavités · Pflanne, 4-fache Einteilung  
Frying-pan 4 cavities · Sertä 4 cavidades

Ref	€	cm	h(cm)	e (mm)	U.Venta
27832	47,50	32x26	3,5	1,9	1

## Stilo Collection



### Sartén

Poêle · Pflanne  
Frying pan · Sertä

Ref	€	Ø (cm)	Ød (cm)	h(cm)	U.Venta
27620	35,50	20	16,5	4,5	6
27624	40,60	24	20,0	5,2	6
27626	44,80	26	21,5	5,5	6
27628	48,40	28	24,0	6,0	6



### Grill

Grill · Grill Induktionfähig  
Grill · Grelhador

Ref	€	cm	Ød (cm)	h(cm)	U.Venta
27625	44,80	24x24	18,6	4,8	1
27629	51,90	28x28	21,5	5,2	1



# Eco piedra Collection



- Fabricadas en aluminio fundido de gran calidad y espesor, están reforzadas con partículas a base de piedra y una máxima resistencia al rayado, duración y desgaste.
- La base de aluminio permite una distribución homogénea del calor, permitiendo que los alimentos se cocinen rápidamente y de manera uniforme, sin apenas utilizar aceite.
- Su antiadherente TRlcapa de máxima calidad y ecológico, es libre de PFOA.
- Fácil limpieza interior y exterior gracias al antiadherente.
- Fondo FULL INDUCTION compatible con todas las fuentes de calor, incluida la inducción.
- Excelente conductividad térmica.
- Se puede lavar en el lavavajillas.
- Paelleras · Planchas: asas fabricadas en silicona de máxima calidad, termo aislantes, altamente resistentes y ergonómicas, permiten un agarre seguro de la pieza.

- Fabriquées en fonte d'aluminium de grande qualité et épaisseur, elles sont renforcées par particules à base de pierre et confère une résistance maximale aux rayures et à l'usure pour allonger la durée de vie.
- La base en aluminium permet une distribution homogène de la chaleur, permettant aux aliments de se cuire rapidement et de façon uniforme, sans à peine utiliser d'huile Leur antiadhésif.
- Tri-couche d'une qualité maximale et écologique, est sans PFOA.
- Intérieur et extérieur faciles à nettoyer grâce à la protection antiadhésive.
- Fond « FULL INDUCTION » compatible avec toutes les sources de chaleur, y compris l'induction. Excellente conductivité thermique.
- Peuvent être lavées au lave-vaisselle.
- Plat à paella · Planches : poignées fabriquées en silicone de la plus grande qualité, thermo-isolantes, hautement résistantes et ergonomiques, qui permettent de tenir l'ustensile en toute sécurité.

- Made in high quality and thickness cast aluminium, it is reinforced with stone-based particles and maximum scratch and wear resistance and durability.
- The aluminium base allows for a homogeneous heat distribution, allowing the food to cook quickly and uniformly, without barely any oil.
- Its high quality and eco-friendly non-stick coating TRlcapa is PFOA-free.
- Easy to clean interior and exterior with its non-stick protection.
- FULL INDUCTION base that can be used with all kinds of heat sources, including induction cookers. Excellent thermal conductivity.
- Dishwasher safe.
- Round dish · Grill plaque: heat insulating, highly resistant, ergonomic handles made of high quality silicone which provide a secure grip on pots and pans.

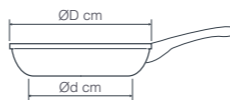

## Sartén

Poêle · Pfanne  
Frying pan · Sertä



Ref	€	Ø (cm)	Ød (cm)	h(cm)	e (mm)	U.Venta
24118	27,90	18	14,0	5,0	4,0	6
24120	31,70	20	14,5	5,0	4,0	6
24122	33,80	22	15,6	5,5	4,0	6
24124	36,70	24	17,4	6,0	4,0	6
24126	40,90	26	18,4	6,0	4,0	6
24128	43,50	28	20,5	6,0	4,0	6
24130	46,20	30	21,0	6,0	4,0	6

## Sartén blinis

Poêle Blinis · Pfanne Blinis  
Frying pan Blinis · Sertä Blinis



Ref	€	Ø (cm)	Ød (cm)	h(cm)	e (mm)	U.Venta
24114	13,40	14	10,0	5,6	4,0	1

## Wok

Wok · Wok  
Wok · Wok



Ref	€	Ø (cm)	Ød (cm)	h(cm)	e (mm)	U.Venta
24138	44,20	28	16,0	9,0	4,0	1

## Crepera

Crêpiere · Crêpes Pfanne  
Crepiere · Crepeira



Ref	€	Ø (cm)	Ød (cm)	h(cm)	e (mm)	U.Venta
24137	33,40	24	18,0	1,8	4,0	1
24136	37,10	26	17,0	1,8	4,0	1



## Grill

Grill · Grill  
Grill · Grelhador

Ref	€	cm	Ød (cm)	h(cm)	e (mm)	U.Venta
24123	38,10	24x24	16,7	4,5	4,0	1
24127	45,80	28x28	19,0	4,5	4,0	1
24125	38,20	24x24	16,7	4,5	4,0	1
24129	45,90	28x28	19,0	4,5	4,0	1



## Paellera

Plat à paella · Pfanne  
Round dish · Paelheira

Ref	€	Ø (cm)	Ød (cm)	h(cm)	e (mm)	Raciones	U.Venta
25432	76,50	32	25,5	4,5	1,6	5	1
25436	81,90	36	29,5	4,5	2,0	7	1
25440	95,50	40	33,5	4,5	2,0	9	1

Incluye asas de silicona  
Includes silicone handles



## Plancha grill oval

Plaque à Grill · Platte Grill  
Grill plaque · Plancha Grill



Ref	€	cm	Ød (cm)	Área de cocción	h(cm)	e (mm)	U.Venta
25536	38,00	37,5x23x4,5	18,0	25,5x20	1,5	4,0	1
25547	52,70	47,5x29x5,5	21,0	33,5x25	2,0	4,0	1



## Plancha grill

Plaque à Grill · Platte Grill  
Grill plaque · Plancha Grill



Ref	€	cm	Ød (cm)	Área de cocción	h(cm)	e (mm)	U.Venta
24134	66,90	46x27,5x6	24,0	33x25cm	2,0	4,0	1
24135	69,60	46x27,5x6	24,0	33x25cm	2,0	4,0	1

## Asas Eco piedra

Poignées pour plat rond · Griffschutz for Pfanne  
Handles for round dish · Asas para paelheira

Ref	€	Ø (cm)	U.Venta
R25436A	11,90	32-36-40	1

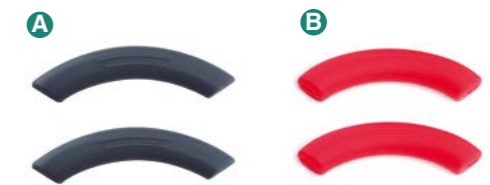

## Asas para plancha grill

Poignées pour plaque à Grill · Griffschutz for Platte Grill  
Handles for grill plaque · Asas para plancha Grill

Ref	€	cm	U.Venta
R25736A	4,10	36	1
R25747A	5,70	47	1
R25536A	4,10	36	1
R25547A	5,70	47	1

# TitanFull



- Fabricada en aluminio fundido de gran calidad.
- Diseñada para cocinar todo tipo de verduras, carnes, pescados, etc. de forma saludable y sin apenas utilizar aceite.
- Ahorro energético, hasta un 45% más eficiente, gracias a su fondo FULL INDUCTION.
- Distribución homogénea del calor: permite que los alimentos se cocinen rápidamente y de manera uniforme.
- Diseñada para uso doméstico y rendimiento profesional.
- Máxima resistencia al desgaste.
- Compatible con todo tipo de cocinas.

- Fabriqué en aluminium fondu de grande qualité.
- Conçu pour cuire toutes sortes de légumes, viandes, poissons, etc. Sain et à peine utilisé de l'huile.
- Économies d'énergie, jusqu'à 45% plus efficaces, grâce à son fonds d'induction complet.
- Distribution de la chaleur homogène: permet aux aliments de cuire rapidement et uniformément.
- Conçu pour un usage domestique et des performances professionnelles.
- Résistance à l'usure maximale.
- Compatible avec tous les types de cuisines, y compris l'induction.

- Made of great quality molten aluminum.
- Designed to cook all kinds of vegetables, meats, fish, etc.
- Healthy and hardly use oil.
- Energy savings, up to 45% more efficient, thanks to its Full Induction fund.
- Homogeneous heat distribution: Allows food to cook quickly and uniformly.
- Designed for domestic use and professional performance.
- Maximum wear resistance.
- Compatible with all types of kitchens, including induction.

Incluye asas de silicona  
Includes silicone handles



## Plancha grill

Plaque à Grill · Platte Grill  
Grill plaque · Plancha Grill

Ref	€	Área de cocción	h(cm)	e (mm)	U.Venta
24347	113,50	28x28	3	5,0	1

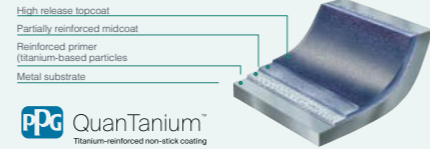

**Antiadherente QuanTanium® reforzado con partículas de titanio; libre de materiales tóxicos y pesados, ecológico y libre de PFOA**  
Antiadhésif QuanTanium® renforcé avec des particules de titane sans matériaux toxiques ni métaux lourds, écologique et sans PFOA.  
QuanTanium® non-stick reinforced with titanium particles; free from toxic and heavy materials, environmentally friendly and PFOA-free.

# Sua



- Sartén parrilla grill fabricada en aluminio fundido de máxima calidad.
- Acabado antiadherente bicapa de alta calidad y 100% libre de PFOA. Libre de materiales tóxicos, pesados, disolventes y sustancias químicas.
- Diseñada para una cocina saludable: permite cocinar sin apenas aceite garantizando que los alimentos no se peguen.
- Máxima eficiencia y ahorro de energía; su fondo difusor FULL INDUCTION está especialmente diseñado para repartir el calor de manera rápida y uniforme a lo largo de toda la superficie (base + paredes), consiguiendo así que los alimentos se cocinen de forma uniforme por toda la superficie.

- Grill Sergeén Grill fabriqué en aluminium fondu de qualité maximale.
- Finition anti-bicouche de haute qualité et 100% exempt de PFOA. Sans matériaux toxiques, lourds, solvants et chimiques.
- Conçu pour une cuisine saine: il permet de cuisiner avec presque aucune huile garantissant que la nourriture ne colle pas.
- Efficacité maximale et économies d'énergie; Son fond de diffuseur complet à induction est spécialement conçu pour distribuer la chaleur rapidement et uniformément sur toute la surface (base + murs), faisant ainsi cuire les aliments uniformément sur la surface.

- Grill grill manufactured in molten aluminum of maximum quality.
- High quality bilayer anti-sticking finish and 100% free from PFOA. Free of toxic, heavy, solvents and chemical materials.
- Designed for a healthy kitchen: it allows cooking with hardly any oil guaranteeing that food does not stick.
- Maximum efficiency and energy savings; Its Full Induction diffuser background is specially designed to distribute heat quickly and uniformly along the entire surface (base + walls), thus getting food cook uniformly throughout the surface.

Mango abatible de madera de roble  
Wooden folded handle



## Sartén grill

Gril · Grill Induktionfähig  
Grill · Grelhador

Ref	€	cm	h(cm)	e (mm)	U.Venta
25144	28,40	24x24	3,7	1,7	1
25148	34,50	28x28	3,8	1,7	1

## Sartén grill liso

Grill lisse · Grill Induktionfähig, glatt  
Grill flat · Grelhador liso

Ref	€	cm	h(cm)	e (mm)	U.Venta
25154	28,40	24x24	3,7	1,7	1
25158	34,50	28x28	3,8	1,7	1



ROUGH SURFACE  
+ RESISTANT + DURABILITY

# Java Collection

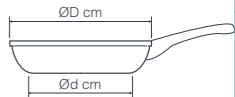

- Fabricada en aluminio forjado de máxima calidad.
- Antiadherente interior y exterior reforzado a base de partículas de piedra.
- Ecológico, libre de materiales tóxicos y pesados. Libre de PFOA.
- Fondo FULL INDUCTION compatible con todas las fuentes de calor, incluida la inducción. Excelente conductividad térmica.

- Fabriqué en aluminium forgé de la plus grande qualité.
- Antiadhésif intérieur et extérieur renforcé à base de particules de pierre.
- Écologique, exempt de matériaux toxiques et lourds. Sans PFOA.
- Fond « FULL INDUCTION » compatible avec toutes les sources de chaleur, y compris l'induction. Excellente conductivité thermique.

- Made of high quality forged aluminum.
- Reinforced non-stick coating inside and outside using stone particles.
- Ecological, free of toxic and heavy materials. PFOA free.
- FULL INDUCTION base that can be used with all kinds of heat sources, including induction cookers. Excellent thermal conductivity.

## Sartén

Poêle · Pfanne  
Frying-pan · Sertã

Ref	€	Ø (cm)	Ød (cm)	h(cm)	e (mm)	U.Venta
26816	14,40	16	13,0	4,0	3,0	6
26818	15,40	18	13,8	4,0	3,0	6
26820	16,90	20	15,6	4,0	3,0	6
26822	19,00	22	17,4	4,5	3,0	6
26824	20,60	24	19,0	4,5	3,0	6
26826	22,80	26	20,4	5,0	3,0	6
26828	24,80	28	22,4	5,5	3,0	6
26830	27,50	30	23,7	5,5	3,0	6
26832	38,20	32	25,0	5,5	3,0	6



## Wok

Wok · Wok  
Wok · Wok

Ref	€	Ø (cm)	Ød (cm)	h(cm)	e (mm)	U.Venta
26848	24,40	28	17,5	8,0	3,0	1



## Crepera

Crêpiere · Crêpes Pfanne  
Crepiere · Crepeira

Ref	€	Ø (cm)	Ød (cm)	h(cm)	e (mm)	U.Venta
26844	19,10	24	21,6	2,0	3,0	1



## Sartén honda

Poêle profonde · Tiefe Pfanne  
Deep frying-pan · Sertã funda

Ref	€	Ø (cm)	Ød (cm)	h(cm)	e (mm)	U.Venta
26834	22,00	24	18,5	6,5	3,0	1
26838	26,00	28	22,2	7,0	3,0	1



## Grill

Grill · Grill Induktionfähig  
Grill · Grelhador

Ref	€	cm	Ød (cm)	h(cm)	e (mm)	U.Venta
26858	27,80	28 x 28	24,2	4,5	3,0	1





# Set Fogo



- Set de dos sartenes de aluminio forjado de máxima calidad.
- Recubrimiento antiadherente TRICapa reforzado con partículas a base de piedra, libre de materiales tóxicos y pesados.
- Ecológico y libre de PFOA.
- Ahorro energético, hasta un 45% más eficiente, gracias a su fondo difusor FULL INDUCTION.
- La base de aluminio permite una distribución homogénea del calor, permitiendo que los alimentos se cocinen rápidamente y de manera uniforme, sin apenas utilizar aceite.
- Máxima resistencia al desgaste.
- Mango ergonómico y antideslizante.
- Apilables.
- Fácil limpieza interior y exterior gracias a su protección antiadherente.

- Ensemble de deux moules en aluminium forgé de qualité maximale.
- Revêtement anti-droit à base droite avec des particules à base de pierre, exemptes de matériaux toxiques et lourds.
- Écologique et sans PFOA.
- Économies d'énergie, jusqu'à 45% plus efficaces, grâce à son fonds complet du fonds d'induction.
- La base en aluminium permet une distribution homogène de la chaleur, permettant aux aliments de cuire rapidement et uniformément, avec presque aucune huile.
- Résistance à l'usure maximale.
- Mango ergonomique et non glissant.
- Empilable.
- Nettoyage intérieur et extérieur facile grâce à sa protection non-assise.

- Set of two maximum quality wrought aluminum pans.
- Straight -based antiating coating with stone -based particles, free of toxic and heavy materials.
- Ecological and free of PFOA.
- Energy savings, up to 45% more efficient, thanks to its Full Induction Fund Fund.
- The aluminum base allows a homogeneous distribution of heat, allowing food to cook quickly and uniformly, with hardly any oil.
- Maximum wear resistance.
- Ergonomic and non -slip mango.
- Stackable.
- Easy interior and exterior cleaning thanks to its non -stick protection.
- Compatibility: all types of kitchens, including induction.

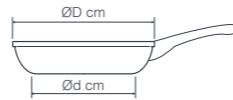

**Set 2 sartenes**  
Set 2 poêles · Set 2 Bratpfannen  
Set 2 frying pans · Conjunto 2 sertās

Ref	€	Ø (cm)	Ød (cm)	h(cm)	e (mm)	U.Venta
26400	<b>34,70</b>	20	14,5	4,2	3,0	1
		24	18,0	4,7	3,0	

# Vite



- Sartén fabricada en aluminio de máxima calidad.
- Máxima eficiencia y ahorro de energía; cuenta con un fondo difusor full induction para asegurar un rendimiento óptimo en todo tipo de cocinas con un reparto de calor inmejorable.
- Recubrimiento antiadherente de máxima calidad.
- Libre de materiales pesados y tóxicos, ecológico y libre de PFOA.
- Gracias a su fondo full induction, es compatible con todas las fuentes de calor, incluida la inducción.

- Singerén fabriqué en aluminium de qualité maximale.
- Efficacité maximale et économies d'énergie; Il a un diffuseur à induction complet pour assurer des performances optimales dans tous les types de cuisines avec une distribution de chaleur imbattable.
- Évaluation anticatante de la qualité maximale.
- Sans matériaux lourds et toxiques, écologiques et exempts de PFOA.
- Grâce à son fonds d'induction complet, il est compatible avec toutes les sources de chaleur, y compris l'induction.

- Singerén manufactured in aluminum of maximum quality.
- Maximum efficiency and energy savings; It has a full induction diffuser back to ensure optimal performance in all types of kitchens with an unbeatable heat distribution.
- Antiating coating of maximum quality.
- Free of heavy and toxic materials, ecological and free of PFOA.
- Thanks to its Full Induction fund, it is compatible with all heat sources, including induction.



**Sartén**  
Poêle · Pflanne  
Frying-pan · Sertā

Ref	€	Ø (cm)	Ød (cm)	h(cm)	e (mm)	U.Venta
26718	<b>12,70</b>	18	11,5	4,0	3,0	6
26720	<b>14,30</b>	20	14,3	4,0	3,0	6
26722	<b>16,20</b>	22	16,6	4,5	3,0	6
26724	<b>17,90</b>	24	17,0	4,5	3,0	6
26726	<b>20,40</b>	26	19,0	5,0	3,0	6
26728	<b>22,60</b>	28	21,5	5,0	3,0	6
26730	<b>24,30</b>	30	21,2	5,5	3,0	6

# Easy Collection



- Fabricada en aluminio forjado de máxima calidad.
- Recubrimiento antiadherente Whitford reforzado de máxima calidad y libre de PFOA.
- Antiadherente interior reforzado a base de partículas de piedra.
- Fondo full induction compatible con todas las fuentes de calor, incluida la inducción.
- Excelente conductividad térmica.
- Mango de fundición de acero inoxidable.

- Fabriqué en aluminium forgé de qualité maximale.
- Straid Whitford revêtement renforcé et exempt de PFOA.
- Basé sur Internet basé sur Internet.
- Fonds complet à induction compatible avec toutes les sources de chaleur, y compris l'induction.
- Excellente conductivité thermique.
- Poignée coulée en acier inoxydable.

- Made of maximum quality forged aluminum.
- Straid Whitford Coating Reinforced and free of PFOA.
- Internal internet based based based based.
- Full Induction Fund compatible with all heat sources, including induction.
- Excellent thermal conductivity.
- Stainless steel casting mango.

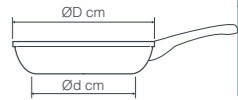

**Sartén Easy**  
Poêle · Pflanne  
Frying-pan · Sertā

Ref	€	Ø (cm)	h(cm)	e (mm)	L	U.Venta
27018	<b>21,10</b>	18	4,0	3,0	0,75	6
27020	<b>21,90</b>	20	4,0	3,0	1,0	6
27022	<b>23,70</b>	22	4,5	3,0	1,3	6
27024	<b>25,70</b>	24	4,5	3,0	1,7	6
27026	<b>27,90</b>	26	5,0	3,0	2,1	6
27028	<b>30,60</b>	28	5,5	3,0	2,7	6
27030	<b>33,50</b>	30	5,5	3,0	3,1	6
27032	<b>35,40</b>	32	6,0	3,0	3,7	6



**Sartén Honda**  
Poêle profonde · Tiefs Pflanne  
Deep frying-pan · Sertā funda

Ref	€	Ø (cm)	Ød (cm)	h(cm)	e (mm)	U.Venta
27134	<b>31,20</b>	24	16,00	6,5	3,0	1
27138	<b>37,30</b>	28	21,00	7,0	3,0	1



**Wok**  
Wok · Wok  
Wok · Wok

Ref	€	Ø (cm)	Ød (cm)	h(cm)	e (mm)	U.Venta
27148	<b>35,00</b>	28	16,00	8,0	3,0	1



**Grill**  
Grill · Grill Inductionfåhing  
Grill · Grelhador

Ref	€	cm	h(cm)	e (mm)	U.Venta
27158	<b>38,50</b>	28x28	4,0	3,0	1



**Crepera**  
Crépiere · Crêpes Pflanne  
Crepiere · Crepeira

Ref	€	Ø (cm)	Ød (cm)	h(cm)	e (mm)
27144	<b>27,60</b>	19,0	4,0	3,0	1

# Voga



- Fabricada en aluminio forjado, acabado fuerte y robusto.
- Calentamiento rápido y uniforme.
- Recubrimiento antiadherente ILAG:ULTIMATE (tricapa) de gran calidad ultrarresistente y de uso intensivo.
- Mango de acero inoxidable, no se calienta.

- Fabriqué en aluminium forgé, une finition solide et robuste.
- Réchauffement rapide et uniforme.
- ILAG: Ultimate (Tricapa) revêtement antiadhérent (Tricapa) d'une grande utilisation ultra-résistante et intensive.
- Mango en acier inoxydable, ne chauffez pas.

- Made of forged aluminium, strong and robust finish.
- Fast and uniform warming.
- ILAG: Ultimate (tricapa) antiadherent coating (tricapa) of great ultra-resistant and intensive use.
- Stainless steel mango, do not heat up.

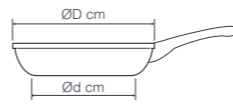

## Sartén Voga

Poêle · Pfanne  
Frying-pan · Sertä

Ref	€	Ø (cm)	Ød (cm)	h(cm)	e (mm)	U.Venta
24720	33,40	20	14,6	4,5	4,0	6
24722	36,50	22	15,6	5,0	4,0	6
24724	40,90	24	17,7	5,0	4,0	6
24726	45,20	26	18,8	5,5	4,0	6
24728	48,40	28	20,4	6,0	4,0	6
24732	56,40	32	23,3	6,5	4,0	6

# Fit



- Gracias al tratamiento electrolítico empleado en su proceso de fabricación, el aluminio se sella completamente y se endurece para que no pase a los alimentos.
- Gran durabilidad y ultrarresistente: superficie robusta altamente resistente a roces, deformación y corrosión.
- Difunde el calor de forma uniforme evitando el sobrecalentamiento y obteniendo excelentes resultados de cocción.
- Mango de acero inoxidable con remaches de aluminio que impiden la transferencia de calor.
- Compatible con todas las fuentes de calor, incluida la inducción.

- Grâce au traitement électrolytique utilisé dans son processus de fabrication, l'aluminium est complètement scellé et durcit afin qu'il ne passe pas à la nourriture.
- Grande durabilité et ultra-résistant: surface robuste très résistante aux frictions, à la déformation et à la corrosion.
- Diffuser la chaleur uniformément en évitant de surchauffer et obtenir d'excellents résultats de cuisson.
- Mango en acier inoxydable avec des rivets en aluminium qui empêchent le transfert de chaleur.
- Compatible avec toutes les sources de chaleur, y compris l'induction.

- Thanks to the electrolytic treatment used in its manufacturing process, aluminum is completely sealed and hardens so that it does not pass to food.
- Great durability and ultra-resistant: robust surface highly resistant to friction, deformation and corrosion.
- Disseminate heat evenly avoiding overheating and obtaining excellent cooking results.
- Stainless steel mango with aluminum rivets that prevent heat transfer.
- Compatible with all heat sources, including induction.

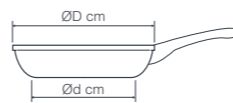

## Sartén

Poêle · Pfanne  
Frying pan · Sertä

Ref	€	Ø (cm)	Ød (cm)	h(cm)	e (mm)	U.Venta
48720	33,20	20	15,0	4,0	4,5	6
48724	41,50	24	18,0	4,5	4,5	6
48728	49,50	28	22,0	5,0	4,5	6

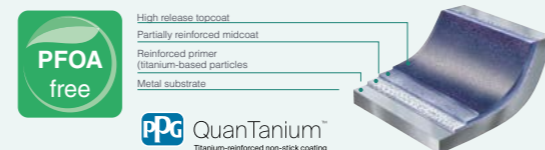

**Antiadherente QuanTanium® reforzado con partículas de titanio; libre de materiales tóxicos y pesados, ecológico y libre de PFOA**  
Antiadhésif QuanTanium® renforcé avec des particules de titane sans matériaux toxiques ni métaux lourds, écologique et sans PFOA.  
QuanTanium® non-stick reinforced with titanium particles; free from toxic and heavy materials, environmentally friendly and PFOA-free.

# Loft



- Fabricada en aluminio embutido, acabado fuerte y robusto.
- Recubrimiento antiadherente. Calidad y larga duración.
- Exterior en negro mate.
- Calentamiento rápido y uniforme.

- Fabriquée en aluminium embouti, finition forte et robuste.
- Revêtement antiadhésif. Qualité et longue durée de vie.
- Extérieur en noir mat.
- Chauffe rapide et uniforme.

- Made from deep drawn aluminium, strong and robust finish.
- Non-stick coating. Quality and long life.
- Outside in matte black.
- Quick and uniform heating.

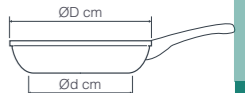

Mango SOFT TOUCH  
SOFT TOUCH handle

## Sartén

Poêle · Pfanne  
Frying pan · Sertä

Ref	€	Ø (cm)	Ød (cm)	h(cm)	e (mm)	U.Venta
24918	19,40	18	13,5	3,8	3,5	6
24920	21,30	20	14,7	4,3	3,5	6
24922	22,90	22	16,5	4,3	3,5	6
24924	25,60	24	17,6	4,8	3,5	6
24926	27,30	26	19,0	4,8	3,5	6
24928	31,50	28	22,1	5,3	3,5	6





## Trimetal Collection



- **Cuerpo fabricado en 3 capas: acero inoxidable 18/10, aluminio, acero inoxidable 18%.**
- **La capa exterior es de acero inoxidable con componentes ferríticos, lo que la convierte totalmente compatible con las cocinas de inducción.**
- **Mango fabricado en acero inoxidable 18/10 y recubierto con un protector térmico de silicona para facilitar un agarre perfecto y seguro.**

- Corps fabriqué en 3 couches: 18/10 en acier inoxydable, aluminium, 18% en acier inoxydable.
- La couche externe est en acier inoxydable avec des composants ferritiques, ce qui le rend entièrement compatible avec les cuisines à induction.
- Mango en acier inoxydable 18/10 et recouvert d'un protecteur thermique en silicone pour faciliter une adhérence parfaite et sûre.

- Body manufactured in 3 layers: 18/10 stainless steel, aluminum, 18% stainless steel.
- The outer layer is stainless steel with ferritic components, which makes it fully compatible with induction kitchens.
- Mango made of stainless steel 18/10 and covered with a silicone thermal protector to facilitate a perfect and safe grip.



### Sartén antiadherente

Poêle antiadherent · Pflanne, Antihalt  
Non-stick frying pan · Sertã anti-aderente

Ref	€	Ø (cm)	h(cm)	e (mm)	U.Venta
53721	69,90	20	4,5	2,3	1
53725	83,60	24	5,0	2,3	1
53729	105,60	28	5,5	2,3	1

### Sartén

Poêle · Pflanne  
Frying pan · Sertã

Ref	€	Ø (cm)	h(cm)	e (mm)	U.Venta
53720	59,40	20	4,5	2,3	1
53724	66,20	24	5,0	2,3	1
53728	81,10	28	5,5	2,3	1



### Wok antiadherente

Wok, Antiadherent · Wok, Antihalt  
Wok, non-stick · Wok anti-aderente

Ref	€	Ø (cm)	h(cm)	e (mm)	U.Venta
53829	100,20	28	8,0	2,3	1

### Wok

Wok · Wok  
Wok · Wok

Ref	€	Ø (cm)	h(cm)	e (mm)	U.Venta
53828	88,10	28	8,0	2,3	1

## TriChef



- **El aluminio interior garantiza una distribución rápida y uniforme del calor, así como un importante ahorro en el uso de la energía.**
- **Mango ergonómico fabricado en fundición de acero inoxidable 18/10 de gran calidad.**
- **Apta para todo tipo de cocinas, especialmente para la inducción.**
- **Máxima garantía en cuanto a resistencia, durabilidad e higiene.**
- **Apta para el horno (hasta 260°C) y lavavajillas.**

- L'aluminium intérieur garantit une distribution rapide et uniforme de chaleur, ainsi que d'importantes économies d'énergie.
- Poignée ergonomique fabriquée en fonte d'acier inoxydable 18/10 de grande qualité.
- Apte pour tous types de cuisinières, particulièrement l'induction.
- Garantie maximale en termes de résistance, durabilité et hygiène.
- Apte pour le four (jusqu'à 260°C) et le lave-vaisselle.

- The aluminium layer inside ensures fast, even heat distribution to the food and significant energy saving costs.
- Ergonomic handles made of high quality 18/10 cast stainless steel.
- Suitable for all hobs, especially induction.
- Maximum guarantee in terms of strength, durability and hygiene.
- Oven (up to 260°) and dishwasher safe.

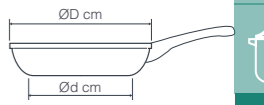

- 1.- Acero inoxidable 18/10 · 18/10 stainless steel
- 2.- Aluminio · Aluminium
- 3.- Acero inoxidable inducción · Induction stainless steel

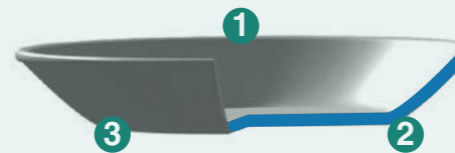

High release topcoat  
Partially reinforced midcoat  
Reinforced primer  
(titanium-based particles)  
Metal substrate

PPG QuanTanium™  
Titanium-reinforced non-stick coating

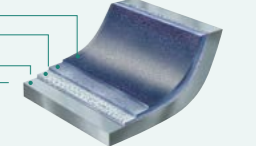

**Antiadherente QuanTanium® reforzado con partículas de titanio; libre de materiales tóxicos y pesados, ecológico y libre de PFOA**  
Antiadhésif QuanTanium® renforcé avec des particules de titane sans matériaux toxiques ni métaux lourds, écologique et sans PFOA.  
QuanTanium® non-stick reinforced with titanium particles; free from toxic and heavy materials, environmentally friendly and PFOA-free.



### Sartén

Poêle · Pflanne  
Frying pan · Sertã

Ref	€	Ø (cm)	Ød (cm)	h(cm)	e (mm)	U.Venta
60850	31,70	20	16,5	4,3	2,5	1
60854	39,60	24	20,5	4,8	2,5	1
60858	48,10	28	24,5	5,3	2,5	1



### Sartén antiadherente

Poêle antiadherent · Pflanne, Antihalt  
Non-stick frying pan · Sertã anti-aderente

Ref	€	Ø (cm)	Ød (cm)	h(cm)	e (mm)	U.Venta
60950	37,50	20	16,5	4,3	2,5	1
60954	46,00	24	20,5	4,8	2,5	1
60958	56,20	28	24,5	5,3	2,5	1

## Sartén Vitrocor



- **Fabricada en acero inoxidable 18/10 de la mejor calidad.**
- **Máxima garantía en cuanto a resistencia, durabilidad e higiene.**
- **Fondo termodifusor sándwich, distribución rápida y uniforme del calor.**
- **Homogeneidad y eficacia térmica. Cocción ultrarrápida.**
- **Apta para todos los fuegos.**

- Made of stainless steel 18/10 of the best quality.
- Maximum guarantee in terms of resistance, durability and hygiene.
- Sandwich thermodifusor background, rapid and uniform distribution of heat.
- Homogeneity and thermal efficacy. Ultra-grape cooking.
- Suitable for all fires.



### Sartén Vitrocor

Poêle · Pflanne  
Frying pan · Sertã

Ref	€	Ø (cm)	h(cm)	e (mm)	U.Venta
40619	33,80	18	4,5	0,7	1
40621	36,00	20	4,5	0,7	1
40623	37,30	22	5,0	0,7	1
40625	39,90	24	5,2	0,7	1
40627	41,10	26	6,0	0,7	1
40629	44,10	28	6,5	0,7	1

# Home collection



- **Máxima garantía en cuanto a resistencia, durabilidad e higiene.**
- **Antiadherente Eclipse Plus tricapa de uso intensivo. Libre de PFOA.**
- **Fondo termodifusor sándwich; distribución rápida y uniforme del calor.**
- **Homogeneidad y eficacia térmica. Cocción ultrarrápida.**

- Garantie maximale en termes de résistance, de durabilité et d'hygiène.
- Éclipse anticulante plus tricap d'utilisation intensive. PFOA gratuit.
- Fond de thermodifusor sandwich; Distribution rapide et uniforme de la chaleur.
- Homogénéité et efficacité thermique. Cuisine ultra-graphe.

- Maximum guarantee in terms of resistance, durability and hygiene.
- Antiating Eclipse Plus tricap of intensive use. PFOA free.
- Sandwich thermodifusor background; Quick and uniform distribution of heat.
- Homogeneity and thermal efficacy. Ultra-grape cooking



**Sartén lisa**  
Poêle, lisse · Pfanne, glatt  
Frying-pan flat · Sertä

Ref	€	Ø (cm)	h(cm)	e (mm)	U.Venta
71318	38,90	18	5,5	0,7	1
71320	40,90	20	5,5	0,7	1
71322	45,50	22	5,5	0,7	1
71324	49,80	24	6,0	0,7	1
71326	54,80	26	6,0	0,7	1
71328	61,40	28	6,5	0,7	1



**Sartén acanalada**  
Poêle · Pfanne  
Frying-pan · Sertä

Ref	€	Ø (cm)	h(cm)	e (mm)	U.Venta
71818	38,90	18	5,5	0,7	1
71820	40,90	20	5,5	0,7	1
71822	45,50	22	5,5	0,7	1
71824	49,80	24	6,0	0,7	1
71826	54,80	26	6,0	0,7	1
71828	61,40	28	6,5	0,7	1

# Sartenes Combi



**Mango**  
Poignée · Griff  
Handle · Cabo

Ref	€	Color	U.Venta
56601	14,60	Negro · Black	1
56605	14,80	Azul · Blue	1
56603	14,80	Rojo · Red	1



**Ahorra espacio de almacenaje**  
Saves storage space



**Cuerpo para tartera/sartén Combi**  
Corps pourplat rond/poêle · Körper für Pfanne/Pfanne  
Body for round dish/frying pan · Corpo para tarteira/sertä

Ref	€	Ø (cm)	h(cm)	e (mm)	L	U.Venta
56720	24,30	20	4,0	0,8	1,00	1
56724	30,20	24	4,5	0,8	2,00	1
56728	41,00	28	5,0	0,8	3,00	1
56732	48,90	32	5,5	0,8	4,00	1



**Cuerpo para tartera/sartén Combi antiadherente**  
Corps pourplat rond/poêle · Körper für Pfanne/Pfanne  
Body for round dish/frying pan · Corpo para tarteira/sertä

Ref	€	Ø (cm)	h(cm)	e (mm)	L	U.Venta
56820	31,70	20	4,0	0,8	1,00	1
56824	38,40	24	4,5	0,8	2,00	1
56828	51,10	28	5,0	0,8	3,00	1
56832	59,30	32	5,5	0,8	4,00	1

# Foodie collection



- **Fabricada en acero inoxidable 18/10.**
- **Mango ergonómico fabricado en acero inoxidable fundido.**
- **Natural y ecológica. Libre de materiales tóxicos y pesados.**
- **Fondo termo difusor sándwich, distribución rápida y homogénea del calor.**
- **Máxima garantía en cuanto a resistencia, durabilidad e higiene.**
- **Acabado interior y exterior lijado satinado.**

- Fabriqué en acier inoxydable 18/10.
- Mango ergonomique en acier inoxydable coulé.
- Naturel et écologique. Sans matériaux toxiques et lourds.
- Sandwich au diffuseur Thermo Fund, distribution rapide et homogène de la chaleur.
- Garantie maximale en termes de résistance, de durabilité et d'hygiène.
- Satin de finition interne et extérieure.

- Made of stainless steel 18/10.
- Ergonomic mango made of cast stainless steel.
- Natural and ecological. Free of toxic and heavy materials.
- Thermo Fund diffuser sandwich, rapid and homogeneous distribution of heat.
- Maximum guarantee in terms of resistance, durability and hygiene.
- Internal and exterior finish satin.



**Sartén Foodie**  
Poêle · Pfanne  
Frying pan · Sertä

Ref	€	Ø (cm)	Ød (cm)	h(cm)	e (mm)	U.Venta
45420	28,10	20	13,5	5,5	0,6	1
45422	29,90	22	14,5	5,5	0,6	1
45424	33,50	24	17,5	6,0	0,6	1
45426	35,60	26	19,0	6,0	0,6	1
45428	39,40	28	19,5	6,5	0,6	1
45430	40,60	30	22,0	6,5	0,6	1



**Sartén antiadherente Foodie**  
Poêle antiadherent · Pfanne, Antihäft  
Frying-pan, non-stick · Sertä anti-aderente

Ref	€	Ø (cm)	Ød (cm)	h(cm)	e (mm)	U.Venta
45320	33,10	20	13,5	5,5	0,6	1
45322	34,30	22	14,5	5,5	0,6	1
45324	40,50	24	17,5	6,0	0,6	1
45326	41,50	26	19,0	6,0	0,6	1
45328	48,50	28	19,5	6,5	0,6	1
45330	49,60	30	22,0	6,5	0,6	1



**Wok**  
Wok · Wok  
Wok · Wok

Ref	€	Ø (cm)	Ød (cm)	h(cm)	U.Venta
45828	40,00	28	15,6	8,0	1



**Wok antiadherente**  
Wok antiadherent · Wok, Antihäft  
Wok, non-stick · Wok anti-aderenter

Ref	€	Ø (cm)	Ød (cm)	h(cm)	U.Venta
45728	48,20	28	15,6	8,0	1



**Crepera**  
Crepierre · Crêpes-Pfanne  
Crepiere · Crepeira

Ref	€	Ø (cm)	Ød (cm)	h(cm)	U.Venta
45829	39,50	28	24	1,8	1



**Crepera antiadherente**  
Crepierre antiadherent · Crêpes-Pfanne, Antihäft  
Crepiere, non-stick · Crepeira anti-aderenter

Ref	€	Ø (cm)	Ød (cm)	h(cm)	U.Venta
45729	42,30	28	24	1,8	1



# Sartenes Origin

INOX 18/10



- Fabricada en acero inoxidable 18/10 de la mejor calidad.
- Mango fabricado en acero inoxidable con recubrimiento PVD (proceso de chapado iónico con titanio, metal de gran dureza).
- Máxima garantía en cuanto a resistencia, durabilidad e higiene.
- Fondo termodifusor sandwich (inox 18/10 - aluminio - inoxidable).
- Distribución rápida y uniforme del calor.

- Fabriquées en acier inoxydable 18/10 de la meilleure qualité.
- Poignée en acier inoxydable avec revêtement PVD (procédé de placage ionique avec du titane, métal de haute dureté).
- Garantie maximale en termes de résistance, de durabilité et d'hygiène.
- Fond thermodiffuseur sandwich (Inox 18/10 - Aluminium - Inoxydable)
- Distribution rapide et uniforme de la chaleur.

- Made of the highest quality 18/10 stainless steel.
- Handle made of stainless steel with PVD coating (ionic plating process with titanium, high hardness metal).
- Maximum guarantee in terms of resistance, durability and hygiene.
- Heat-diffusing sandwiched base (18/10 stainless steel - aluminium - st. Steel)
- Quick and even heat distribution..

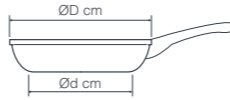

## Sartén Origin

Poêle · Pflanne  
Frying pan · Sertã

Ref	€	Ø (cm)	Ød (cm)	h(cm)	e (mm)	U.Venta
47318	25,00	18	12,5	4,00	0,6	1
47320	27,80	20	12,5	4,20	0,6	1
47322	30,00	22	16,8	4,40	0,6	1
47324	31,90	24	18,5	4,60	0,6	1
47328	35,70	28	21,2	4,80	0,6	1
47330	38,80	30	23,0	5,00	0,6	1

## Sartén antiadherente Origin

Poêle antiadherent · Pflanne, Antihafit  
Frying-pan, non-stick · Sertã anti-aderente

Ref	€	Ø (cm)	Ød (cm)	h(cm)	e (mm)	U.Venta
47418	29,60	18	12,5	4,00	0,6	1
47420	32,80	20	12,5	4,20	0,6	1
47422	35,20	22	16,8	4,40	0,6	1
47424	37,50	24	18,5	4,60	0,6	1
47428	42,50	28	21,2	4,80	0,6	1
47430	46,30	30	23,0	5,00	0,6	1

# Sartenes Cuisine

INOX 18/10



- Fabricadas en acero inoxidable 18/10 de máxima calidad.
- Mango ergonómico de acero inoxidable.
- Máxima garantía en resistencia, durabilidad e higiene.
- Distribución rápida y uniforme del calor gracias a su fondo FULL INDUCTION.

- Fabriqué en acier inoxydable 18/10 de la plus haute qualité.
- Poignée ergonomique en acier inoxydable.
- Garantie maximale de résistance, durabilité et d'hygiène.
- Diffusion rapide et uniforme de la chaleur grâce à son fond à INDUCTION TOTALE.

- Made of the highest quality 18/10 stainless steel quality.
- Ergonomic stainless steel handle.
- Maximum guarantee of resistance, durability and hygiene.
- Fast and uniform heat distribution thanks to its FULL INDUCTION bottom.

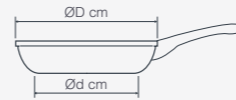

new



## Sartenes Cuisine

Poêle · Pflanne  
Frying pans · Sertã

Ref	€	Ø (cm)	Ød (cm)	h(cm)	e (mm)	U.Venta
44420	24,30	20	13,5	5,0	0,5	1
44424	29,10	24	17,5	6,0	0,5	1
44428	33,90	28	19,5	6,5	0,5	1

## Sartén antiadherente Cuisine

Poêle antiadherent · Pflanne, Antihafit  
Frying-pan, non-stick · Sertã anti-aderente

Ref	€	Ø (cm)	Ød (cm)	h(cm)	e (mm)	U.Venta
44320	27,90	20	13,5	5,0	0,5	1
44324	34,50	24	17,5	6,0	0,5	1
44328	41,60	28	19,5	6,5	0,5	1



# Paelleras

## Paella pans

# Paelleras Inoxidables

INOX  
18/10



## Paellera con tapa Chef Luxe

Plat rond avec couvercle · Pfanne mit Deckel  
Round dish with lid · Paelheira com tampa

Ref	€	Ø (cm)	h(cm)	e (mm)	L	U.Venta
54636	174,10	36	7,0	1,5	7,00	1
54640	211,90	40	8,0	1,5	10,00	1
54645	245,40	45	8,5	2,0	12,00	1
* 54650	309,70	50	9,0	2,0	17,00	1

\* NO inducción · NON induction · NOT Induction



## Paellera con tapa Chef Classic

Plat rond a/couvercle · Pfanne mit Deckel  
Round with lid · Paelheira com tampa

Ref	€	Ø (cm)	h(cm)	e (mm)	L	U.Venta
50624	64,80	24	6,0	0,8	2,70	1
50628	87,70	28	6,0	0,8	3,60	1
50632	113,20	32	6,0	0,8	5,00	1
50636	143,40	36	7,0	1,0	7,10	1
50640	165,00	40	8,0	1,0	10,00	1
50645	193,80	45	8,5	1,0	13,50	1
50650	251,40	50	9,0	1,0	17,60	1
* 50660	363,40	60	9,0	1,0	25,40	1

\* NO inducción · NON induction · NOT Induction



## Paellera sin tapa Wagner

Plat rond s/couvercle · Pfanne ohne Deckel  
Round dish without lid · Paelheira sem tampa

Ref	€	Ø (cm)	h (cm)	e (mm)	L	U.Venta
50624W	52,10	24	6,0	0,8	2,70	1
50628W	69,10	28	6,0	0,8	3,60	1
50632W	85,80	32	6,0	0,8	5,00	1
50636W	116,60	36	7,0	1,0	7,10	1
50640W	133,40	40	8,0	1,0	10,00	1
50645W	153,60	45	8,5	1,0	13,50	1
50650W	207,70	50	9,0	1,0	17,60	1
* 50660W	295,90	60	9,0	1,0	25,40	1

\* NO inducción · NON induction · NOT Induction



## Paellera sin tapa Chef Luxe

Plat rond s/couvercle · Pfanne ohne Deckel  
Round dish without lid · Paelheira sem tampa

Ref	€	Ø (cm)	U.Venta
54636S	137,80	36	1
54640S	170,80	40	1
54645S	198,30	45	1
* 54650S	253,50	50	1

\* NO inducción · NON induction · NOT Induction



## Paellera sin tapa Chef Classic

Plat rond s/couvercle · Pfanne ohne Deckel  
Round dish without lid · Paelheira sem tampa

Ref	€	Ø (cm)	U.Venta
50624S	49,60	24	1
50628S	70,30	28	1
50632S	90,20	32	1
50636S	115,60	36	1
50640S	133,80	40	1
50645S	156,50	45	1
50650S	205,60	50	1
* 50660S	303,60	60	1

\* NO inducción · NON induction · NOT Induction



## Paellera sin tapa Eco Chef

Plat rond sans couvercle · Pfanne ohne Deckel  
Round without lid · Paelheira sem tampa

Ref	€	Ø (cm)	h(cm)	e (mm)	L	U.Venta
57624	38,70	24	6,5	0,7	3,00	1
57628	53,60	28	6,5	0,7	4,00	1
57632	68,50	32	7,0	0,7	5,00	1
57636	94,30	36	7,0	0,9	7,10	1
57640	108,70	40	8,0	0,9	10,00	1



## Paellera Valenciana

Plat à paella · Paellapfanne  
Round dish for paella · Paelheira valenciana

Ref	€	Ø (cm)	h(cm)	Raciones	e (mm)	U.Venta
60130	63,50	30	4,1	4	0,6	1
60134	76,40	34	4,1	6	0,6	1
60138	90,90	38	4,2	8	0,6	1
60142	111,10	42	4,5	10	0,6	1
60146	132,00	46	4,6	12	0,7	1
60150	170,90	50	4,8	14	0,7	1
60155	217,60	55	5,2	16	0,8	1
60160	270,50	60	4,9	18	0,8	1



## Paellera Valenciana antiadherente

Plat à paella anti-adhésif · Paellapfanne, Antihaf  
Round dish for paella non-stick · Paelheira valenciana anti-aderente

Ref	€	Ø (cm)	Raciones	U.Venta
60232	79,10	32	5	1
60236	93,50	36	7	1
60240	113,00	40	9	1

- 1.- Acero inoxidable 18/10 · 18/10 stainless steel
- 2.- Aluminio · Aluminium
- 3.- Acero inoxidable inducción · Induction stainless steel

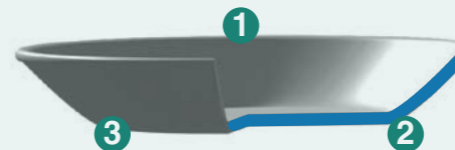

- El aluminio interior garantiza una distribución rápida y uniforme del calor, así como un importante ahorro en el uso de la energía.
- Asas ergonómicas fabricadas en fundición de acero inoxidable 18/10 de gran calidad.
- Aptas para todo tipo de cocinas, especialmente para la inducción.
- Máxima garantía en cuanto a resistencia, durabilidad e higiene.
- Aptas para el horno (hasta 260°C) y lavavajillas.

- The aluminium layer inside ensures fast, even heat distribution to the food and significant energy saving costs.
- Ergonomic handles made of high quality 18/10 cast stainless steel.
- Suitable for all hobs, especially induction.
- Maximum guarantee in terms of strength, durability and hygiene.
- Oven (up to 260°) and dishwasher safe.

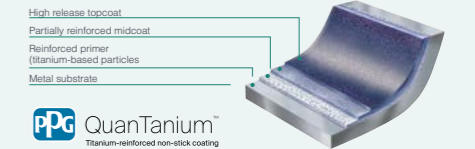

- Antiadherente QuanTanium® reforzado con partículas de titanio; libre de materiales tóxicos y pesados, ecológico y libre de PFOA
- Antiadhésif QuanTanium® renforcé avec des particules de titane sans matériaux toxiques ni métaux lourds, écologique et sans PFOA.
- QuanTanium® non-stick reinforced with titanium particles; free from toxic and heavy materials, environmentally friendly and PFOA-free.



## Paellera TriChef

Plat à paella · Pfanne  
Round dish · Paelheira

Ref	€	Ø (cm)	Ød (cm)	h(cm)	Raciones	U.Venta
60834	44,70	34	25	5,0	5	1
60840	56,10	40	30	6,0	6	1



## Paellera TriChef antiadherente

Plat à paella, antiadhésive · Paellapfanne, Antihaf  
Round dish for paella, non stick · Paelheira anti-aderente

Ref	€	Ø (cm)	Ød (cm)	h(cm)	Raciones	U.Venta
60833	57,90	34	25	5,0	5	1
60839	73,20	40	30	6,0	6	1

# Paelleras aluminio



- Fabricada en aluminio fundido de gran calidad y espesor.
- Recubrimiento antiadherente TRICapa reforzado con partículas a base de piedra, libre de materiales tóxicos y pesados.
- Ecológico y libre de PFOA.
- Ahorro energético, hasta un 45% más eficiente, gracias a su fondo FULL INDUCTION.
- La base de aluminio permite una distribución homogénea del calor, permitiendo que los alimentos se cocinen rápidamente y de manera uniforme, sin apenas utilizar aceite.
- Diseñada para uso doméstico y rendimiento profesional.
- Máxima resistencia al desgaste.
- Fácil limpieza interior y exterior gracias a su protección antiadherente.
- Compatibilidad: todo tipo de cocinas, incluida la inducción.

- Manufactured in molten aluminum of high quality and thickness.
- Straight -based antiating coating with stone -based particles, free of toxic and heavy materials.
- Ecological and free of PFOA.
- Energy savings, up to 45% more efficient, thanks to its Full Induction fund.
- The aluminum base allows a homogeneous distribution of heat, allowing food to cook quickly and uniformly, with hardly any oil.
- Designed for domestic use and professional performance.
- Maximum wear resistance.
- Easy interior and exterior cleaning thanks to its non -stick protection.
- Compatibility: all types of kitchens, including induction.



## Asas para paellera EcoPiedra

Poignées pour plat rond · Griffschutz for Pfanne  
Handles for round dish · Asas para paellera

Ref	€	Ø (cm)	U.Venta
R25436A	11,90	32-36-40	1

- Fabricada en aluminio fundido.
- Garantiza la absorción y distribución uniforme del calor, sin puntos de sobrecalentamiento.
- La distribución del calor uniforme por toda la pieza hace que los alimentos no pierdan su jugo durante la cocción, conservando así todos sus nutrientes y vitaminas.
- Fondo difusor FULL INDUCTION; asegura un rendimiento óptimo en todo tipo de cocinas con un reparto de calor inmejorable logrando la máxima eficiencia y ahorro de energía.
- Perfecta para arroces, carnes, pescados, legumbres, verduras, guisos, cremas, salsas, sopas, etc.
- Revestimiento antiadherente Xylan Plus.
- Diseño atractivo y funcional.
- Compatible con todo tipo de cocinas, incluida la inducción.

- Manufactured in molten aluminum.
- It guarantees the uniform absorption and distribution of heat, without overheating points.
- The distribution of uniform heat throughout the piece causes food not to lose their juice during cooking, thus retaining all its nutrients and vitamins.
- Full Induction Diffuser Fund; ensures optimal performance in all types of kitchens with an unbeatable heat distribution achieving maximum efficiency and energy saving.
- Perfect for rice, meats, fish, legumes, vegetables, stews, creams, sauces, soups, etc.
- Antiating Coating Xylan Plus.
- Attractive and functional design.
- Compatible with all types of kitchens, including induction.



Ref	€	Ø (cm)	Ød (cm)	h(cm)	e (mm)	Raciones	U.Venta
25932	84,30	32	25,5	4,5	1,6	5	1
25936	98,50	36	29,5	4,5	2,0	7	1
25940	109,50	40	33,5	4,5	2,0	9	1

## Paellera Cocotte

Plat rond · Pfanne  
Round · Paelheira

Ref	€	Ø (cm)	Ød (cm)	h(cm)	e (mm)	Raciones	U.Venta
25932	84,30	32	25,5	4,5	1,6	5	1
25936	98,50	36	29,5	4,5	2,0	7	1
25940	109,50	40	33,5	4,5	2,0	9	1

## Paellera EcoPiedra

Plat à paella · Pfanne  
Round dish · Paelheira

Ref	€	Ø (cm)	Ød (cm)	h(cm)	e (mm)	Raciones	U.Venta
25432	76,50	32	25,5	4,5	1,6	5	1
25436	81,90	36	29,5	4,5	2,0	7	1
25440	95,50	40	33,5	4,5	2,0	9	1

## Paellera Steel Pro

Plat à paella · Paellapfanne  
Round dish for paella · Paelheira

Ref	€	Ø (cm)	h(cm)	Raciones	U.Venta
63621	6,90	20	4,0	1	6
63623	7,00	22	3,5	1	6
63625	7,30	24	3,7	1	6
63627	8,00	26	3,7	2	6
63629	8,30	28	4,1	3	6
63631	9,00	30	4,2	4	6
63633	10,10	32	5,0	5	6
63635	10,90	34	4,6	6	6
63637	11,70	36	5,0	7	1
63639	13,20	38	5,0	8	1
63641	14,30	40	5,0	9	1
63643	16,40	42	5,0	10	1
63647	18,50	46	5,0	12	1
63651	22,00	50	5,5	14	1
63656	36,00	55	5,5	16	1
63661	42,50	60	5,0	19	1
63666	52,70	65	5,5	22	1
63671	75,00	70	6,0	25	1
63681	103,00	80	7,1	40	1
63691	143,90	90	8,0	50	1
63115	429,00	115	9,0	120	1
63130	890,80	130	12,0	200	1

4 asas  
4 handles  
6 asas  
6 handles

## Paellera Ferrum

Plat à paella · Paellapfanne  
Round dish for paella · Paelheira

Ref	€	Ø (cm)	h(cm)	e (mm)	Raciones	U.Venta
63928	58,70	28	4,5	2,5	3	1
63932	66,50	32	4,7	2,5	5	1
63936	82,90	36	5,5	2,5	7	1
63940	91,30	40	5,5	2,5	9	1

## Paellera Chef aluminio

Plat rond · Pfanne  
Round · Paelheira

Ref	€	Ø (cm)	h(cm)	e (mm)	L	U.Venta
20628	42,90	28	7,0	2,5	4,30	1
20630	45,60	30	6,5	2,5	4,75	1
20632	48,80	32	7,0	2,5	5,50	1
20634	51,60	34	7,0	2,5	6,35	1
20636	54,50	36	7,5	2,5	7,45	1
20638	55,40	38	7,5	3,0	8,60	1
20640	65,10	40	8,0	3,0	10,05	1
20645	71,20	45	8,0	3,0	12,50	1
20650	83,00	50	8,0	3,0	15,50	1
20660	118,70	60	10,0	3,5	28,00	1

# Paelleras Master

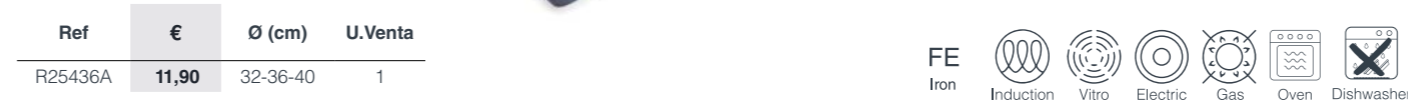

- Fabricada en aluminio fundido.
- Garantiza la absorción y distribución uniforme del calor, sin puntos de sobrecalentamiento.
- La distribución del calor uniforme por toda la pieza hace que los alimentos no pierdan su jugo durante la cocción, conservando así todos sus nutrientes y vitaminas.
- Fondo difusor FULL INDUCTION; asegura un rendimiento óptimo en todo tipo de cocinas con un reparto de calor inmejorable logrando la máxima eficiencia y ahorro de energía.
- Perfecta para arroces, carnes, pescados, legumbres, verduras, guisos, cremas, salsas, sopas, etc.
- Revestimiento antiadherente Xylan Plus.
- Diseño atractivo y funcional.
- Compatible con todo tipo de cocinas, incluida la inducción.

- Manufactured in molten aluminum.
- It guarantees the uniform absorption and distribution of heat, without overheating points.
- The distribution of uniform heat throughout the piece causes food not to lose their juice during cooking, thus retaining all its nutrients and vitamins.
- Full Induction Diffuser Fund; ensures optimal performance in all types of kitchens with an unbeatable heat distribution achieving maximum efficiency and energy saving.
- Perfect for rice, meats, fish, legumes, vegetables, stews, creams, sauces, soups, etc.
- Antiating Coating Xylan Plus.
- Attractive and functional design.
- Compatible with all types of kitchens, including induction.



Ref	€	Ø (cm)	Ød (cm)	h(cm)	e (mm)	Raciones	U.Venta
63928	58,70	28	25,5	4,5	2,5	3	1
63932	66,50	32	29,5	4,7	2,5	5	1
63936	82,90	36	33,5	5,5	2,5	7	1
63940	91,30	40	37,5	5,5	2,5	9	1

## Paellera Steel Pro

Plat à paella · Paellapfanne  
Round dish for paella · Paelheira

Ref	€	Ø (cm)	h(cm)	Raciones	U.Venta
63621	6,90	20	4,0	1	6
63623	7,00	22	3,5	1	6
63625	7,30	24	3,7	1	6
63627	8,00	26	3,7	2	6
63629	8,30	28	4,1	3	6
63631	9,00	30	4,2	4	6
63633	10,10	32	5,0	5	6
63635	10,90	34	4,6	6	6
63637	11,70	36	5,0	7	1
63639	13,20	38	5,0	8	1
63641	14,30	40	5,0	9	1
63643	16,40	42	5,0	10	1
63647	18,50	46	5,0	12	1
63651	22,00	50	5,5	14	1
63656	36,00	55	5,5	16	1
63661	42,50	60	5,0	19	1
63666	52,70	65	5,5	22	1
63671	75,00	70	6,0	25	1
63681	103,00	80	7,1	40	1
63691	143,90	90	8,0	50	1
63115	429,00	115	9,0	120	1
63130	890,80	130	12,0	200	1

4 asas  
4 handles  
6 asas  
6 handles

## Paellera Ferrum

Plat à paella · Paellapfanne  
Round dish for paella · Paelheira

Ref	€	Ø (cm)	h(cm)	e (mm)	Raciones	U.Venta
63928	58,70	28	4,5	2,5	3	1
63932	66,50	32	4,7	2,5	5	1
63936	82,90	36	5,5	2,5	7	1
63940	91,30	40	5,5	2,5	9	1

## Paellera Steel Pro

Plat à paella · Paellapfanne  
Round dish for paella · Paelheira

Ref	€	Ø (cm)	h(cm)	Raciones	U.Venta
63621	6,90	20	4,0	1	6
63623	7,00	22	3,5	1	6
63625	7,30	24	3,7	1	6
63627	8,00	26	3,7	2	6
63629	8,30	28	4,1	3	6
63631	9,00	30	4,2	4	6
63633	10,10	32	5,0	5	6
63635	10,90	34	4,6	6	6
63637	11,70	36	5,0	7	1
63639	13,20	38	5,0	8	1
63641	14,30	40	5,0	9	1
63643	16,40	42	5,0	10	1
63647	18,50	46	5,0	12	1
63651	22,00	50	5,5	14	1
63656	36,00	55	5,5	16	1
63661	42,50	60	5,0	19	1
63666	52,70	65	5,5	22	1
63671	75,00	70	6,0	25	1
63681	103,00	80	7,1	40	1
63691	143,90	90	8,0	50	1
63115	429,00	115	9,0	120	1
63130	890,80	130	12,0	200	1

4 asas  
4 handles  
6 asas  
6 handles

## Paellera Ferrum

Plat à paella · Paellapfanne  
Round dish for paella · Paelheira

Ref	€	Ø (cm)	h(cm)	e (mm)	Raciones	U.Venta
63928	58,70	28	4,5	2,5	3	1
63932	66,50	32	4,7	2,5	5	1
63936	82,90	36	5,5	2,5	7	1
63940	91,30	40	5,5	2,5	9	1

## Paellera Steel Pro

Plat à paella · Paellapfanne  
Round dish for paella · Paelheira

Ref	€	Ø (cm)	h(cm)	Raciones	U.Venta
63621	6,90	20	4,0	1	6
63623	7,00	22	3,5	1	6
63625	7,30	24	3,7	1	6
63627	8,00	26	3,7	2	6
63629	8,30	28	4,1	3	6
63631	9,00	30	4,2	4	6
63633	10,10	32	5,0	5	6
63635	10,90	34	4,6	6	6
63637	11,70	36	5,0	7	1
63639	13,20	38	5,0	8	1
63641	14,30	40	5,0	9	1
63643	16,40	42	5,0	10	1
63647	18,50	46	5,0	12	1
63651	22,00	50	5,5	14	1
63656	36,00	55	5,5	16	1
63661	42,50	60	5,0	19	1
63666	52,70	65	5,5	22	1
63671	75,00	70	6,0	25	1
63681	103,00	80	7,1	40	1
63691	143,90	90	8,0	50	1
63115	4				



### Paellera antiadherente Steel

Plat à paella, antiadhesive · Paellapfanne, Antihaft  
Round dish for paella, non stick · Paelheira anti-aderente

Ref	€	Ø (cm)	Raciones	U.Venta
60127	22,40	28	3	1
60131	25,30	32	5	1
60135	29,30	36	7	1
60139	32,90	40	9	1
60144	43,90	45	12	1
60149	53,00	50	14	1
60159	67,20	60	19	1



Esmalte vitrificado  
Vitrified enamel

### Paellera Smalt

Plat à paella · Paellapfanne, emailliert  
Round dish for paelle · Paelheira esmaltada

Ref	€	Ø (cm)	Raciones	U.Venta
60170	5,20	10	1	1
60172	5,90	12	1	1
60175	6,90	15	1	1
60180	8,80	20	1	1
60184	10,70	24	1	1
60188	13,00	28	3	1
60182	17,90	32	5	1
60186	20,00	36	7	1
60141	24,70	40	9	1
60151	37,80	50	14	1
60161	59,50	60	19	1

## Accesorios para paelleras

Diseñado para el soporte paellero ref.: 63700  
Designed for base for burner



### Paellero Gas Butano

Rechaud · Brenner  
Burner · Paelheira gás butanos

Ref	€	Ø (cm)	W	Presión	Quemadores	U.Venta	Paelleras recomendadas
63731	48,00	30	6500	37	1	1	Ø36-38-40-42-46
63741	83,00	20-40	11400	37	2	1	Ø28-30-32-34-36-46-50-55
63751	109,70	30-50	14100	37	2	1	Ø38-40-42-46-60-65-70
63761	154,50	20-40-60	21000	37	3	1	Ø28-30-32-34-36-46-50-55-70-80
63771	254,00	30-50-70	24500	37	3	1	Ø38-40-42-46-60-65-70-80-90

Regulable para distintas medidas  
Adjustable for different measures



### Soporte paellero

Pied pour rechaud · Stände für Brenner  
Base for burner · Cuporte paelheria

Ref	€	Ø (cm)	h(cm)	U.Venta
63700	47,60	Hasta 60	70	1

Válido para propano y butano · NO válidas Gas Natural y Gas Ciudad  
Valid for propane and butane · NOT valid Natural Gas and Gas City

# Rustideras / Horno

## Roasting pans / Oven







# Inox 18/10



- Gran calidad, resistencia, tamaño y capacidad, muy útiles en la cocina.
- Ideales para la cocción de platos y asados al horno.
- Soportan sin problemas temperaturas altas.
- Excelente resistencia a la corrosión y a los ácidos alimentarios y sales.
- Asas atérmicas.

- Grande qualité, robustesse, taille et capacité, très utiles dans la cuisine.
- Idéal pour la cuisson de plats et de rôtis au four.
- Supporte sans problèmes des températures élevées.
- Excellente résistance à la corrosion et aux sels et acides alimentaires.
- Poignées athermiques.

- Great quality, durability, size and capacity, very useful in the kitchen.
- Ideal for cooking dishes and roasts in the oven.
- Easily withstands high temperatures.
- Excellent resistance to corrosion and to food acids and salts.
- Heat-resistant handles.



## Rustidera Inox

Plat à rotir · Lasagneform  
Roaster · Assadeira

Ref	€	cm	L	h(cm)	e (mm)	U.Venta
62530	33,70	30x21	3,4	5,5	0,7	1
62535	44,50	35x26	5,0	5,5	0,7	1
62540	56,60	40x31	7,4	6,0	0,8	1



## Rustidera Chef Inox

Couvercle · Deckel  
Lid · Tampa

Ref	€	cm	h(cm)	e (mm)	U.Venta
50540	118,40	40x30	8,0	1,0	1
50550	156,80	50x40	8,0	1,0	1
50560	197,50	60x45	8,0	1,0	1
50570	225,60	70x45	9,5	1,0	1



INOX

## Rustidera asas abatibles

Plat à gratin anse tombante · Bratpfanne mit Fallgriffen  
Roaster moving handles · Assadeira asa abatível

Ref	€	cm	h(cm)	e (mm)	L	U.Venta
61530	16,30	30x22	5,0	0,5	3,3	1
61535	20,70	35x26	6,0	0,6	4,8	1
61540	26,50	40x28	6,5	0,7	6,2	1
61545	39,20	45x32	7,5	0,8	10,8	1
61550	73,00	50x36	8,0	0,8	15,3	1



## Rustidera honda asas abatibles

Plat à rotir anse tombante · Bratpfanne mit Fallgriffen  
Roaster moving handles · Assadeira funda asa abatível

Ref	€	cm	h(cm)	e (mm)	L	U.Venta
62530A	37,30	30x22	7,5	0,7	4,9	1
62535A	45,40	35x26	8,0	0,7	7,0	1
62540A	54,00	40x28	8,0	0,7	9,5	1
62545A	62,70	45x32	9,0	0,8	12,9	1



INOX

## Bandeja con rejilla Essential

Plat à four avec grille · Backblech mit Gitter  
Tray with rack · Bandeja com grelha



Rejilla extraíble  
Removable rack

Ref	€	cm	h(cm)	U.Venta
15562	10,20	21,5x15	2,0	1
15563	12,60	23,5x15,5	2,5	1
15566	15,50	26,5x20,5	2,5	1
15567	25,70	40,5x30,5	2,5	1

- Bandeja con rejilla extraíble fabricada en acero inoxidable de gran calidad.
- Borde de acero encapsulado reforzado que evita la deformación.
- Alta conductividad térmica: distribuye el calor de manera uniforme proporcionando resultados de cocción óptimos.
- Funcional y versátil: Con la rejilla podrás asar todo tipo de carnes, enfriar galletas, deshidratar frutas, etc. Sin la rejilla, podrás estofar guisos, asar todo tipo de verduras incluso hornear tu bizcocho favorito.
- Apta para el horno, frigorífico y congelador.

- High quality stainless steel tray with removable rack.
- Reinforced encapsulated steel rim to prevent warping.
- High thermal conductivity for even heat distribution and optimum cooking results.
- Highly functional and versatile: use the rack to roast all kinds of meat, to cool biscuits, dehydrate fruit, etc., or remove it to make casseroles, roast all kinds of vegetables and even bake your own favourite sponge cake!
- Oven, fridge and freezer safe.

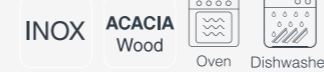
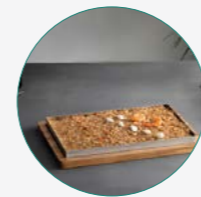
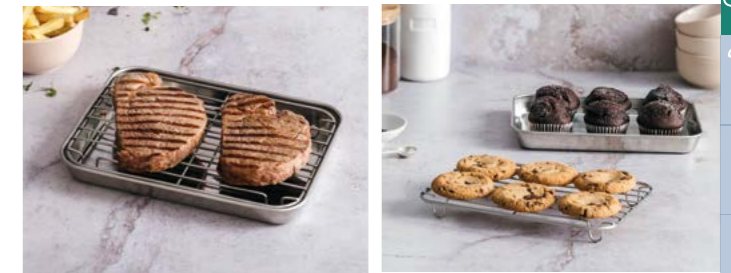

## Llauna de arroz

Plateau de présentation du riz · Reisblech  
Stainless steel rice tray · Bandeja para arroz

Ref	€	cm	h(cm)	U.Venta
60830	28,20	33x23	3,0	1

- Compuesta por una bandeja de acero inoxidable de gran calidad y base de madera de acacia.
- La bandeja está diseñada para cocinar al horno y barbacoas todo tipo de arroces, guisos, carnes y pescados.
- La base de madera de acacia es perfecta para resaltar las presentaciones en la mesa.
- Medidas de llauna: 29,5x19,5x2 cm
- Medidas base de madera: 33x23x1,7 cm (No apta para el horno y lavavajillas).
- Medidas totales: 33x23x3 cm.

- Composé d'un plateau en acier inoxydable de haute qualité et d'une base en bois d'acacia.
- Le plateau est conçu pour la cuisson au four et au barbecue de tous les types de riz, de ragoûts, de plats de viande et de poisson.
- La base en bois d'acacia est parfaite pour mettre en valeur les présentations sur la table.
- Dimensions de riz plateau : 29,5x19,5x2 cm.
- Dimensions de la base en bois : 33x23x1,7 cm (ne va pas au four ni au lave-vaisselle).
- Dimensions totales : 33x23x3 cm.

- Composed of a high quality stainless steel tray and acacia wood base.
- The tray is designed for baking and barbecuing all types of rice, stews, meat and fish dishes.
- The acacia wood base is perfect for highlighting presentations on the table.
- Measurements of rice llauna: 29,5x19,5x2 cm.
- Wooden base dimensions: 33x23x1,7 cm (not oven and dishwasher safe).
- Total dimensions: 33x23x3 cm



# Aluminio



- **Distribución homogénea del calor por toda la superficie.**
- **Recubrimiento antiadherente de gran calidad, resistente a arañazos y ralladuras.**
- **Ecológico, libre de materiales tóxicos y pesados. Libre de PFOA.**
- **Robustos y resistentes a las deformaciones y a la abrasión.**
- **Ideal para hornear y gratinar todo tipo de alimentos.**
- **Asas diseñadas para un agarre seguro y cómodo.**

- Distribution homogène de la chaleur sur toute la surface.
- Revêtement antiadhésif de grande qualité, résistant aux rayures.
- Écologique, sans matériaux toxiques ni métaux lourds. Sans PFOA.
- Robuste et résistant à la déformation et à l'abrasion.
- Idéal pour une utilisation au four et pour gratiner tout type d'aliments.
- Poignées conçues pour une prise en mains sûre et pratique.

- Heat is distributed evenly over the entire surface.
- It has a high quality non-stick coating that is scratch and scrape resistant.
- It's environmentally friendly and free of toxic materials and heavy metals. It's PFOA free.
- The inside and outside have a matte black finish.
- It's sturdy and resists warping and scratches.
- It's perfect for baking and cooking all kinds of foods.
- The handles are designed for a safe and comfortable grip.

Asa de tubo de acero inoxidable 18/10  
Handles in a 18/10 stainless steel tube



## Rustidera con asas fijas

Plat à rotir anse fixe · Bratpfanne, m. feststehenden Griffen  
Roaster fix handle · Assadeira com asa fixa

Ref	€	cm	h(cm)	e (mm)	L	U.Venta
20540F	55,40	40x30	6,2	2,5	7,45	1
20545F	59,40	45x32	6,2	2,5	10,40	1
20550F	74,60	50x35	7,0	3,0	12,60	1
20555F	81,00	55x37	7,7	3,0	16,30	1
20560F	87,60	60x40	7,7	3,0	18,95	1
20565F	97,40	65x43	7,9	3,0	24,30	1
20570F	103,00	70x45	9,0	3,0	28,65	1

## Rustidera con asas abatibles

Plat à rotir anse tombante · Bratpfanne mit Fallgriffen  
Roaster moving handle · Assadeira com asa abatível

Ref	€	cm	h(cm)	e (mm)	L	U.Venta
20540A	55,40	40x30	6,2	2,5	7,45	1
20545A	59,40	45x32	6,2	2,5	10,40	1
20550A	74,60	50x35	7,0	3,0	12,60	1
20555A	81,00	55x37	7,7	3,0	16,30	1
20560A	87,00	60x40	7,7	3,0	18,95	1
20565A	97,40	65x43	7,9	3,0	24,30	1
20570A	103,00	70x45	9,0	3,0	28,65	1

**Full Induction**  
TOTAL



## Rustidera aluminio fundido antiderente

Plat à gratin en aluminium fondu, antiadherent · Bratpfanne, Aluminium, Antihaft  
Aluminium cast roaster, non-stick · Assadeira alumínio fundido anti-aderente

Ref	€	cm	h(cm)	U.Venta
25534	62,00	34x28	8,0	1



\* Para la rustidera 25534 · For the 25534 roaster

## Tapa de cristal rustidera

Couvercle en verre pour plat à rôtir · Deckel Glas für Bratpfanne  
Lid glass for roaster · Tampa de vidro para assadeira

Ref	€	cm	h(cm)	U.Venta
25539	15,00	34x28	8	1



## Rustidera Intense

Couvercle · Deckel  
Lid · Tampa

Ref	€	cm	h(cm)	e (mm)	L	U.Venta
15720	14,60	20x15	4,7	1,50	1,2	1
15725	17,40	25x19	5,0	2	2,0	1
15730	23,40	30x22	5,7	3	3,1	1
15735	31,60	35x26	6,3	4,50	4,7	1



AL  
Aluminium

## Bandeja Master

Plateau · Platte  
Tray · Bandeja

Ref	€	cm	h(cm)	U.Venta
68465	23,70	45x33	5,0	1
68466	24,80	53x38	2,5	1



## Rustidera Robust

Plat à rotir a/tombante, antiadherent · Bratpfanne mit Fallgriffen, Aluminium, Antihaft  
Roaster Robust moving handle, non-stick · Assadeira c/asa abatível anti-aderente

Ref	€	cm	h(cm)	U.Venta
23540A	63,30	40x30	6,2	1
23550A	77,00	50x35	7,0	1

- **Calidad premium: fabricadas en aluminio natural; 99,5% de pureza.**
- **Garantizan una conductividad térmica superior, con una distribución homogénea del calor permitiendo así que todas las elaboraciones se doren y se horneen de forma uniforme.**
- **Especialmente diseñadas para profesionales de la repostería, cocinas exigentes y de alta producción.**
- **Ligeras, resistentes e indeformables, fácil manejo.**
- **Limpieza: Se recomienda lavarlas a mano con un jabón y una esponja no abrasivos. No aptas para el lavavajillas.**
- **Consejos de uso: se recomienda usar tanto papel / tapete para hornear.**

- Qualité premium : Fabriqué en aluminium naturel ; 99,5% de pureté.
- Garantit une conductivité thermique supérieure avec une distribution homogène de la chaleur, permettant ainsi à toutes les préparations culinaires de dorer et cuire de façon uniforme.
- Spécialement conçu pour les professionnels de la pâtisserie, les cuisines exigeantes et de grande production.
- Léger, résistant et indéformable ; facile à manipuler.
- Nettoyage : il est recommandé de le laver à la main avec du savon et une éponge non abrasifs. Ne peut pas aller au lave-vaisselle.
- Conseils d'utilisation : il est recommandé d'utiliser du papier sulfurisé ou un tapis de cuisson pour cuire les aliments.

- Premium quality: made from 99.5% pure natural aluminium.
- Guarantees excellent thermal conductivity and homogeneous heat distribution, allowing all baked goods to brown and bake evenly.
- Specially designed for professional bakers, demanding and busy chefs, high output kitchens.
- Lightweight, robust, non-deformable and easy to handle.
- Cleaning: cleaning by hand with detergent and a non-abrasive sponge is recommended. Not dishwasher safe.
- Instructions for use: baking mats and baking paper are both recommended.

# Parrillas · Placas · Pinzas



Varilla · Rod: Ø2 mm

Varilla · Rod: Ø5 mm

## Parrilla Due

Grille · Gitter, Rost  
Grate · Grelha

Ref	€	cm	h(cm)	U.Venta
68741	30,60	60x40	0,8	1

AL  
Aluminium

## Placa horno antiadherente

Plaque à four aluminium anti-adhésif teflon · Backblech, Aluminium, Teflon  
Teflon non-stick coated oven aluminium tray · Placa forno alumínio anti-aderente

Ref	€	cm	h(cm)	U.Venta
68660	38,20	60x40	1,0	1
68659	34,70	GN 1/1	1,0	1

## Placa horno inox

Plaque à four · Backblech  
Baking sheet · Placa de forno

Ref	€	cm	h(cm)	U.Venta
68740	45,40	60x40	0,8	1
68739	35,10	GN 1/1	0,8	1

SI 200°C  
Silicone Max

## Pinza para bandeja GN

Pince inox pour bac Gastronorm · Zange für GN Behälter  
Tong GN tray · Pinça para forno e bandejas GN

Ref	€	Largo (cm)	U.Venta
A 62989	17,50	20	12
B 62998	17,50	20	12



## Parrilla Tri

Grille · Gitter, Rost  
Grate · Grelha

Ref	€	cm	Medidas Cubeta	U.Venta
66920	55,10	65x53	2/1	1
66921	21,20	53x32,5	1/1	1

FE  
Iron

## Placa horno Black

Plaque à four toile noire · Backblech, Schwarzstahl  
Baking sheet black steel · Placa de forno aço negro

Ref	€	cm	h(cm)	U.Venta
68640	37,60	60x40	0,8	1

AL  
Aluminium

## Placa horno Aluminium

Plaque à four · Backblech  
Baking sheet · Placa de forno

Ref	€	cm	h(cm)	U.Venta
68641	35,60	60x40	0,8	1
68642	28,80	GN 1/1	0,8	1



# Tapetes



- Fabricado en rayón.
- Para bridar, albardar, atar asados y rellenos.
- Con soporte de almacenaje.
- Apto para horno. Temperatura max. 230°C
- Manufactured in Rayón.
- To give up, albardar, tie roasts and fillings.
- With storage support.
- Apt for oven. Max temperature. 230°C

## Cordel cocina

Fil de cuisine · Küchenschnur  
Kitchen string · Fio de cozinha

Ref	€	m	U.Venta
61414	6,20	80	6

Flexible, antiadherente y reutilizable  
Flexible, non-stick and reusable

## Tapete silicona White

Tapis en silicone · Backblech-Auflage Silikon  
Silicone covering · Tapete de silicone

Ref	€	cm	U.Venta
66749	20,80	30x40	1
66731	28,90	60x40	1
66732	21,40	52x32	1



## Láminas antiadherentes

Feuilles antiadhésif · Antihft-Blätter  
Non-stick sheets · Láminas antiaderentes

Ref	€	cm	Unidad	U.Venta
66746	10,10	30x40	3	1

- Incluye · Includes:
- 1.- Tablas de conversión de temperatura (°C / °F)
  - 2.- Peso (gr / oz)
  - 3.- Volumén ml / floz / pt)
  - 4.- Longitud (mm / inch)
  - 5.- Reglas laterales (cm / inch)

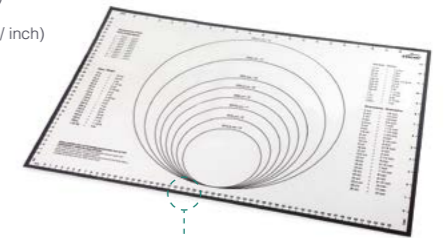

Flexible, antiadherente y reutilizable  
Flexible, non-stick and reusable

## Tapete silicona impreso

Tapis en silicone imprime · Bedruckte Silikonmatte  
Printed silicon mat · Tapete de silicone impreso

Ref	€	cm	U.Venta
66759	29,70	60x40	1

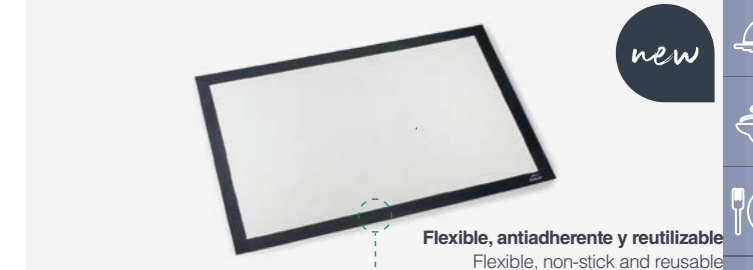

Flexible, antiadherente y reutilizable  
Flexible, non-stick and reusable

## Tapete microperforado White

Tapis microperforé · Mikro-perforierte Matte  
Micro-perforated mat · Tapete microperforado

Ref	€	cm	U.Venta
66794	8,20	30x40	1
66796	15,60	60x40	1
66799	11,10	GN 1/1	1

- Papel de horno para freidora de aire, horno, deshidratador y moldes repostería.
- Hoja de cocción fabricada en fibra de vidrio.
- Reutilizable, más de 1.000 horneados.
- 100% flexible, se adapta a todo tipo de cestillos, moldes, bandejas, etc.
- Antiadherente por ambos lados.
- Medidas: 30x40 cm.
- Soporta temperaturas hasta 250°C.
- Libre de PFOA.

- Air frying, oven, dehydrator and baking paper.
- Cooking sheet manufactured in fibreglass.
- Reusable, more than 1,000 baked.
- 100% flexible, adapts to all types of baskets, molds, trays, etc.
- Uniautor on both sides.
- Measures: 30x40 cm.
- Supports temperatures up to 250°C.
- PFOA free.



## Guantes de cocina



- **Materiales de alta calidad y protección contra el calor por contacto.**
- **Permite manipular todo tipo de utensilios de cocina con total seguridad.**
- **Combina la resistencia al calor con la flexibilidad y comodidad.**
- **Manga que cubre la mayor parte del antebrazo**

- Matériaux de grande qualité et une haute protection contre la chaleur pour contacts.
- Permet de manipuler tout type d'ustensiles de cuisine en toute sécurité.
- Allie la résistance à la chaleur à la flexibilité et le confort.
- Manche qui recouvre une grande partie de l'avant-bras.

- High quality materials and excellent heat protection by contact.
- Lets you handle all kinds of cooking utensils with complete safety.
- Combines heat resistance with flexibility and the comfort.
- The sleeve covers most of your forearm.



- **Exterior: 100% silicona y antebrazo 100% algodón. Interior y forro: 100% poliéster.**
- **Máxima Seguridad: Permite manipular todo tipo de utensilios de cocina con total seguridad.**
- **Gran resistencia a altas temperaturas. Ofrece resistencia al calor por contacto.**
- **Flexibilidad y comodidad. Extralargo; cubre la mayor parte del antebrazo.**
- **Antideslizante: Diseñado para un agarre cómodo y seguro.**
- **Ambidiestro.**
- **Práctica lengüeta para colgarlo en la cocina.**

- Extérieur : 100% silicone et avant-bras : 100% coton. Intérieur et doublure : 100% polyester.
- Sécurité maximale : permet de manipuler tous les types d'ustensiles de cuisine en toute sécurité.
- Haute résistance aux températures élevées. Offre une résistance à la chaleur de contact.
- Flexibilité et confort. Extra long ; couvre la plus grande partie de l'avant-bras.
- Antidérapant : conçu pour une prise en main confortable et sûre.
- Ambidextre.
- Patte pratique pour suspendre dans la cuisine.

- Outer: 100% silicone and forearm 100% cotton. Interior and lining: 100% polyester.
- Maximum safety: Allows handling all types of kitchen utensils in total safety.
- High resistance to high temperatures. Offers resistance to contact heat.
- Flexibility and comfort. Extra long; covers most of the forearm.
- Non-slip: Designed for a comfortable and secure grip.
- Ambidextrous.
- Practical tab for hanging in the kitchen.

### Guante de cocina Vichy

Gant de cuisine · Küchenhandschuh  
Kitchen glove · Luva de cozinha

Ref	€	Largo (cm)	U.Venta
60056	11,30	35	1



### Guante de cocina Safe

Gant de cuisine · Küchenhandschuh  
Kitchen glove · Luva de cozinha

Ref	€	Largo (cm)	U.Venta
61034	10,40	32	6



### Guante de cocina Salve

Gant de cuisine · Küchenhandschuh  
Kitchen glove · Luva de cozinha

Ref	€	Largo (cm)	U.Venta
61033	22,90	33	1



### Guante de cocina Black

Gant de cuisine · Küchenhandschuh  
Kitchen glove · Luva de cozinha

Ref	€	Largo (cm)	U.Venta
60070	12,80	36	1
60073	13,60	43	1



### Guante algodón aluminizado

Gant de cuisine coton aluminisé · Küchehandschuh, Baumwolle, Aluminisierte  
Aluminized cotton oven glove · Luva de cozinha de algodão alumínio

Ref	€	Largo (cm)	U.Venta
61024	6,20	24	1
61030	7,30	30	1
61036	7,90	36	1



2 pcs

### Guante de cocina Universal

Gant de cuisine · Küchenhandschuh  
Kitchen glove · Luva de cozinha

Ref	€	cm	U.Venta
A 60062	35,60	32	1
B 60068	38,70	48	1

- **Capa de algodón 100% adicional en el interior que aumenta la comodidad y la durabilidad**
- Additional 100% cotton layer inside. Provides comfort and durability



### Guante de cocina Red

Gant de cuisine · Küchenhandschuh  
Kitchen glove · Luva de cozinha

Ref	€	cm	U.Venta
60034	13,20	27	1

- **No utilizar por separado**
- Do not use the glove separately



### Guante de cocina Orka Tex

Gant de cuisine · Küchenhandschuh  
Kitchen glove · Luva de cozinha

Ref	€	Largo (cm)	U.Venta
60041	32,00	29	12



### Guante de cocina Orka

Gant de cuisine · Küchenhandschuh  
Kitchen glove · Luva de cozinha

Ref	€	Largo (cm)	U.Venta
60010	38,10	29	1
60011	62,50	42	1

# Protectores



- Mango protector de silicona de alta calidad para sartenes.
- Fácil de colocar, se ajusta perfectamente al mango de la sartén.
- Antideslizante y termorresistente, protege de las temperaturas elevadas.
- Compatible con nuestras sartenes Robust, Ferrum, Dynamic y Tricapa Plus (Ø16-32).

- High quality silicone protector mango for pans.
- Easy to place, it fits perfectly to the mango of the pan.
- Non-slip and thermor resistant, protects from high temperatures.
- Compatible with our Robust, Ferrum, Dynamic and Tricapa Plus (Ø16-32).

## Protector de silicona

Protection en silicone · Silikonschutz  
Silicone handle cover · Protector de silicona

Ref	€	Largo (cm)	U.Venta
23900	6,60	13,5	1



## Manopla de silicona

Mouffette en silicone · Fäustling aus Silikon  
Silicone mitten · Pegas de silicone

Ref	€	U.Venta
60014	10,20	6



## Cubre asas Eco Piedra

Poignées pour plat rond · Griffschutz for Pfanne  
Handles for round dish · Asas para paelheira

Ref	€	Ø (cm)	U.Venta
R25436A	11,90	32-36-40	1



## Cubre asas Titanium

Poignées · Griffchutz, Silikon  
Handles · Asas

Ref	€	Ø (cm)	U.Venta
R27520A	4,40	20	1
R27528A	4,50	24-28	1
R27732A	5,60	32-36	1



## Cubre asas Cocotte

Mouffettes en silicone · Griffchutz aus Silikon  
Silicone mitten · Pegas de silicone

Ref	€	Ø (cm)	U.Venta
R25917G	8,40	16	6
R25933G	8,40	20-24-28-26x20	6
R25935G	8,00	31x25	6

## Asas Red para plancha grill

Poignées pour plaque à Grill · Griffschutz for Platte Grill  
Handles for grill plaque · Asas para plancha Grill

Ref	€	cm	U.Venta
R25536A	4,10	36	1
R25547A	5,70	47	1

## Asas Grey para plancha Grill

Poignées pour plaque à Grill · Griffschutz for Platte Grill  
Handles for grill plaque · Asas para plancha Grill

Ref	€	cm	U.Venta
R25736A	4,10	36	1
R25747A	5,70	47	1



# Paris · Milan · Lima Collection



- Permiten manipular todo tipo de utensilios de cocina con total seguridad.
- Combinan la resistencia al calor con la flexibilidad y comodidad del algodón.
- Guantes con manga que cubre la mayor parte del antebrazo.
- Práctica presilla para colgarlo en la cocina.
- Delantales de gran calidad con bolsillo inferior dividido en dos partes. Unisex. Talla única ajustable.

- Ils permettent de manipuler tous les types d'ustensiles de cuisine en toute sécurité.
- Ils allient la résistance à la chaleur à la souplesse et au confort du coton.
- Gants dont la manche couvre la majeure partie de l'avant-bras.
- Boucle pratique à suspendre dans la cuisine.
- Tabliers de haute qualité avec poche inférieure divisée en deux parties. Unisex. Taille unique réglable.

- For safely handling all types of kitchen utensils.
- Perfectly heat resistant together with the flexibility and comfort of cotton.
- Gloves featuring a sleeve that covers most of the forearm.
- Practical clip for hanging in the kitchen.
- Top-quality aprons featuring a bottom pocket divided into two parts. Unisex. One size fits all (adjustable).



## Colección Paris

Collection · Kollektion  
Collection · Coleção

	Ref	€	cm	U.Venta
A	60080	13,90	68x83	1
B	60037	5,60	30	1
C	60044	4,40	20x20	1

## Colección Milan

Collection · Kollektion  
Collection · Coleção

	Ref	€	cm	U.Venta
A	60081	11,50	68x83	1
B	60038	5,10	30	1
C	60045	4,00	20x20	1

## Colección Lima

Collection · Kollektion  
Collection · Coleção

	Ref	€	cm	U.Venta
A	60082	9,10	68x83	1
B	60039	4,80	30	1
C	60046	3,60	20x20	1

# Protección PRO

**Composición** · Composition:  
62% Polietileno / 62% Polyethylene  
24% Poliéster / 24% Polyester  
14% Fibra de vidrio / 14% Glass fiber



## Guante protección

Gant de protection · Schutzhandschuh  
Protection glove · Luva de protecção

Ref	€	Talla	Medidas	Perímetro mano	Largo (cm)	U.Venta
61101	20,00	M	8	182 mm	24	1
61102	20,00	L	9	192 mm	25	1
61103	20,00	XL	10	204 mm	26	1



NO lavable · NOT washable

EN 388:2016+1:2018



344 XC

CE certificate issued by CTC FRANCE

**Resistencia a la abrasión** 3  
Abrasion resistance

**Resistencia al corte** 4  
Blade cut resistance

**Resistencia al PDM** C  
PDM resistance

**Resistencia al desgarro** 4  
Tear resistance

- Ambidiestros, cómodo y ligero.
- **NO emplear con sierras giratorias o dentadas.**

- Ambidextrous, comfortable and light.
- Do NOT use with rotating or toothed saws.



UNE EN 1082

CE Directive 89/686/EEC and EN 1082-1-1996

- **Guante de cinco dedos con correa en la muñeca.**
- **Reversible para mano derecha como izquierda.**
- **Diseño de correa extraíble y protección completa de mano.**
- **Fácil de lavar y desinfectar.**

- Five fingers with a wrist strap.
- Reversible for right hand as left.
- Extractable belt design and full hand protection.
- Easy to wash and disinfect.

## Ideal para uso en mandolinas profesionales

Ideal for use in professional mandolins

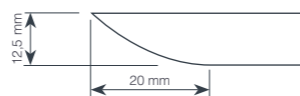

UNE EN 1082

EN ISO 13998: 2003  
NIVEL / LEVEL: 2

- **Ajustable gracias a sus tirantes verticales y horizontales.**
- **Conviene asegurarse de que las medidas del cuchillo empleado no sean inferiores a: 20x12,5mm**

- Adjustable thanks to its vertical and horizontal braces.
- It should be ensured that the measures of the knife used are not less than: 20x12.5mm

INOX

## Guante Cota

Gant en maille · Netz-Handsschuh  
Chainmail glove · Luva de malha

Ref	€	Talla	Medidas	Perímetro mano	Color	U.Venta
39169	142,90	S	7	171 mm	Blanco · White	1
39170	142,90	M	8	182 mm	Rojo · Red	1
39171	142,90	L	9	192 mm	Azul · Blue	1
39172	142,90	XL	10	204 mm	Naranja · Orange	1

INOX

## Delantal cota de malla

Tablier en maille · Kettenhemb Schürze  
Metal butcher's apron · Avental de malha

Ref	€	cm	Perímetro (cm)	U.Venta
39165	331,20	80x55	95-145	1



# Relojes de Cocina



- **Gracias a su parte posterior magnética podrá colocar el reloj de cocina en cualquier parte metálica de su cocina.**
- **Alarma acústica programable.**

- Grâce à sa partie magnétique postérieure, vous pouvez placer l'horloge de cuisine n'importe où dans votre cuisine.
- Alarme acoustique programmable.

- Thanks to its posterior magnetic part you can place the kitchen clock anywhere in your kitchen.
- Programmable acoustic alarm.

IP65

24/12  
Horas  
Hours



## Reloj cocina con alarma

Minuteur de Cuisine avec Alarme · Küchen-Zeitschaltuhr mit Alarm  
Kitchen Timer Alarm · Relógio de cozinha com alarme

Ref	€	cm	U.Venta
60804	40,00	13x24,5x2,5	1



## Reloj digital

Miniuter Électronique · Digitale Küchen-Zeitschaltuhr mit Alarm  
Digital kitchen timer w/alarm · Relógio digital de cozinha com alarme acústico

Ref	€	cm	Programas	U.Venta
60805	9,20	10,5x7	10	1



## Reloj de cocina magnético

Minuteur de cuisine magnétique · Magnetküchentimer  
Magnetic kitchen timer · Relógio de cozinha magnetico

Ref	€	cm	Tiempo	U.Venta
60803	11,10	9,2x3,5	60 min	1

24  
Horas  
Hours



**Soporte plegable.**  
**Potente imán**  
Folding stand.  
Powerful magnet

## Reloj cocina White

Minuteur de Cuisine avec Alarme · Küchen-Zeitschaltuhr mit Alarm  
Kitchen Timer Alarm · Relógio de cozinha com alarme

Ref	€	cm	U.Venta
60802	20,10	7x1,4x5,1	1



# U.P Collection

INOX  
Dishwasher

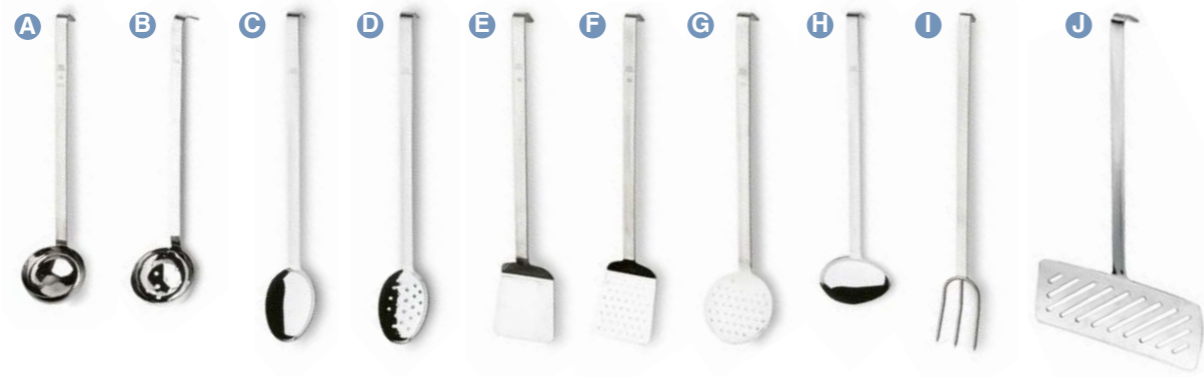

	Ref	€	Ø (cm)	Largo (cm)	L	U.Venta	
A	60306	10,50	6,50	34,5	0,07	6	<b>Cacillo</b> · Louche · Ladle
	60308	12,00	8,00	38,0	0,12	6	
	60309	12,70	9,00	46,0	0,20	6	
	60310	14,40	10,00	46,0	0,25	6	
	60312	16,90	12,00	48,0	0,50	6	
	60314	21,70	14,00	55,0	0,75	6	
B	60316	22,40	16,00	55,5	1,00	6	
	61308	11,30	8	38,0	0,12	6	<b>Cacillo perforado</b> · Louche perforée · Perfored ladle
	61310	14,60	10	46,0	0,25	6	
C	61312	17,40	12	48,0	0,50	1	
	60507	11,30	10,5	48,0	-	1	<b>Cuchara</b> · Cuilliere · Ladle
	60508	13,70	7,50	48,0	-	6	<b>Cuchara perforada</b> · Cuilliere perforee · Perforated ladle
D	61410	12,60	9x10	49,5	-	6	<b>Espátula</b> · Spatule · Spatula
	61412	14,30	11x12	51,0	-	6	
E	61411	13,60	9x10	49,50	-	6	<b>Espátula perforada</b> · Spatule perforee · Perforated spatule
	61413	14,80	11x12	51,0	-	6	
	60408	10,00	8	35,0	-	1	<b>Espumadera</b> · Ecumoire · Skimmer
F	60410	12,00	10	47,0	-	6	
	60412	12,60	12	49,5	-	6	
	60414	16,90	14	57,0	-	6	
	60416	18,50	16	57,0	-	6	
G	60509	14,80	8x10	34,5	0,07	1	<b>Cuchara oblicua</b> · Cuilliere oblique · Crosswire spoon
	60002	15,80	7x8	57,5	2 puntas	6	<b>Tenedor</b> · Fourchette · Fork
H	60003	17,60	7x13	57,5	3 puntas	6	
	62988	20,40	20,5x8	37,0	12	12	<b>Paleta de pescado</b> · Pelle à poisson · Fish turner



## Espumadera alambre Chef Inox

Ecumoire à friture · Fritierlöffel  
Skimmer · Escumadeira arame

Ref	€	Ø (cm)	Largo (cm)	U.Venta
60409	13,20	10	47,0	6
60411	14,30	12	49,0	6
60413	17,20	14	50,5	6
60415	18,90	16	52,0	6
60417	22,30	18	58,0	6
60419	26,60	20	59,0	6
60423	33,60	24	71,5	6
60427	39,30	28	74,0	6

## Espumadera alambre

Ecumoire etamee · Fritierschaufel  
Tinned skimmer · Escumadeira de arame

Ref	€	Ø (cm)	Largo (cm)	U.Venta
63514	12,20	14	54,0	1
63516	13,00	16	56,5	1
63518	13,50	18	56,5	1
63520	16,80	20	67,0	1
63524	18,50	24	70,5	1
63528	21,90	28	76,0	1

**Alambre estañado** · Fil étamé · Tinned wire

## Rasera alambre

Araignée à fil · Fritierlöffel  
Mesh skimmer · Escumadeira arame

Ref	€	Ø (cm)	Largo (cm)	U.Venta
67410	14,30	10	37,0	6
67412	19,40	12	44,0	6
67415	31,10	15	55,5	6
67417	36,30	17	56,0	6
67420	44,50	20	58,0	6

# Buffet Collection

INOX  
18/10  
Dishwasher



	Ref	€	cm	Largo (cm)	U.Venta	
A	72853	11,60	Ø6	24,5	6	<b>Cacillo</b> · Louche · Ladle
B	72857	10,70	5x8	27,5	6	<b>Cuchara</b> · Cuilliere · Ladle
C	72858	10,70	5x8	27,5	6	<b>Cuchara perforada</b> · Cuilliere perforee · Perforated ladle
D	72854	12,90	Ø8	27,0	6	<b>Espumadera</b> · Ecumoire · Skimmer
E	72859	11,60	7x9	28,5	6	<b>Espátula perforada</b> · Spatule perforee · Perforated spatule
F	72850	11,60	5x7,5	23,5	6	<b>Cacillo salsa</b> · Louche sauce · Gravy ladle
G	72851	11,10	6x8,5	28,0	6	<b>Pala ensalada</b> · Pelle à salade · Dalat scoop
H	72856	11,60	6,5x11	31,5	6	<b>Pala pastel</b> · Pelete à gâteau · Cake scoop
I	72855	9,40	4,5x9	28,5	6	<b>Tenedor</b> · Fourchette · Fork

# Profesional Collection

INOX  
18/10  
Dishwasher



	Ref	€	cm	Largo (cm)	U.Venta	
A	72803	21,30	Ø10	37,0	6	<b>Cacillo</b> · Louche · Ladle
B	72807	15,80	7x11	36,0	6	<b>Cuchara</b> · Cuilliere · Ladle
C	72808	16,10	7x11	35,5	6	<b>Cuchara perforada</b> · Cuilliere perforee · Perforated ladle
D	72806	15,30	9x12	39,0	6	<b>Espátula</b> · Spatule · Spatula
E	72809	17,20	9x12	39,0	6	<b>Espátula perforada</b> · Spatule perforee · Perforated spatule
F	72804	17,70	Ø11	37,0	6	<b>Espumadera</b> · Ecumoire · Skimmer
G	72805	14,40	3x10	35,5	6	<b>Tenedor</b> · Fourchette · Fork
H	72810	16,00	Ø6,5	29,0	6	<b>Cacillo salsa</b> · Louche sauce · Gravy ladle
I	72811	16,50	6,5x9	34,0	6	<b>Servidor espaguetis</b> · Cuilliere à spaguetis · Spaguetti server



# Super Monoblock

INOX 18/10  
Dishwasher



	Ref	€	cm	Largo (cm)	U.Venta	
A	62603	17,30	Ø10	31,0	6	<b>Cacillo</b> · Louche · Ladle
B	62609	15,10	7x9	31,0	1	<b>Cacillo salsa</b> · Louche sauce · Gravy ladle
C	62607	12,90	7x10	32,0	6	<b>Cuchara</b> · Cuillère · Ladle
D	62608	12,10	7x10	32,0	1	<b>Cuchara perforada</b> · Cuillère perforee · Perforated ladle
E	62604	17,30	Ø11	36,5	6	<b>Espumadera</b> · Ecumoire · Skimmer
F	62606	12,60	8x9	33,5	6	<b>Espátula</b> · Spatule · Spatula
G	62605	11,00	3x8	33,5	1	<b>Tenedor</b> · Fourchette · Fork
H	62811	14,40	Ø7,5	31,0	6	<b>Servidor espaguetis</b> · Cuillère à spaguetis · Spaguetti server
I	62601	92,60	-	-	1	<b>Juego 5 piezas</b> · 5 utensiles de cuisine · 5 pds. kichen tools
J	62630	24,60	40	-	1	<b>Soporte juego</b> · Soutien · Hanging rack



Cacillo (62603)  
Espumadera (62604)  
Tenedor (62605)  
Espátula (62606)  
Cuchara lisa (62607)

# Monoblock Collection

INOX 18/10  
Dishwasher



	Ref	€	cm	Largo (cm)	U.Venta	
A	62503	8,40	Ø9	31,5	1	<b>Cacillo</b> · Louche · Ladle
B	62507	6,80	6,5x10	34,5	1	<b>Cuchara</b> · Cuillère · Ladle
C	62504	8,50	Ø11,5	35,0	1	<b>Espumadera</b> · Ecumoire · Skimmer
D	62506	6,60	8x10	35,5	1	<b>Espátula</b> · Spatule · Spatula
E	62505	5,70	2,5x10	33,5	1	<b>Tenedor</b> · Fourchette · Fork



# DUE Collection

PA INOX SI  
Nylon 18/10 Silicone Dishwasher BPA free

- **Colección de utensilios de nylon, ofrece un diseño versátil y cómodo.**
  - **Mangos fabricados en acero inoxidable 18/10 de gran calidad y resistencia.**
  - **Utensilios antiadherentes y flexibles.**
  - **Soporta fuertes cambios de temperatura.**
  - **Libres de BPA.**
- Collection d'ustensiles en nylon, offrant un design polyvalent et confortable.
  - Poignées en acier inoxydable 18/10 de haute qualité et résistant.
  - Ustensiles antiadhésifs et flexibles.
  - Résiste aux fortes variations de température.
  - Sans BPA.
- Nylon utensils collection, offering a versatile and comfortable versatile and comfortable design.
  - Handles made of high quality and resistant 18/10 stainless steel.
  - Non-stick and flexible utensils.
  - Withstands strong temperature changes.
  - BPA free



	Ref	€	cm	Largo (cm)	U.Venta	
A	68270	8,60	7x10,5	36,5	6	<b>Cuchara</b> · Cuillère · Ladle
B	68271	8,80	10,5x9,5	33,5	6	<b>Cacillo</b> · Louche · Ladle
C	68272	8,60	10,5x10,5	36,5	6	<b>Espumadera</b> · Ecumoire · Skimmer
D	68274	8,80	8,5x10,5	37,5	6	<b>Espátula</b> · Spatule · Spatula
E	68275	8,70	8,5x10,5	37,5	6	<b>Espátula perforada</b> · Spatule perforee · Perforated spatule
F	68273	8,30	6,5x9,5	36,5	6	<b>Servidor espaguetis</b> · Cuillère à spaguetis · Spaguetti server
G	68276	8,80	8x14,5	36,5	6	<b>Paleta de pescado</b> · Pelle à poisson · Fish turner

# Black Collection

PA Nylon Dishwasher BPA free



	Ref	€	cm	Largo (cm)	U.Venta
A	98903	3,90	8x9,5	31,0	12
B	98907	3,90	6,5x10	30,0	12
C	98908	3,90	6,5x9	30,0	12
D	98905	3,90	7,5x9	25,0	12
E	98906	3,90	9x10	31,0	12
F	98912	3,90	8x12	28,0	12
G	98913	3,90	4x7	31,0	12
H	98904	3,90	Ø11	33,0	12
I	98910	3,90	6x8,5	27,0	12
J	98911	3,90	6x8	30,0	12
K	98909	3,90	8x16	32,0	12
L	98914	3,90	7x7	30,0	12

**Cacillo** · Louche · Ladle  
**Cuchara** · Cuillère · Ladle  
**Cuchara perforada** · Cuillère perforee · Perforated ladle  
**Cuchara salsa** · Cuillère sauce · Gravy spoon  
**Espátula perforada** · Spatule perforee · Perforated spatule  
**Espátula corta** · Spatule court · Short spatule  
**Espátula larga** · Spatule longue · Long spatule  
**Espumadera** · Ecumoire · Skimmer  
**Cacillo salsa** · Louche sauce · Gravy ladle  
**Servidor espaguetis** · Cuillère à spaguetis · Spaguetti server  
**Paleta de pescado** · Pelle à poisson · Fish turner  
**Batidor** · Fouet · Whisk

# ECO Collection

PA Nylon Dishwasher BPA free



	Ref	€	cm	Largo (cm)	U.Venta
A	98803	5,20	Ø9,5	29,0	12
B	98807	4,40	7,5x10	30,5	12
C	98808	4,10	7,5x10	30,5	12
D	98804	4,90	Ø11	31,5	12
E	98806	4,50	8x10	33,0	12
F	98810	3,90	8x6,5	27,0	12
G	98811	4,00	Ø7,5	29,0	12

**Cacillo** · Louche · Ladle  
**Cuchara** · Cuillère · Ladle  
**Cuchara perforada** · Cuillère perforee · Perforated ladle  
**Espumadera** · Ecumoire · Skimmer  
**Espátula perforada** · Spatule perforee · Perforated spatule  
**Cacillo salsa** · Louche sauce · Gravy ladle  
**Servidor espaguetis** · Cuillère à spaguetis · Spaguetti server

# Aqua Garinox Collection

PP Polypropylene Dishwasher BPA free



**garinox**®

	Ref	€	cm	U.Venta
A	64480	2,30	32,5	1
B	64481	2,30	33,5	1
C	64482	2,30	32,5	1
D	64483	2,30	32,5	1
E	64484	2,30	29,5	1

**Cacillo** · Louche · Ladle  
**Espumadera** · Ecumoire · Skimmer  
**Espátula perforada** · Spatule perforee · Perforated spatule  
**Cuchara** · Cuillère · Ladle  
**Servidor espaguetis** · Cuillère à spaguetis · Spaguetti server

new

# Grey Collection



**Núcleo reforzado para una mayor resistencia sin perder flexibilidad en los bordes.**  
**Diseñados en una sola pieza, sin costuras ni grietas**  
 Reinforced core improves strength without losing flexibility around the edges.  
 Designed in a single piece without seams or cracks



	Ref	€	cm	Largo (cm)	U.Venta	
A	64466	7,90	Ø9,5	29,0	1	<b>Cacillo</b> · Louche · Ladle
B	64469	7,00	5,6x9,5	29,0	1	<b>Cuchara</b> · Cuillère · Ladle
C	64467	7,90	Ø9	29,0	1	<b>Espumadera</b> · Ecumoire · Skimmer
D	64468	7,00	7,5x9,5	29,0	1	<b>Espátula perforada</b> · Spatule perforée · Perforated spatule
E	64470	7,70	5,5x9,5	27,0	1	<b>Servidor espaguetis</b> · Cuillère à spaguëtis · Spaguëtti server
F	64471	7,00	4x12,5	27,0	1	<b>Espátula estrecha</b> · Spatule étroite · Narrow spatule
G	64462	7,90	-	29,0	1	<b>Pinza larga</b> · Pince longue · Long tong
H	64463	5,60	-	27,5	1	<b>Cuchara</b> · Cuillère · Ladle
I	64464	5,60	5,5x8	27,5	1	<b>Espátula</b> · Spatule · Spatula
J	64465	5,70	-	27,5	1	<b>Pincel</b> · Pinceau · Brush

# Brun Collection



**Fabricadas en madera de haya natural de alta calidad, acabadas con aceites naturales**  
 Made from natural beech wood of high quality and finished with natural oils



	Ref	€	cm	Largo (cm)	U.Venta	
A	68175	6,20	6x10	30,0	6	<b>Cuchara</b> · Cuillère · Ladle
B	68176	6,50	7x10	30,0	6	<b>Cuchara perforada</b> · Cuillère perforée · Perforated ladle
C	68177	6,20	6,5x10	30,0	6	<b>Espátula</b> · Spatule · Spatula
D	68178	6,40	7,5x12	30,0	6	<b>Espátula perforada</b> · Spatule perforée · Perforated spatule
E	68179	6,70	6,5x10	30,0	6	<b>Cuchara especial</b> · Cuillère spéciale · Special spoon
F	68173	7,20	8x7	30,0	6	<b>Cuchara ensalada</b> · Cuillère à salade · Salad spoon
G	68174	7,20	8x7	30,0	6	<b>Tenedor ensalada</b> · Fourchette à salade · Salad fork

# Nordic Collection



**Cabezal fabricado en nylon, resistente y duradero, libre de BPA. Mango ergonómico de madera de haya 100% natural**  
 Head made of nylon. Strong and long lasting. BPA free. Ergonomic natural beech wood handle.



	Ref	€	cm	Largo (cm)	U.Venta	
A	68280	4,90	Ø9	32,0	1	<b>Cacillo</b> · Louche · Ladle
B	68281	4,90	6,2	34,0	1	<b>Cuchara</b> · Cuillère · Ladle
C	68282	4,90	8,4	35,3	1	<b>Espátula perforada</b> · Spatule perforée · Perforated spatule
D	68283	4,90	11,2	34,3	1	<b>Espumadera</b> · Ecumoire · Skimmer
E	68284	4,90	6,5	34,0	1	<b>Servidor espaguetis</b> · Cuillère à spaguëtis · Spaguëtti server

# Unite Collection



	Ref	€	cm	Largo (cm)	U.Venta	
A	68187	6,90	Ø8	31,5	1	<b>Cacillo</b> · Louche · Ladle
B	68185	6,00	6,7x10,5	32	1	<b>Cuchara</b> · Cuillère · Ladle
C	68195	4,40	5,6x8,5	26,5	1	<b>Espátula</b> · Spatule · Spatula
D	68186	6,10	7,5x10,5	33,5	1	<b>Espátula perforada</b> · Spatule perforée · Perforated spatule
E	68188	7,00	Ø11,5	33,5	1	<b>Espumadera</b> · Ecumoire · Skimmer
F	68189	6,10	5,5x9,5	32,5	1	<b>Servidor espaguetis</b> · Cuillère à spaguëtis · Spaguëtti server
G	68196	4,20	5,5x0,5	24,5	1	<b>Pincel</b> · Pinceau · Brush
H	68197	4,30	-	14,5	1	<b>Pelador liso</b> · Éplucheuse plate · Peeler plain blade
I	68198	4,30	-	14,5	1	<b>Pelador dentado</b> · Éplucheuse dentelé · Serrated peeler
J	68199	6,10	-	27,0	1	<b>Batidor</b> · Fouet · Whisk

# BBQ Collection

INOX   
Dishwasher

- **Práctico maletín de aluminio compuesto por 5 utensilios para barbacoa: espátula, tenedor, cuchillo, pinza dentada y brocha.**
- **Todas las piezas fabricadas en acero inoxidable de máxima calidad.**
- **Mango ergonómico, resistente al calor.**
- **Completa el set con los accesorios adicionales: espátula acodada y cepillo de limpieza.**

- Malette pratique en aluminium composée de 5 ustensiles pour barbecue : spatule, fourchette, couteau, pince dentée et broche.
- Toutes les pièces sont fabriquées en acier inoxydable de la plus grande qualité.
- Manche ergonomique, résistant à la chaleur.
- Complétez l'ensemble avec les accessoires supplémentaires : spatule coudée et brosse de nettoyage.

- Practical aluminium case with 5 barbecue utensils: spatula, fork, knife, serrated tongs and brush.
- All parts made of top-quality stainless steel.
- Ergonomic, heat-resistant handle.
- Complete the set with these additional accessories: angled spatula and cleaning brush.



**Maletín**  
Malette · Koffer  
Briefcase · Maleta

Ref	€	cm	U.Venta
60260	48,00	47x16,6x8	1

**Tenedor**  
Fourchette · Tranchiergabel  
Fork · Garfo

Ref	€	Largo (cm)	U.Venta
60261	5,20	43,5	1

**Cuchillo**  
Couteau · Messer  
Knife · Faca

Ref	€	Largo (cm)	U.Venta
60262	5,00	41,5	1



**Espátula**  
Spatule · Schaufel  
Spatule · Espátula

Ref	€	Largo (cm)	U.Venta
60263	8,30	45,5	1

**Brocha**  
Broche · Bürstes  
Brush · Escova

Ref	€	Largo (cm)	U.Venta
60264	6,30	44,0	1



**Pinza**  
Pincs · Zange  
Tong · Pinça

Ref	€	Largo (cm)	U.Venta
60265	10,20	43,5	1



## Accesorios · Accessoires · Accessories

**Espátula acodada**  
Spatule coudées · Winkelpalette  
Bent spatule · Espátula comprida

Ref	€	Largo (cm)	U.Venta
60266	6,00	28,0	1



**Cepillo de limpieza**  
Brosse de nettoyage · Reinigungsbürste  
Cleaning brush · Escova de limpeza

Ref	€	Largo (cm)	U.Venta
60267	7,00	45,0	1



# BBQ Nordic Collection

INOX 

- **Fabricadas en acero inoxidable de gran calidad.**
- **Mango de madera de caucho con un acabado barnizado.**
- **Agarre cómodo y firme.**
- **Práctica cuerda de cuero para colgar.**

- Fabriquées en acier inoxydable de haute qualité.
- Manche en bois de caoutchouc verni.
- Préhension confortable et ferme.
- Elle dispose d'un cordon en cuir pour la suspendre.

- Made of high quality stainless steel.
- Rubberwood handle with a varnished finish.
- Easy and firm grip.
- It has a leather cord for hanging.

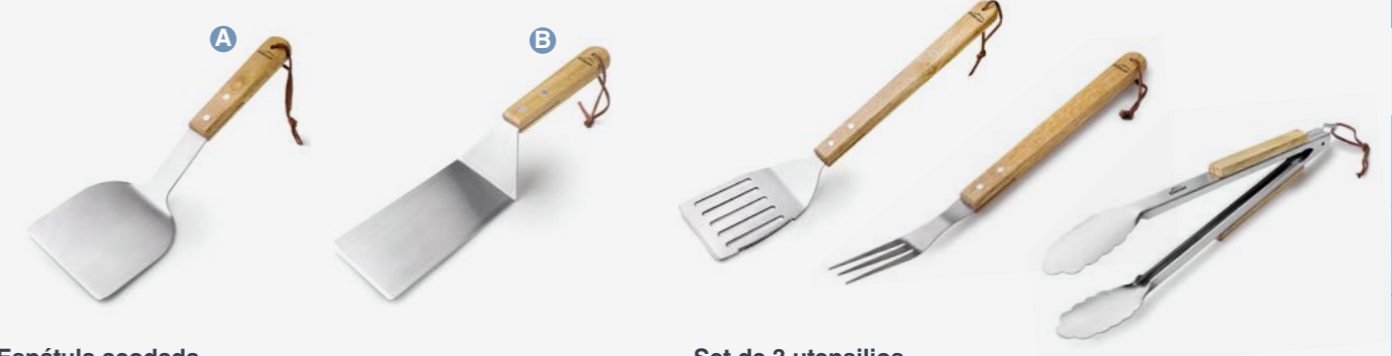

**Espátula acodada**  
Spatule coudée · Gewinkelter Spachtel  
Angled spatula · Espátula angular

	Ref	€	Largo (cm)	U.Venta
A	60268	4,80	30,5	1
B	60269	5,20	34,0	1

**Set de 3 utensilios**  
Set de 3 ustensiles · Satz mit 3 Utensilien  
Set of 3 utensils · Conjunto de 3 utensílios

	Ref	€	Largo (cm)	U.Venta
	60270	14,70	47,6	1
			47,0	
			40,0	

# Cacillo Select

INOX 

- **Fabricados en acero inoxidable de gran calidad.**
- **Gran resistencia y durabilidad, diseñados para un uso intensivo.**
- **Mango revestido de PVC aislante que permite un agarre cómodo y antideslizante.**
- **Disponibles en distintos colores.**

- Fabriqué en acier inoxydable de haute qualité.
- Très résistant et durable, conçu pour un usage intensif.
- Poignée recouverte de PVC isolant pour une prise en main confortable et antidérapante.
- Disponible en différentes couleurs.

- Made of high quality stainless steel.
- Highly resistant and durable, designed for intensive use.
- Handle coated with insulating PVC for a comfortable non-slip grip.
- Available in different colours.

**Cacillo Select**  
Louche · Schöpfkelle  
Ladle · Colher

Ref	€	Ø (cm)	h(cm)	ml	U.Venta
60655	4,10	5,00	25,50	29,50	1
60656	4,20	6,00	26,00	60,00	1
60657	4,40	7,00	27,00	89,00	1
60658	4,70	8,00	34,50	118,00	1
60659	5,40	8,50	34,50	148,00	1



# Utensilios Varios

INOX  
18/10  
Dishwasher

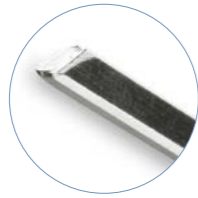

Sección cuadrada  
(2,5x2,5 mm)  
Square section



## Pincho moruno 6u

Brochette carre en inox. (6) · Fleischspiesse (6), Rostfrei  
St. steel skewersquare wire (6) · Espeto moruno Inóx (6)

Ref	€	Largo (cm)	U.Venta
* 62446	5,00	20,0	12
62435	5,70	30,5	12
62445	6,80	40,5	12

\* Apto para las freidoras de aire · Suitable for air fryers



## Cuchara apoya utensilios

Cuillère ramasse ustensiles · Vorlegelöffel  
Spoon holder utensils · Colher recolhe utensilios

Ref	€	cm	Largo (cm)	U.Venta
62972	11,80	25x12	25	1



AL  
Aluminium

## Barra sujeción notas

Barre à notes · Zettelhalter  
Order rall · Barra fixação notas

Ref	€	Largo (cm)	U.Venta
60731	12,00	30,50	1
60746	15,60	46,00	1
60761	18,70	61,00	1
60776	21,60	76,00	1
60791	26,80	91,50	1



## 6 ganchos carnicero

6 crochets de boucher · 6-Tlg Metzgerhaken  
6 butchers hook · 6 ganchos de carnicero

Ref	€	Puntas	Ø (mm)	Largo (cm)	U.Venta
A 39043	12,00	1	5	12,5	4
39044	18,60	1	5	18,5	1
B 39047	12,10	2	5	12,5	4
39048	18,80	2	5	18,5	1



INOX

## Contenedor cubiertos

Panier à couverts · Besteckköcher  
Cutlery holder · Copos para talheres

Ref	€	Ø (cm)	h(cm)	L	U.Venta
62962	21,60	12	13,6	1,40	1
62963	25,10	12	18,7	2,00	1



## Colgador de barra

Penderie murale · Hängeleiste  
Wall hanger · Suporte de barra

Ref	€	Unidades	Largo (cm)	U.Venta
60740	23,10	6	40	1
60760	31,90	8	60	1
60710	44,10	12	100	1
A 60700	6,90	6	-	12

Juego 6 ganchos  
Ensemble 6 crochets  
6 hook set

Preparación  
Food processing

# Espátulas

INOX  
Dishwasher



**Espátula de pescado Flex**  
Spatule flexible à poisson · Fisch Schaufel, flexible  
Flexible spatula to fish · Espátula flexível para peixe

Ref	€	Largo (cm)	U.Venta
60426	4,50	30	6



INOX 18/10  
Silicone  
BPA free

**Espátula de pescado Pro**  
Spatule à poisson · Fischheber  
Fish spatula · Espátula de peixe

Ref	€	Largo (cm)	U.Venta
60726	14,00	30	1



**Espátula serrada**  
Spatule à gâteau · Backschaufel  
Serrated spatula · Espátula com serrilha

Ref	€	cm	U.Venta
62677	9,00	30x5,5	6



**Espátula grill**  
Spatule coudée our grill · Winkelpalette  
Bent grillspatula · Espátula comprida grelha

Ref	€	cm	U.Venta
60434	6,10	12x27	6



**Paleta triangular**  
Grattoir manche noir m/solide · Bratenspachtel, Stiel  
Straight Scraper/turner · Espátula triangular cabo sólido

Ref	€	cm	U.Venta
60430	7,00	10x11,5	12



**Espátula lisa Bent**  
Spatule lisse m/solide · Backschaufel, f. Feststoffe  
Straight spatula · Espátula lisa cabo sólido

Ref	€	cm	U.Venta
60425	4,90	7x13,5	12

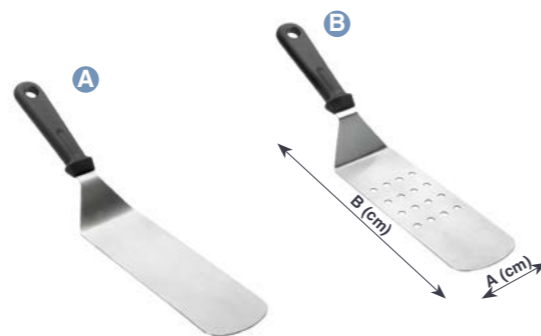

**Espátula repostería**  
Pâtisserie spatule · Gebackpalette  
Pastry spatula · Espátula pastelaria

Ref	€	cm	U.Venta
60443	4,10	6,5x14,5	12

**Espátula para emplatar**  
Mini spatule coudée · Winkelpalette Mini  
Mini bent spatula · Espátula mini comprida

Ref	€	cm	U.Venta
60442	3,80	2x9	12

**Espátula lisa Black**  
Spatule lisse m/solide · Spachtel, mit solidem Stiel  
Straight spatula · Espátula lisa cabo sólido

Ref	€	AxB (cm)	U.Venta
A 60420	5,40	7,5x21,5	12
B 60421	5,30	7,5x21,5	12



2 in 1  
Cortar · Cut  
Servir · Serve up

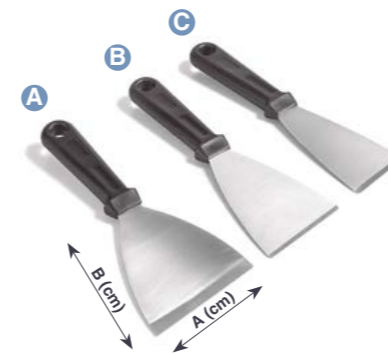

**Espátula para plancha**  
Spatule m/solide · Grillspachtel, mit solidem Stiel  
Straight spatula · Espátula grelha cabo sólido

Ref	€	A (cm)	B (cm)	U.Venta
A 60422	4,70	10	11,5	12
B 60445	4,00	8	11,5	12
C 60446	3,90	6	11,5	12



**Espátula lisa Ring**  
Spatule manche noir · Schaufel mit schwarzem Stiel  
Solid turner w/black H. · Espátula cabo negro

Ref	€	AxB (cm)	Largo (cm)	U.Venta
A 60435	7,80	7,5x17	35	6
B 60438	7,90	7,5x17	35	6



**Espátula acodada**  
Spatule coudée · Winkelpalette  
Bent spatula · Espátula comprida

Ref	€	cm	U.Venta
60482	4,00	4x15	12
60483	4,30	4x19	12
60484	4,60	4x24	12



**Espátula larga acodada**  
Spatule longue coudée m/solide · Winkelpalette, lang  
Long bent spatula · Espátula comprida c/cabo sólido

Ref	€	Largo (cm)	U.Venta
60467	4,00	20	12
60468	4,10	25	12
60469	4,20	30	12



**Espátula larga recta**  
Spatule longue droite m/solide · Palette, lang, gerade  
Long straight spatula · Espátula comprida c/cabo sólido

Ref	€	Largo (cm)	U.Venta
60461	3,80	15	12
60462	3,90	20	12
60463	4,00	25	12
60464	4,10	30	12
60465	4,20	35	12



INOX 18/10  
**Espátula gigante Inox**  
Spatule geante en Inox · Rührspatel, Edelstahl  
St steel long handle Turner · Espátula gigante Inóx

Ref	€	Largo (cm)	U.Venta
61481	68,40	80	1
61421	74,80	120	1

PE  
Polyethilene  
**Pala profesional**  
Pelle professionnelle · Professionelle Ruhrspatel  
Professional shovel · Pá professional

Ref	€	Largo (cm)	U.Venta
60404	79,30	81,5	1

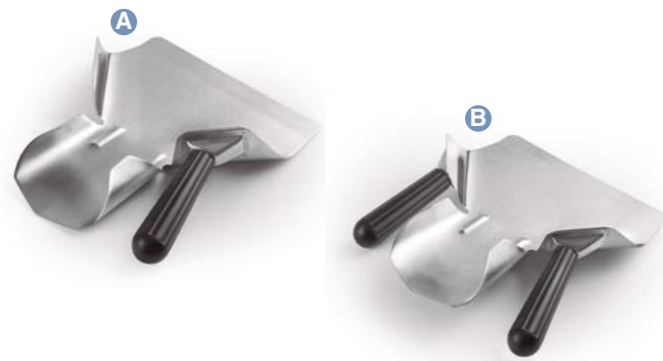

- Pala profesional fabricada en acero inoxidable de gran calidad.
- Diseño trapezoidal para recoger y embolsar patatas fritas en fracciones individuales de forma rápida.
- Multifuncional: también se puede usar para servir palomitas de maíz, nueces, hielo o dulces.
- 1 o 2 mangos ergonómicos y antideslizantes para usuarios zurdos y diestros.
- Fácil de limpiar. Apta para el lavavajillas.

- Pelle professionnelle en acier inoxydable de haute qualité.
- Conception trapézoïdale pour collecter et embolier rapidement les pommes de terre frites dans des fractions individuelles.
- Multifonctionnel: il peut également être utilisé pour servir le maïs, les noix, la glace ou les bonbons.
- 1 ou 2 manguos ergonomiques et non glissantes pour les utilisateurs de gauche et de droite.
- Facile à nettoyer. Convient au lave-vaisselle.

### Pala para patatas

Pelle à pommes de terre · Kartoffelschaufel  
Potato shovel · Pá de batatas

	Ref	€	cm	Nº Asas	U.Venta
A	62678	12,90	20x22	1	1
B	62679	15,20	20x22	2	1

## Espátulas de silicona



FE  
Iron

### Utensilios Grey

Ustensiles en silicone · Silikonutensilien  
Silicone utensils · Utensilios de silicone

	Ref	€	Largo (cm)	U.Venta
A	64463	5,60	27,5	1
B	64464	5,60	27,5	1
C	64465	5,70	27,5	1



FE  
Iron

### Utensilios Ocean

Ustensiles en silicone · Silikonutensilien  
Silicone utensils · Utensilios de silicone

	Ref	€	Largo (cm)	U.Venta
Set	64452	17,20	27,5	1
A	64453	6,00	27,5	1
B	64454	6,00	27,5	1
C	64455	6,00	27,5	1



Mango ABS · ABS handle

### Espátula Comfort

Spatule en silicone · Teigschaber  
Silicone spatula · Espátula de silicone

	Ref	€	Largo (cm)	U.Venta
A	64444	6,10	28	1
B	64445	6,80	30	1
C	64446	6,90	31	1



### Espátula White

Spatule en silicone · Teigschaber  
Silicone spatula · Espátula de silicone

	Ref	€	Largo (cm)	U.Venta
	67421	4,70	20	1
	67427	7,00	26	1
	67433	15,30	32	1



### Espátula Grey

Spatule en silicone · Teigschaber  
Silicone spatula · Espátula de silicone

	Ref	€	Largo (cm)	U.Venta
	67434	4,80	30	12
	67435	5,60	29	12



### Espátula Unite

Spatule · Backschauffel  
Spatule · Espátula

	Ref	€	cm	Largo (cm)	U.Venta
	68195	4,40	5,6x8,5	26,5	1



### Espátula silicona

Spatule en silicone · Teigschaber  
Silicone spatula · Espátula de silicone

	Ref	€	Largo (cm)	U.Venta
A	64450	5,70	25	6
	64451	9,10	35	6
	64460	6,00	25	6
B	64461	10,00	35	6

### Espátula para tarros

Spatule pour pots · Spatel für Einmachgläser  
Jar spatula · Espátula para frascos

	Ref	€	cm	Largo (cm)	U.Venta
	64490	2,50	3,8x8,4	25	1
	64491	4,10	4,8x10,8	35	1

### Espátula profesional ExtraPlana

Spatula professionnelle · Profi-Spachtel  
Professional spatula · Espátula profesional

	Ref	€	Largo (cm)	U.Venta
	61373	5,60	30	1
	61375	6,20	35	1
	61374	7,50	40	1

### Set repostería- 20 pcs.

Exposant pâtisserie · Aufsteller Pastry  
Pastry display · Expositor pastelería

	Ref	€	Largo (cm)	Piezas	U.Venta
	64424	80,40	-	Caja (20 pcs.) · Set (20 pcs.)	1
A	64426	4,10	23,0	Pincel · Brush	12
B	64427	4,10	23,0	Espátula · Spatula	12
C	64428	4,10	23,0	Lengua gato · Spatula	12
D	64429	4,10	23,0	Batidor · Whisk	12



## Rasquetas



### Rasqueta

Coupe pate · Schaber  
Scraper · Raspador

	Ref	€	cm	U.Venta
	67041	25,80	13,8x13	1

Diseño apilable  
Stackable design



### Rasqueta Flex

Coupe pate · Schaber  
Scraper · Raspador

	Ref	€	cm	U.Venta
	67414	9,10	9x15	1

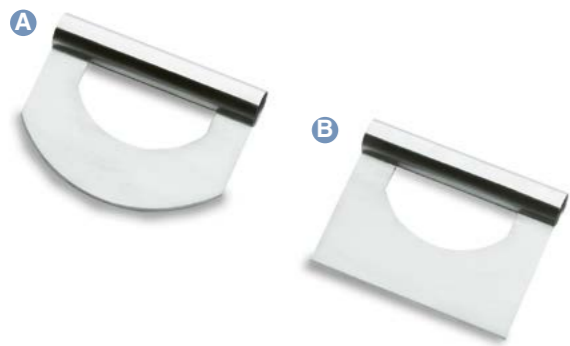

**Rasqueta Inox**  
Coupe pate · Schaber  
Scraper · Raspador

	Ref	€	cm	U.Venta
A	67005	13,20	15x9	6
B	67006	12,70	15x9	6



**INOX**  
18/10

**Rasqueta Inox Black**  
Coupe pate · Schaber  
Scraper · Raspador

	Ref	€	cm	U.Venta
	67029	9,70	16,5x10,5	6

## Pizza Collection

**INOX**  
Oven



**Cacillo salsa**  
Louche sauce · Saucengliesslöffel  
Gravy ladle · Concha para molho

	Ref	€	Ø (cm)	Largo (cm)	Capacidad	U.Venta
	60562	5,70	7	27,0	80 g	1



**Soporte para hornear pizzas**  
Support avec plaques à pizzas · Pizza Backblech  
Pizza baking rack · Suporte para cozer pizzas no forno

	Ref	€	Bandejas	Ø (cm)	h(cm)	U.Venta
	61462	24,90	4	29,5	21	1



**INOX**  
18/10

**Espátula pizza**  
Spatule pizza · Pizzaspatel  
Pizza spatula · Espátula pizza

	Ref	€	cm	U.Venta
	60424	14,20	16,5x17,5x5	1



**INOX**  
18/10

**Pala Pizza**  
Pelle pizza · Pizzaschaufel, flach  
Pizza flat scoop · Espátula pizza

	Ref	€	cm	U.Venta
	61461	14,40	25x36	1



**Pala pizza Lungo**  
Pelle pizza · Pizzaofen-Schaufel  
Pizza oven scoop · Pá de pizza

	Ref	€	Largo (cm)	U.Venta
	61460	105,70	160	1

**Mango es desmontable**  
handle is removable



**Pala pizza Wood**  
Pelle pizza · Pizzaofen-Schaufel  
Pizza oven scoop · Pá de pizza

	Ref	€	cm	Largo (cm)	U.Venta
	61463	23,20	30,5x35,5	88	1

**Fabricada en aluminio**  
Made of aluminum

**Cortapizza PRO**  
Roulette pizza · Pizzaschneider  
Pizza cutter · Corta-Pizza

	Ref	€	Largo (cm)	U.Venta
	61465	7,70	35	1



**Cortapizza Basic**  
Roulette pizza · Pizzaschneider  
Pizza cutter · Corta-Pizza

	Ref	€	Ø (cm)	U.Venta
	60429	5,10	10	12



**Cortapizza Luxe**  
Roulette pizza · Pizzaschneider  
Pizza cutter · Corta-Pizza

	Ref	€	Ø (cm)	U.Venta
	67004	18,00	10	1



**Cortapizza Plus**  
Roulette pizza · Pizzaschneider  
Pizza cutter · Corta-Pizza

	Ref	€	Ø (cm)	U.Venta
	67028	12,40	10	1



**INOX**  
18/10

**Cortapizza Ergonomic**  
Roulette pizza · Pizzaschneider  
Pizza cutter · Corta-Pizza

	Ref	€	Ø (cm)	U.Venta
	67027	6,00	8	6







# Batidores

INOX 18/10  
Dishwasher

INOX

## Batidor mini

Mini fouet Inox · Mini-Schneebeesen  
Mini whisk · Mini batedor Inóx

Ref	€	Largo (cm)	U.Venta
61615	5,60	15	12
61620	6,20	20	12



SI 250°C  
Silicone Max BPA free

## Batidor varilla silicona

Fouet en silicone · Ruhrbesen auf Silikon  
Silicone wire whisk · Batedor vareta silicone

Ref	€	Largo (cm)	U.Venta
61621	8,20	20	12
61622	9,10	25	6
61623	10,20	30	12

## Batidor Extra 8

Fouet inox extra 8 · Schneebeesen, Extra 8  
Extra 8 whisk · Batedor Extra 8

Ref	€	Largo (cm)	U.Venta
61625	8,70	25	6
61630	8,90	30	6
61635	9,30	35	6
61640	10,30	40	6
61645	11,10	45	6
61650	12,40	50	6
61655	13,20	55	6
61660	14,20	60	6

## Batidor gigante

Fouet à purée · Kesselbesen  
Big whisk · Batedor gigante

Ref	€	cm	Diámetro varilla (mm)	U.Venta
60610	64,10	100	3	12
60612	82,20	129	3	12

## Batidor Super 12

Fouet inox super 12 · Schneebeesen, super 12  
Super 12 whisk · Batedor Super 12

Ref	€	Largo (cm)	U.Venta
61626	8,00	25	6
61631	8,60	30	6
61636	9,30	35	6
61641	9,90	40	6
61646	10,20	45	6
61651	11,10	50	6



INOX 18/10 SI Silicone HAYA Wood LFGB Food Grade Silicone Dishwasher BPA free

## Batidor varilla con espátula

Fouet avec grattoir · Schneebeesen mit Schaber  
Whisk with spatula · Batedeira de varas com espátula

Ref	€	Largo (cm)	U.Venta
A 68199	6,10	27,0	1
B 61627	6,40	32,0	12



Especial para preparar comidas que no contengan alérgenos.  
Specially for preparing meals that do not contain allergens.

SI 250°C  
Silicone Max BPA free

## Batidor Fibreglass

Fouet · Schneebeesen  
Whisk · Batedores

Ref	€	Largo (cm)	U.Venta
61624	12,10	25	6
61629	14,00	30	6
61634	15,80	35	6
61639	17,50	40	6
61644	21,00	45	6
61649	22,00	50	6

INOX

## Batidor Manivela

Batteur-mélangeur à manivelle · Schneequirl  
Egg beater · Batedor de manivela

Ref	€	U.Venta
62901	19,60	6



- Batidor de varilla con práctico raspador de silicona incorporado.
- 2 en 1: bate y recoge toda la mezcla del bol de forma fácil y rápida.
- Varillas fabricadas en acero inoxidable.
- Espátula de silicona inyectada en una de las varillas (certificado LFGB y libre de BPA).

- Mixeur en bâton avec raclette en silicone intégrée très pratique.
- 2 en 1: fouette et recueille tous les mélanges dans le bol rapidement et facilement.
- Lames en acier inoxydable.
- Spatule en silicone injectée dans l'une des lames (certifiée LFGB et sans BPA).

- Blade mixer with practical built-in silicone scraper.
- 2 in 1: Beat and scrape out the entire mixture from the bowl quickly and easily.
- Rods made of stainless steel.
- Silicone spatula injected into one of the blades (LFGB certified and BPA free).



Ref	€	Largo (cm)	U.Venta
61590	11,10	25	6
61591	12,00	30	6
61592	14,00	35	6

## Batidor silicona Fibreglass

Fouet en silicone · Schneebeesen, Silikon  
Silicone whisk · Batedores silicone

Ref	€	Largo (cm)	U.Venta
61524	11,10	25	6
61529	12,00	30	6
61534	14,00	35	6

## Batidor Capuccino

Batteur pour cappuccino · Capuccino-Mixer  
Capuccino mixer · Batedor capuccino

Ref	€	W	U.Venta
69041	27,40	2,7	1





# Coladores

INOX 18/10 Dishwasher

Possibilidad de completar colador en 4 sectores solicitando 4 unidades  
Possibility of completing strainer in 4 sectors requesting 4 units



**Colador 4 sectores**  
Passoire · Teigwaren-Einsatz  
Colander · Coador

Ref	€	Ø (cm)	h(cm)	U.Venta
50334	71,40	36	23,0	1
50338	86,50	40	26,0	1

**Colador tipo cazo**  
Passoire à queue · Seihner mit Stiel  
Strainer · Coador

Ref	€	Ø (cm)	h(cm)	L	U.Venta
50320	57,20	20	12	3,5	1
50324	65,20	24	14	6,5	1
50328	76,40	28	15	9,3	1



**Colador chino**  
Passoire "Chinois" · Spitzsieb mit Flachstiel  
"Chinese" strainer · Passador chinês

Ref	€	Ø (cm)	U.Venta
60311	17,80	10	1
60313	18,30	12	1
60315	19,20	14	1
60317	21,00	16	1
60318	22,20	18	1
60320	24,00	20	1
60322	26,10	22	1
60324	27,40	24	1
60326	29,40	26	1

**Colador chino con pestaña**  
Passoire "Chinois" manche fil · Spitzsieb mit Rundstiel  
Wire handle "Chinese" strainer · Passador chinês c/flange

Ref	€	Ø (cm)	U.Venta
60316P	17,60	16	1
60318P	18,80	18	1
60320P	20,20	20	1
60322P	22,90	22	1
60324P	24,40	24	1

**Colador chino sin pestaña**  
Passoire "Chinois" manche fil · Spitzsieb mit Rundstiel  
Wire handle "Chinese" strainer · Passador chinês s/flange

Ref	€	Ø (cm)	U.Venta
60316V	18,30	16	1
60319V	20,70	20	1



**Colador chino de malla**  
Passoire "Chinois" toile-metallique · Gazespitzsieb  
Meshed "Chinese" strainer · Coador chinês de rede

Ref	€	Ø (cm)	U.Venta
60319	28,60	18	1
60321	35,40	20	1
60323	35,80	22	1
60325	39,30	24	1

**Colador malla c/refuerzo**  
Chinois toile-metallique a croissillon · Gewebedurchschlang, konisch, verstärkt  
Conical mesh strainer w/protection · Coador de rede c/reforço

Ref	€	Ø (cm)	U.Venta
62621	54,20	20x22	1



**Colador 1/2 esfera**  
Passe-bouillon · Passiersieb  
Sieve · Coador 1/2

Ref	€	Ø (cm)	U.Venta
62680	5,30	8	1
62610	8,90	10	1
62612	11,50	12	1
62614	13,20	14	1
62616	15,60	16	1
62618	18,30	18	1
62620	23,70	20	1
62623	28,50	23	1

**Colador Cónico**  
Passoire conique · Passiersieb, konisch  
Conical sieve · Coador cónico

Ref	€	Ø (cm)	U.Venta
62690	7,20	8	1
62611	9,60	10	1
62613	12,30	12	1
62615	15,40	14	1
62617	18,20	16	1
62619	21,10	18	1

**Nidos de alambre**  
Panier à nid · Nestbacklöffel  
Bird's nest mould · Ninhos de arame

Ref	€	cm	Largo (cm)	U.Venta
62957	23,20	7-9	35	1
62959	27,10	9-11	37	1



INOX PP Polypropylene BPA free

**Colador Drain**  
Passe-bouillon · Passiersieb  
Sieve · Coador

Ref	€	Ø (cm)	U.Venta
62697	5,30	7,5	6
62691	8,00	12,0	6
62698	12,70	18,0	6
62692	14,60	22,0	1

Mango de madera  
Wooden handle



INOX

**Colador doble malla**  
Passoir maillee · Passiersieb, stark  
Mesh strainer · Coador rede dupla

Ref	€	Ø (cm)	Largo (cm)	U.Venta
61316	8,30	16	32,0	1
61318	9,70	18	34,0	1
61320	11,30	20	37,0	1
61323	28,80	23	56,0	1
61326	31,30	26	58,0	1
61330	55,80	30	78,5	1
61335	67,30	35	84,0	1

2 Ganchos  
2 Hooks

1 Gancho  
1 Hook

Alambre estañado · Fil étamé · Tinned wire

HAYA Wood Dishwasher

**Mano chino**  
Poussoir à chinois · Holz-Stößel  
Chinesse strainer pusher · Pilão p/passador chinês

Ref	€	Largo (cm)	U.Venta
60300	6,30	25	1

PE Polyethylene BPA free

**Triángulo**  
Triangle · Dreieck  
Triangle · Triângulo

Ref	€	U.Venta
60402	56,80	1

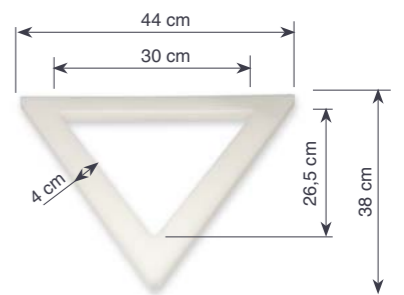



# Escurridores

INOX  
18/10  
Dishwasher



**Escurridor Inox**  
Passoire · Abtropfschale  
Straine · Escorredor

Ref	€	Ø (cm)	h (cm)	U.Venta
62732	18,50	22	8	1
62736	22,00	26	10	1

- Escurridor fabricado en acero inoxidable 18/10 de máxima calidad.
- Multifunción; diseñado para escurrir, colar y tamizar.
- Ideal para lavar todo tipo de verduras y frutas, colar pasta o arroz, etc.
- Se adapta a todo tipo de ollas, cacerolas, cazos, etc.
- Las asas laterales de acero inoxidable le otorgan robustez y firmeza y están diseñadas para un agarre cómodo y seguro.
- 100% apilable.
- Apto para lavavajillas.

- Strainer made from top quality 18/10 stainless steel.
- Multifunctional: designed for sifting, draining, straining and sieving.
- Ideal for washing all kinds of vegetables and fruit, straining pasta or rice, etc.
- Fits all types of pots, pans, casseroles, saucepans, etc.
- Fitted with strong, sturdy stainless steel side handles for a comfortable, secure grip.
- 100% stackable.
- Dishwasher safe.

- Fabricado en silicona de gran calidad, libre de BPA.
- Resistente, ligero, flexible y cómodo de usar.
- Orificios en la base y paredes para una mayor eficiencia.
- Dos prácticas asas laterales y aro de refuerzo de acero para un mejor manejo y estabilidad.
- 100% plegable: diseñado para ahorrar espacio de almacenamiento en la cocina.
- Multifuncional: ideal para escurrir gran variedad de alimentos como pastas, verduras, frutas, etc.
- Fácil de limpiar, apto para el lavavajillas.

- Made of high quality silicone, BPA free.
- Durable, lightweight, flexible and comfortable to use.
- Holes in the base and walls for greater efficiency.
- Two practical side handles and steel reinforcement ring for better handling and stability.
- 100% foldable: designed to save storage space in the kitchen.
- Multifunctional: ideal for draining a wide variety of foods such as pasta, vegetables, fruit, etc.
- Easy to clean, dishwasher safe.



SI  
Silicone  
BPA free

**Escurridor plegable**  
Passoire Pliable · Zusammenklappbares Sieb  
Folding strainer · Escorredor dobrável

Ref	€	Ø (cm)	h (cm)	U.Venta
62884	14,80	24	10	1

new

new



## Escurridera con base

Passoire sur pied · Abtropfschüssel mit Fussreif  
Colander with stand · Escorredora com base

Ref	€	Ø (cm)	h (cm)	L	U.Venta
50332	222,70	32	18	9,5	1
50336	270,70	36	19	12,0	1
50340	317,10	40	21	14,5	1



## Escurridera cónica con base

Passoire conique sur pied · Abtropfschüssel  
Conical colander with stand · Escorredor cónico com base

Ref	€	Ø (cm)	h (cm)	L	U.Venta
50829	72,60	28	17	13,2	1
50833	79,70	32	20	14,5	1
50837	90,80	36	23	16,0	1
50841	98,30	40	26	18,0	1
50846	112,70	45	29	20,0	1
50851	128,20	50	33	22,0	1

garinox®



INOX

## Escurridera Garinox

Passoire · Abtropfschüssel  
Colander · Escorredor

Ref	€	Ø (cm)	L	U.Venta
14122	18,90	22	3,0	1
14125	23,20	25	5,0	1
14130	33,60	30	8,0	1

Malla metálica donde se depositan los alimentos  
Metal mesh where food is deposited

Agujeros · Holes  
1x1 cm



Recipiente donde se recoge el aceite sobrante  
Container where excess oil is collected

## Escurrefritos

Passoire a friture · Abtropfschüssel für Frittiertes  
Fry colander · Escorre-fritos

Ref	€	cm	h (cm)	U.Venta
50541	186,30	40x29	8,0	1
50551	219,70	50x39	8,0	1
50561	252,40	60x39	8,0	1

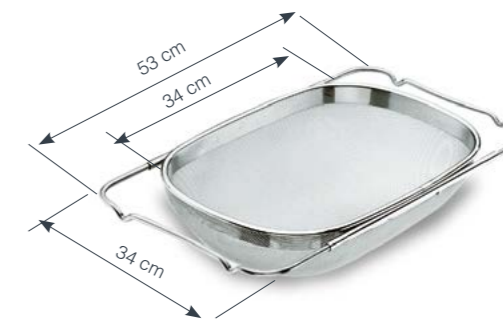

## Escurridor extensible

Passoire extensible pour l'évier · Spülbank-Sieb, ausziehbar  
Extendable sink strainer · Escorredor extensível para bancada

Ref	€	cm	U.Venta
62987	24,70	34-54x24	1

Ayuda a preparar rebozados perfectos  
Helps prepare perfect batters



Harina tamizada, para su recuperación  
Sifted flour, for its recovery

## Harinero

Tamis à farine à glissière · Mehlbehälter  
Flour bin mesh · Farinheiro

Ref	€	cm	h (cm)	U.Venta
50438	167,10	37x26,5	18	1
50450	172,50	50x26,5	18	1

# Embudos

INOX 18/10 Dishwasher

new



- Embudo dosificador fabricado en acero inoxidable.
- Excelente resistencia a la corrosión, los ácidos alimentarios y sales.
- Capacidad 1,25 L.
- Ideal para rellenar o decorar platos con salsas y cremas calientes y frías.
- Sistema de palanca para un caudal ajustable; práctico y preciso. Boquilla de salida de 8 mm.
- Mango con diseño ergonómico que permite el manejo con una sola mano.
- Incluye soporte de gran estabilidad.
- Fácil limpieza, apto para el lavavajillas.

- Entonnoir à decor fabriqué en acier inoxydable.
- Doté d'une excellente résistance à la corrosion, aux acides alimentaires et aux sels.
- Capacité : 1,25 L.
- Idéal pour remplir ou décorer des assiettes avec des sauces chaudes et froides.
- Système de piston pour un débit ajustable ; pratique et précis. Buse de sortie de 8 mm.
- Manche ergonomique qui permet de le manipuler d'une seule main.
- Inclut un support très stable.
- Nettoyage facile et compatible avec le lave-vaisselle.

- Automatic piston portionner funnel made of 18/10 stainless steel .
- Excellent resistance to corrosion, food acids and salt.
- 1.25 L capacity.
- Perfect for filling or decorating dishes with hot or cold sauces and cream.
- Its lever system for controlling the flow is practical and precise. 8 mm outlet nozzle.
- The ergonomic handle means it can be used with just one hand.
- Includes high stability base.
- It's easy cleaning and it's dishwasher safe.

INOX Dishwasher

## Dosificador embudo

Decor entonnoir · Doser dosiertrichter  
Portionner funnel · Dosificador funil

Ref	€	Ø (cm)	h(cm)	L	U.Venta
67151	22,10	13,5	26	1,25	1

## Ranura de desgasificación

Filtro  
Degassing groove. Filter



## Ranura de desgasificación

Filtro extraíble  
Degassing groove. Removable filter



## Embudo inox

Entonnoir · Trichter  
Funnel · Funil

Ref	€	Ø (cm)	U.Venta
62512	16,10	12	1
62516	23,30	16	1
62521	30,20	20	1
62524	33,80	24	1

Cuello ancho para verter con mayor rapidez en tarros/botellas sin riesgo de quemaduras  
Wide neck for faster pouring into jars / bottles without risk of burns



## Embudo con filtro

Entonnoir à filtre mobile · Trichter mit Sieb  
Funnel with movable filter · Funil com filtro

Ref	€	Ø (cm)	Ø inferior (cm)	U.Venta
62531	13,20	10	1,2	1
62513	15,40	12	1,5	1
62515	17,70	14	1,5	1



180°C Max Silicone BPA free

## Embudo expandible

Entonnoir extensible · Trichter  
Foldable funnel · Funil extensível

Ref	€	Ø (cm)	h(cm)	U.Venta
68085	6,10	8	10,5	1

## Embudo mermelada

Entonnoir à confiture · Mermeladentrichter  
Funnel for jam · Funil de congestionamento

Ref	€	Ø (cm)	Ø inferior (cm)	h(cm)	U.Venta
62517	10,30	13,5	6	6,5	1

# Pinceles

SI INOX 230°C Max Dishwasher BPA free

- Para cocina o repostería.
- Pinceles ideales para pincelar con aceites o salsas, marinar carnes o pescados, engrasar moldes, untar con aceite, huevo batido, almíbar, etc.
- No absorben olores ni sabores.

- Pour la cuisine ou la pâtisserie.
- Pinceaux parfaits pour badigeonner de l'huile ou des sauces, mariner des viandes ou des poissons, graisser des moules, étaler de l'huile, de l'œuf battu, du sirop, etc.
- N'absorbent ni les odeurs ni les goûts.

- For cooking or baking.
- Brushes ideal for brushing oils or sauces, marinating meat or fish, greasing baking tins, and basting with oil, egg, syrup, etc.
- Doesn't absorb smells or tastes.

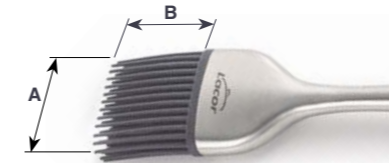

## Pincel de silicona Pro

Pinceau en silicone · Silikonpinsel  
Silicon brush · Pincel silicone

Ref	€	A (cm)	B (cm)	Largo (cm)	U.Venta
64418	11,10	4,0	4,0	22	1
64422	12,40	4,0	4,0	23	1

## Pincel Virola

Pinceau · Silikonpinsel  
Brush · Pincel

Ref	€	A (cm)	B (cm)	Largo (cm)	U.Venta
64430	4,40	2,8	5,0	23,0	1
64435	5,10	3,2	5,5	24,0	1
64440	5,30	3,8	5,5	24,5	1
65044	6,60	4,2	6,5	25,0	1
65050	7,90	4,7	6,5	26,0	1

Dimensiones reales · Real dimensions

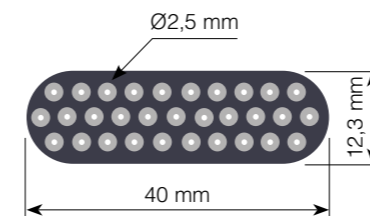

## Pincel de silicona

Pinceau en silicone · Silikonpinsel  
Silicon brush · Pincel de silicone

Ref	€	A (cm)	B (cm)	Largo (cm)	U.Venta
64441	6,90	5,8	3,4	23	1

SI HAYA 230°C Max LFGFB Food Grade Silicone

## Pincel de silicona Mix

Pinceau de cuisine en silicone · Silikonpinsel  
Silicone brush · Pincel de silicone

Ref	€	A (cm)	B (cm)	Largo (cm)	U.Venta
64431	7,40	3,8	4,0	24	12

Ref	€	A (cm)	B (cm)	Largo (cm)	U.Venta
68196	4,20	5,5	3,1	24,5	1

# Hervidores

INOX 18/10 Dishwasher

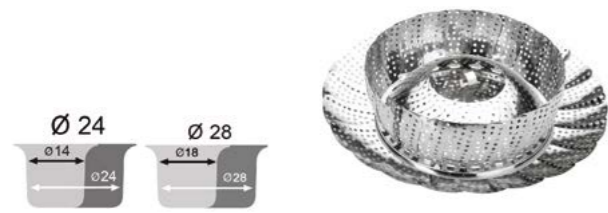

## Hervidor extensible Inox

Panier marguerite extensible · Kocher, ausdehnbar, Rostfrei  
Extendable steamer · Grelha extensível

Ref	€	Ø (cm)	U.Venta
60349	6,90	24	12
60348	10,10	28	12

## Cuece especias

Diffuseur épices · Kräterkochsieb  
Spice cooker · Cozedor de especiarias

Ref	€	Ø (cm)	h(cm)	U.Venta
62958	12,60	4	15,4	1

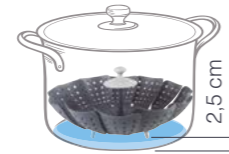

- Fabricado en polipropileno de máxima calidad, altamente resistente al calor, libre de BPA.
- Diseñado para cocinar los alimentos al vapor preservando todos sus nutrientes y vitaminas.
- Se adapta a diferentes tamaños de ollas gracias a sus hojas plegables.
- Almacenaje compacto; se pliega fácilmente y ocupa poco espacio.
- Tres pies antideslizantes de 2,5 cm de altura que no rayan la base de la olla.
- Pomo para una extracción segura.

- It's made of top quality BPA free polypropylene with high heat resistance.
- It's designed for steaming food and preserving all the vitamins and nutrients.
- It can fit different sizes of pots because of its collapsible leaves.
- Compact Storage: easy to fold up and doesn't take up a lot of space.
- It has three 2.5 cm tall non-slip feet that won't scratch the bottom of the pot
- Knob for safe and secure removal.

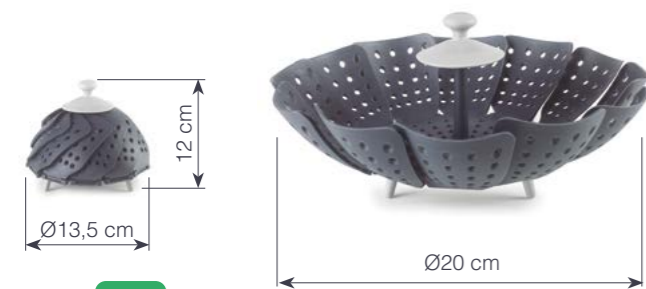

PP Polypropylene BPA free

## Hervidor extensible Flor

Panier marguerite extensible · Kocher, ausdehnbar, Rostfrei  
Extendable steamer · Grelha extensível

Ref	€	Ø (cm)	h(cm)	U.Venta
60288	8,20	13,5-26	12	1



## Cacerola vapor

Panier vapeur · Dampfkoch-Aussatz o/Untertopf  
Steam casserole · Caçarola a vapor

Ref	€	Ø (cm)	h(cm)	e (mm)	U.Venta
50428	60,50	28	11,0	0,8	1
50432	66,80	32	12,5	0,8	1



## Hervidor pescado

Poissonniere avec grille · Fischkochkessel mit Einsatz  
Fish kettle with grill · Peixeira

Ref	€	cm	h(cm)	e (mm)	L	U.Venta
50440	105,60	40x19	11	0,8	10,05	1
50445	111,50	50x17	11	0,8	13,80	1
50460	145,60	60x19	11	0,8	20,80	1



# Huevo collection

INOX 18/10 Dishwasher



## Separador de claras

Séparateur à oeuf · Eier-Separator  
Eggs separator · Separador de ovos

Ref	€	h(cm)	U.Venta
61608	8,00	3,0	6



## Soporte huevo Ovum

Support d'oeufs · Eierbecher  
Egg stand · Suporte de ovo

Ref	€	Ø (cm)	h(cm)	U.Venta
68285	3,00	4,5	5	6



SI Silicone BPA free

## Molde huevo

Moule à oeufs · Eierform  
Egg mould · Molde ovo

Ref	€	cm	h(cm)	U.Venta
A 68082	6,30	10,5x10,5	2,0	1
B 68080	6,30	Ø10	2,0	1

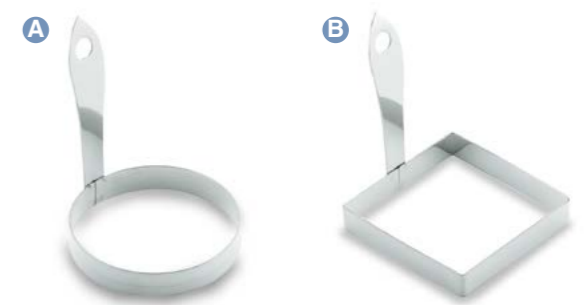

INOX

## Molde huevo inox

Moule à oeufs-sandwich · Eier-/Sandwichring  
Mould for egg-sandwich · Molde ovo-Sandwich

Ref	€	cm	U.Venta
A 68005	3,30	Ø8,5	12
B 68006	3,30	8,5x8,5	12

# Garras de oso

INOX BAQUELITA  
Bakelite Dishwasher

- Fabricadas en acero inoxidable de máxima calidad.
- Diseñadas para desmenuzar y manipular carnes hechas al horno o barbacoa, como pollo, carne de vacuno, pavo, aves, jamón, etc.
- Puntas afiladas para manipular la carne sin esfuerzo. Forma curvada para un mejor agarre y mayor comodidad.
- Mangos ergonómicos de baquelita resistentes al calor, 100% seguros.
- Multifuncional: desmenuza y traslada la carne, facilita la sujeción para cortes con cuchillo, remueve las ensaladas o pastas, etc.
- Fácil de limpiar. Aptas para el lavavajillas.

- Fabriqué en acier inoxydable de qualité maximale.
- Conçu pour s'effondrer et manipuler la viande de viande, comme le poulet, le bœuf, la dinde, les oiseaux, le jambon, etc.
- Des conseils pointus pour gérer la viande sans effort. Forme incurvée pour une meilleure adhérence et un plus grand confort.
- Mangues de baquelite ergonomiques résistantes à la chaleur, 100% d'assurance.
- Multifonctionnel: s'effondre et déplace la viande, facilite la fixation des coupures de couteau, retirer les salades ou les pâtes, etc.
- Facile à nettoyer. Convient au lave-vaisselle.

- Manufactured in maximum quality stainless steel.
- Designed to crumble and handle meat -made meats, such as chicken, beef, turkey, birds, ham, etc.
- Sharp tips to handle meat effortlessly. Curved form for a better grip and greater comfort.
- Ergonomic bakelite mangoes resistant to heat, 100% insurance.
- Multifunctional: crumbles and moves the meat, facilitates the fastening for knife cuts, remove salads or pasta, etc.
- Easy to clean. Suitable for dishwasher.

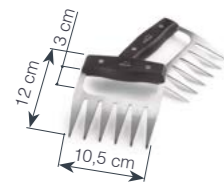

**Garras de oso**  
Griffes à viande · Fleisch Bärenkrallen  
Bear claws for meat · Garras de urso para carne

Ref	€	cm	U.Venta
38015	13,00	10,5x12	1



**Manipula carnes. Desmenuza carnes**  
Manipulate meat. Crumble meats

# Pasapurés

INOX 18/10  
Dishwasher



**Pasapurés**  
Presse-Puree · Passiergerät  
Potato mashing machine · Passa-puré professional

	Ref	€	Ø (cm)	Diámetro disco (cm)	Cuchillas	L	U.Venta
A	60026	127,60	26	16,5	2	5,0	1
	60031	133,40	32	16,5	2	8,0	1
B	60030	84,60	30	16,5	2	3,5	1
C	60048	56,60	18	10,5	3	0,7	1
	60027	74,40	24	13,5	3	1,5	1
D	60021	57,40	20	11,5	2	1,5	1



# Morteros

GRANITO  
Granite BPA free

- Fabricados en granito de calidad premium.
- Interior no poroso, permite extraer los aceites naturales de las hierbas y especias.
- El diseño de la mano permite maniobrar con facilidad y con poco esfuerzo.
- Pesado y bien balanceado.

- Composé de granit de qualité supérieure.
- Intérieur non poreux permettant d'extraire les huiles essentielles des herbes et épices.
- La conception de la main facilite les manœuvres et réduit les efforts.
- Lourd et bien équilibré.

- Manufactured from premium quality granite.
- Interior not porous allowing extracting natural oils from herbs and spices.
- The design of the hand allows easy manoeuvres with little effort.
- Heavy and well balanced.



PE  
Polyéthilène BPA free

**Mortero White**  
Mortier · Mörser  
Mortar · Almofariz

Ref	€	Ø (cm)	U.Venta
60403	165,10	18	1

**Mortero con mano de granito**  
Mortier et pilon en granit · Mörser und Stößel aus Granit  
Granite mortar and pestles · Argamassa e pilão do granito

	Ref	€	Ø (cm)	h(cm)	ml	U.Venta
A	60512	26,50	12	8	250	1
B	60514	30,90	14	10	375	1
C	60516	32,20	16	12	600	1
	60517	25,70	10,5	7,5	225	1
D	60518	26,10	12	12,0	365	1

**Mano mortero**  
Poussoir à mortier · Stößel  
Pestle · Pilão p/almofariz

Ref	€	Ø (cm)	Largo (cm)	U.Venta
60401	40,30	Ø4,8	25	1

# Prensadores

INOX  
18/10  
Dishwasher



- Fabricado en acero inoxidable 18/10 de alta calidad y gran resistencia.
- Tritura sin esfuerzo cualquier alimento cocinado previamente o de textura blanda.
- Ideal para preparar puré de patata, tomate, calabaza, plátano, etc.
- Superficie de prensado diseñada para conseguir un acabado homogéneo.
- No transmite olores ni sabores a los alimentos.

- Fabriqué en acier inoxydable 18/10 de grande qualité et d'une résistance maximale.
- Triture sans effort tout aliment préalablement cuit ou à texture molle.
- Idéal pour préparer de la purée de pomme de terre, de courge, de banane, etc.
- Surface de pressage conçue pour obtenir un résultat homogène.
- Ne transmet ni odeurs ni goûts aux aliments.

- Made of top quality, high resistance 18/10 stainless steel.
- Easily mashes any pre-cooked or soft-textured foods.
- Ideal for mashing potatoes, tomatoes, pumpkin, bananas, etc.
- Mashing surface designed for even mashing, giving perfect results.
- Does not transmit odours or flavours.
- Smooth round handle for a comfortable and secure grip.



## Prensador de patatas

Presse-purée · Kartoffelpresse  
Potato masher · Prensa-batatas

Ref	€	cm	h(cm)	U.Venta
A 62892	19,90	10,5x8,5	24	1
B 62896	18,40	ø11,6	45,5	1
C 62897	8,70	11x7,5	17,5	1



## Prensa patatas

Presse-pomme de terre · Kartoffelpresse  
Potato press · Esmaga-batatas

Ref	€	cm	U.Venta
62902	35,80	9x28x11	1

## Molde empanadillas

Moule à chaussons · Pastetenformen  
Dumpling mould · Forma para salgados

Ref	€	Ø (cm)	U.Venta
68101	21,50	10	1
68102	23,50	12	1

## Pica y lamina

Chop and slice



## Accesorio para eliminar los restos

Accessory for eliminating the remains



## Prensa ajos y laminador

Presse ail coupe · Knoblauchpresse, Schneider  
Garlic press and slicer · Esmaga-alhos y laminador

Ref	€	Largo (cm)	U.Venta
60387	27,10	20	1

- Diseñado para triturar y cortar en cubos los ajos volteando los mangos.
- Gran capacidad de carga (varios dientes a la vez).
- Mecanismo de presión perfecto para minimizar el esfuerzo.
- Robusto, cómodo, rápido y fácil de usar.
- Mangos antideslizantes y ergonómicos para un agarre seguro.
- Garantiza resultados perfectos.
- Incluye accesorio para una fácil limpieza

- Conçu pour écraser et couper l'ail en dés en tournant les poignées.
- Grande capacité de charge (plusieurs gousses en même temps).
- Mécanisme de pression parfait pour minimiser l'effort.
- Robuste, confortable, rapide et facile à utiliser.
- Poignées ergonomiques antidérapantes pour une bonne préhension.
- Résultats parfaits garantis.
- Comprend un accessoire de nettoyage

- Designed to chop and cube garlic by turning the handles.
- High capacity (several teeth at once).
- The pressure mechanism is perfect for minimising effort.
- Strong, comfortable and fast and easy to use.
- The non-slip and ergonomic handles make for a sturdy grip.
- Perfect results guaranteed.
- Includes cleaning accessory

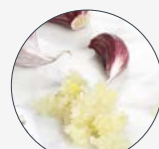

Triturar



Cubos



2 en 1

ZAMAK Zinc Alloy  
ABS Plastic  
INOX

## Prensa ajos Dual

Presse ail coupe · Knoblauchpresse  
Garlic press · Esmaga-alhos

Ref	€	h(cm)	U.Venta
60277	22,80	16	1



# Prensa hamburguesas



Separadores · Separators



- Fabricado en aluminio fundido anodizado y acero inoxidable 18/10.
- Firme, robusto y resistente.
- Diseñado para un uso profesional intensivo y continuado; ideal para carnicerías, hamburgueserías, restaurantes, etc.
- Diámetro de la hamburguesa: Ø130 mm. Forma uniforme.
- Funcionamiento manual: mecanismo de palanca.
- Mecanismo de extracción rápida: extrae la hamburguesa con total facilidad.
- Depósito para almacenar las hojas separadoras y tenerlas a mano mientras se elaboran las hamburguesas.
- Pies de goma antideslizantes: máxima estabilidad durante el uso.
- Incluye 500 unidades de papel antiadherente perforado de Ø13 cm (evita que la carne se pegue a la hora de retirar el papel).

- Fabriqué en fonte d'aluminium anodisée et en acier inoxydable 18/10.
- Stable, robuste et résistante.
- Conçue pour un usage professionnel intensif et continu ; idéale pour les boucheries, les établissements de hamburgers, les restaurants, etc.
- Diamètre du steak haché : Ø130 mm. Forme uniforme.
- Fonctionnement manuel : mécanisme à levier.
- Mécanisme d'extraction rapide : extrait le steak haché avec une grande facilité.
- Compartiment pour ranger les feuilles de séparation et les avoir à portée de main pendant l'élaboration des steaks hachés.
- Pieds en caoutchouc antidérapant : stabilité maximale pendant l'utilisation.
- Inclut 500 unités de papier antiadhésif perforé de Ø13 cm (évite que la viande colle lors du retrait du papier).

- Made of anodized cast aluminium and 18/10 stainless steel.
- Rigid, robust and strong.
- Designed for intensive continuous professional use, and perfect for butcher shops, hamburger and other restaurants, etc.
- Patty diameter Ø130 mm consistent shape.
- Manual Operation: lever mechanism.
- Quick Release Mechanism: Patties can be removed very easily.
- Holder for storing separator sheets and keeping them handy when you're making patties.
- Non-slip Rubber Feet: Maximum stability during use.
- Includes 500 Ø13 cm sheets of non-stick paper with holes to keep the meat from sticking when the paper is removed.

AL FUNDIDO INOX  
Aluminium Cast 18/10

## Prensa hamburguesas profesional

Presse à hamburguers · Hamburger-Formen  
Hamburg presser · Moldes para hamburguesas

Ref	€	Hamburguesa Ø (cm)	U.Venta
60226	223,70	10	1
A R60226A	9,40	10	6
60227	243,70	13	1
A R60227A	9,90	13	6



AL FUNDIDO HAYA  
Aluminium Cast Wood

## Molde para hamburguesas Press

Presse à hamburguers · Hamburger-Formen  
Hamburg presser · Moldes para hamburguesa

Ref	€	Ø (cm)	U.Venta
60258	15,00	11,5x7,5	1
R60258A	1,50	11	1



ABS Plastic BPA free

## Molde para hamburguesas Multi

Presse à hamburguers · Hamburger-Formen  
Hamburg presser · Moldes para hamburguesa

Ref	€	Ø (cm)	U.Venta
60259	7,50	12,5x6	1
R60259A	1,40	10	1



- Molde de aleación de aluminio fundido de gran calidad con recubrimiento antiadherente.
- Pomo de madera desmontable y ergonómico, permite una distribución uniforme de la presión para crear hamburguesas caseras de carne, vegetarianas o veganas.
- Perfectas en proporción y consistencia.
- Superficie interior acanalada; proporciona un aspecto profesional.
- Incluye 60 unidades de papel antiadherente de Ø11 cm.
- Fácil de limpiar.

- Moule d'alliage en aluminium fondu de haute qualité avec revêtement non stick.
- Le bouton de bois amovible et ergonomique permet une répartition uniforme de pression pour créer des hamburgers faits maison de viande, végétariens ou végétaliens.
- Parfait en proportion et en cohérence.
- Surface intérieure srangée; Il fournit un aspect professionnel.
- Comprend 60 unités inconnues de UNK de Ø11 cm.
- Facile à nettoyer.

- High quality molten aluminum alloy mold with non -stick coating.
- Removable and ergonomic wood knob, allows a uniform distribution of pressure to create homemade hamburgers of meat, vegetarian or vegan.
- Perfect in proportion and consistency.
- Stranged interior surface; It provides a professional aspect.
- Includes 60 unk's unknown units of Ø11 cm.
- Easy to clean.

- Fabricado en plástico ABS de alta calidad y durabilidad. Libre de BPA.
- Compuesto por 6 piezas totalmente desmontables.
- Versátil: ideal para preparar y rellenar todo tipo de hamburguesas.
- Base extraíble acanalada para facilitar la extracción de la hamburguesa.
- Compacto: se guarda en una sola pieza.
- Práctico y muy fácil de usar.
- Medidas (mm): hamburguesa grande Ø10x3 cm / mini Ø6,5x2 cm.
- Incluye 60 unidades de papel antiadherente de Ø10 cm.
- Fácil de limpiar. Apto para el lavavajillas.

- Fabriqué en plastique ABS de haute qualité et durabilité. Sans BPA.
- Composé de 6 pièces totalement amovibles.
- Polyvyle: Idéal pour préparer et remplir toutes sortes de hamburgers.
- Base amovible pour faciliter l'extraction du hamburger.
- Compact: il est enregistré en une seule pièce.
- Pratique et très facile à utiliser.
- Mesures (mm): grand hamburger Ø10x3 cm / mini Ø6,5x2 cm.
- Comprend 60 unités de papier antiadhérentes Unkly Ø10 cm.
- Facile à nettoyer. Apte pour le lave-vaisselle.



## Prensador carne Magma

Presse à steak · Fleischpresse  
Meat press · Prensador de carne

Ref	€	cm	h(cm)	U.Venta
A 25862	15,00	Ø17,5	8,0	1
B 25863	18,40	23x11	8,0	1

FE FUNDIDO  
Iron Cast

- Prensador de carne fabricado en hierro fundido de gran calidad y resistente a altas temperaturas.
- Diseñado con una superficie acanalada para dar a tus carnes, hamburguesas, smash burgers, sándwiches, bistec, etc. marcas de parrilla perfectas.
- Mango ergonómico de madera natural, proporciona un agarre cómodo y seguro.

- Presse à steak fabriquée en fonte de grande qualité et résistante à de hautes températures.
- Conçue avec une surface cannelée pour donner à vos viandes (steaks hachés, smash burgers, sandwichs, beefsteaks, etc.) des marques de grill parfaites.
- Manche ergonomique en bois naturel, qui confère une prise en main pratique et sûre.

- Meat press made of high quality cast iron. Resistant to high temperatures.
- Designed with a ribbed surface to give your meat, burgers, smash burgers, sandwichs, steaks, etc. perfect grill marks.
- Ergonomic natural wood handle for a comfortable, secure grip.



# Ablandacarnes

INOX 18/10 Dishwasher



- **Sólida, robusta y especialmente pesada (734 g) para ablandar, aplanar y ensanchar fácilmente todo tipo de carnes.**
- **Gran superficie de aplastado (espesor de 12 mm.)**
- **Mango robusto ergonómico para un fácil manejo con práctica presilla para colgar.**
- **Higiénica e inodora, no absorbe los olores de los alimentos.**

- Solide, extrêmement robuste et spécialement conçu pour attendrir, aplatir et élargir facilement tout type de viande.
- Grande surface de travail avec une épaisseur de 12 mm.
- Manche robuste et ergonomique pour une prise en main facile et un crochet pratique pour le suspendre.
- Hygiénique et inodore, il n'absorbe pas les odeurs des aliments

- Solid, extremely robust and specially designed (734 g) to easily tenderise, flatten and widen all types of meat.
- Large 12 mm thick flattening surface.
- Sturdy, ergonomic handle for firm grip and easy handling.
- Features a practical hanging eye.
- Hygienic and odourless: does not absorb odours or flavours

## Maza ablandacarne

Attendrisseur de viande · Fleischhammer  
Meat mallet · Maço para amciar carne

Ref	€	cm	h(cm)	U.Venta
61251	25,80	27x8	11,0	1

**Liso para reducir el grosor de la carne.**  
**Rugoso para ablandar y para que penetre mejor los adobos**  
Smooth side, to reduce the thickness of the meat.  
Rough side for softening and better marinade penetration



Mango ergonómico y antideslizante  
Ergonomic non-slip handle



INOX

## Ablandacarne Inox

Attendrisseur à viande en Inox · Fleischklopf, Edelstahl  
St. steel meat tenderizer · Ablandacarne Inóx

Ref	€	cm	U.Venta
60432	38,70	12x2	1

- **48 cuchillas extremadamente afiladas fabricadas en acero inoxidable.**
- **Las cuchillas crean pequeños canales térmicos dentro de la carne, permitiendo que el calor penetre y se distribuya uniformemente.**
- **Ideal para preparar todo tipo de carnes para que queden más jugosas, sabrosas y blandas.**
- **Las cuchillas se retraen automáticamente al dejar de presionar.**
- **Mango ergonómico antideslizante, garantiza un agarre seguro y eficiente.**
- **Diseño seguro con cubierta protectora.**

- 48 lames extrêmement aiguës fabriquées en acier inoxydable de grande qualité.
- Les lames créent de petits canaux thermiques dans la viande, permettant ainsi à la chaleur de pénétrer et de se répandre uniformément.
- Idéal pour préparer tout type de viandes afin qu'elles soient juteuses, savoureuses et tendres.
- Les lames se rétractent automatiquement dès que l'on cesse d'appuyer sur l'appareil.
- Manche ergonomique antidérapant qui garantit une prise en main sûre et efficace.
- Conception sûre avec couvercle de protection.

- 48 extremely sharp high quality stainless steel blades.
- The blades create small heat channels in the meat, ensuring even heat absorption and distribution.
- Ideal for cooking all kinds of meat for more succulent, tender and juicy dishes.
- The blades retract automatically when you stop pressing.
- Ergonomic, non-slip handle for a comfortable, safe grip.
- Safe design with protective cover.

## Ablandacarne Black

Attendrisseur de viande · Fleischhammer  
Meat mallet · Maço para amciar carne

Ref	€	Cuchilla (cm)	U.Venta
61250	9,10	6x3	1



# Exprimidores manuales

INOX 18/10 Dishwasher



## Exprimidor Inox

Presse citron manuel · Manuelle zitronenpresse  
Manual reamer · Espremedor manual

Ref	€	Ø (cm)	L	U.Venta
62952	18,10	10	0,15	6
62912	21,20	12	0,20	6



## Exprimidor manual inox

Presse-ruits manuel · Manuelle fruchtpresse  
Manual squeezer · Espremedor de sumos

Ref	€	cm	h(cm)	U.Venta
63914	55,20	15x19	39,0	1

## Exprimidor manual Flor

Presse citron manuel · Manuelle zitronenpresse  
Manual reamer · Espremedor manual

Ref	€	Ø (cm)	h(cm)	U.Venta
63912	13,00	4,5	16	1



## Exprimidor limón

Presse-citron · Zitruspresse  
Lemon squeezer · Espremedor de limão

Ref	€	cm	U.Venta
62946	12,00	12 x 2,5 x 5,5	1

PP Polypropylene BPA free



## Exprimidor manual mini

Presse citron manuel · Manuelle zitronenpresse  
Manual reamer · Espremedor manual

Ref	€	cm	h(cm)	ml	U.Venta
68181	6,60	10x9,5	8,5	70	1



Inox 18/10

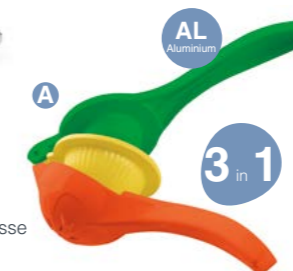

AL Aluminum

3 in 1

## Exprimidor manual

Presse citron manuel · Manuelle zitronenpresse  
Manual reamer · Espremedor manual

Ref	€	Largo (cm)	U.Venta
A 63915	11,40	22	1
B 68182	26,50	22	1

ABS Plastic BPA free



## Exprimidor manual con jarra medidora

Presse citron manuel · Manuelle zitronenpresse  
Manual reamer · Espremedor manual

Ref	€	cm	h(cm)	L	U.Venta
67134	7,50	18,5 x 11	15	0,5	1

- **Excelente resistencia a la corrosión; no se oxida o reacciona a los jugos de los cítricos.**
- **Ideales para exprimir limas, limones y naranjas.**
- **Superficie acanalada para extraer el máximo jugo.**
- **Mango ergonómico para un fácil exprimido y un menor esfuerzo.**
- **Apto para el lavavajillas.**

- It has excellent corrosion resistance and does not rust or react to citrus juice.
- It's perfect for squeezing limes, lemons and oranges.
- Grooved surface for maximum juice extraction.
- It has an ergonomic handle to make squeezing juice easy and almost effortless.
- Dishwasher safe.



**Ideal para limas, limones, naranjas e incluso pomelos**  
Ideal for limes, lemons, oranges and even grapefruit



## Colección Smart



- **Bomba de vacío inalámbrica. Práctica y silenciosa.**
- **Extrae el aire en segundos con solo pulsar un botón.**
- **Capacidad de succión de 2,5L/min.**
- **Los alimentos se mantienen frescos durante más tiempo.**
- **El proceso de vacío se detiene automáticamente al crear un vacío adecuado.**
- **Se carga a través del cable USB (incluido).**
- **Batería de iones de litio de larga duración.**
- **Diseño elegante, moderno y compacto.**

- **Pompe à vide sans fil. Pratique et silencieuse.**
- **Extrait l'air en quelques secondes en appuyant sur un simple bouton.**
- **Capacité d'aspiration de 2,5L/min.**
- **Les aliments restent frais plus longtemps.**
- **Le processus de vidage s'arrête automatiquement dès que le vide adéquat est obtenu.**
- **Rechargeable par câble USB (inclus).**
- **Batterie lithium-ion de longue durée.**
- **Design élégant, moderne et compact.**

- **Wireless vacuum pump. Practical and quiet.**
- **Extracts air in seconds with the push of a button**
- **2.5 L/min suction capacity**
- **Food stays fresh longer**
- **The vacuum process stops automatically when a suitable vacuum has been created.**
- **It is charged with a USB cable (included).**
- **Long-lasting lithium-ion battery**
- **Elegant, modern and compact design. Saves storage space.**

### Bomba de vacío Smart

Pompe à vide · Vakuumpumpe  
Vacuum pump · Bomba de vacío

Ref	€	Ø (cm)	h(cm)	U.Venta
69690	41,10	4,3	16,3	1



### Bomba de vacío + 4 recipientes

Ensemble de pompe à vide + 4 récipients ·  
Vakuumpumpsatz + 4 Behälter  
Bomba de vacío + 4 recipientes ·  
Conjunto de bomba de vacío + 4 recipientes

Ref	€	U.Venta
69698	84,50	1



**100% herméticos**  
100% hermetic

**Válvula especial para vacío**  
Special vacuum valve

**Apilables**  
Stackable



### Recipiente Smart

Récipient · Behälter  
Container · Recipiente

Ref	€	cm	U.Venta	ml	h(cm)
69691	7,00	15x11	1	550	6,0
69692	9,40	18,8x13	1	1200	8,0
69693	12,40	22,5x15,5	1	1500	7,0
69694	14,40	22,5x15,5	1	2300	10,0

**Válvula de vacío hermética**  
Hermetic vacuum valve

**Cierre tipo Zip doble**  
Double zip fastener

**Zona de identificación**  
Identification zone

### Bolsas Smart

Sacs · Taschen  
Bags · Sacos

Ref	€	cm	U.Venta	Piezas
69695	7,50	20x23	1	10
69696	10,40	26x35	1	10
69697	8,60	30x49	1	5
69699	10,90	20x23 (5)	1	12
		26x35 (5)		
		30x49 (2)		

new

## Contenedor de alimentos



PE ASA BPA free  
Polyethylene Acrylic

**Contenedor de alimentos**  
Boîte à condiments · Gewürzkasten  
Condiments holder · Caixa condimentos

Ref	€	cm	ml	Compartimentos	U.Venta
61133	28,50	50x16x9	1000	3	1
61134	28,50	50x16x9	750	4	1
61135	28,50	50x16x9	600	5	1
61136	28,50	50x16x9	450	6	1



## Organizadores Organizer

PET ABS SI BPA free  
Plastic Plastic Silicone



- **Diseñado para almacenar todo tipo de alimentos secos.**
- **Tapa hermética con cierre de silicona; mantiene los alimentos frescos durante más tiempo.**
- **Tapa con mecanismo de cierre y apertura patentado que permite su manipulación con una sola mano.**
- **Modular y apilable. Ahorra espacio en la cocina.**
- **Recipiente fabricado en plástico resistente, 100% libre de BPA.**

- Conçu pour ranger tout type d'aliments secs.
- Couvercle hermétique avec fermeture en silicone ; maintient les aliments frais plus longtemps.
- Couvercle avec mécanisme d'ouverture et fermeture breveté qui permet une manipulation avec une seule main.
- Modulable et empilable. Gain de place dans la cuisine.

- Recipient fabriqué en plastique résistant, 100% sans BPA
- Designed for storing all types of dry food.
- Airtight lid with silicone seal to keep food fresh for longer.
- Lid with patented opening and closing mechanism for easy one-handed operation.
- Modular and stackable for saving space in the kitchen.
- Container made of resistant BPA-free plastic

### Organizadores Organizer

Boîtes · Boxen oder behälter  
Canisters · Botes

	Ref	€	cm	h(cm)	L	U.Venta
A	64624	5,60	10,5x10,5	8,0	0,4	1
B	64621	7,10	10,5x10,5	16,0	1,0	1
C	64625	8,40	10,5x10,5	23,5	1,5	1
D	64627	6,60	10,5x15,5	8,00	0,7	1
E	64626	8,40	10,5x15,5	16,00	1,6	1





## Máquina laminadora de pasta

INOX

- Rodillos de acero inoxidable, permiten conseguir hasta 9 grosores de pasta.
- Posibilidad del accesorio para raviolis.

- Rouleaux en acier inoxydable, permettent jusqu'à 9 épaisseurs de pâte.
- Possibilité d'accessoires de raviolis.

- Stainless steel rollers, allow up to 9 paste thickness.
- Possibility of raviolis accessory.



**Regulador de grosor de pasta (3,4 mm - 0,93 mm)**  
Pasta thickness Regulator (3,4 mm - 0,93 mm)



**Solo puede utilizarse en la máquina de 145 mm (Ref: 60390)**  
Only can be used in the machine of 145 mm (Ref: 60390)

**Accesorios para ravioli**  
Accessoire pour raviolis · Zubehör für Ravioli  
Ravioli maker · Accesorio para raviolis

	Ref	€	Medidas ravioli	U.Venta
A	60497	22,40	45x45 mm	1
B	60498	22,40	30x30 mm	1



**Máquina laminadora de pasta**  
Machine Lamineuse à pâte · Pastamaschine  
Pasta Machine Slicer · Maquina de Pasta

	Ref	€	Espesor corte mm	U.Venta
A	60390	46,60	0,2 - 3 mm	145
B	60391	86,10	0,2 - 3 mm	260

INOX

**Medidor de pasta inox**  
Mesureur pour pâtes en Inox · Spaghetti-Mass Rostfrei  
St steel pasta measurer · Medidor para macarrao en Inóx

	Ref	€	cm	U.Venta
A	62942	3,40	18	1
B	62943	4,70	11x9	1



## Embutidora

INOX 18/10  
Dishwasher

Incluye boquillas  
Includes nozzles

Ø38 mm Ø32 mm Ø22 mm Ø16 mm



### Máquina embutidora

Pousoir manuel · Manuelle Wurstfüller  
Manual stuffer · Máquina para encher salsichas manual

Ref	€	h(cm)	Cilindro (cm)	L	U.Venta
60253	286,30	52,3	Ø14 x 20	3	1
60255	328,20	64,7	Ø14 x 32	5	1
60257	378,50	78,0	Ø14 x 46	7	1
60251	435,90	60,5	Ø22 x 27	10	1

- Fabricada en acero inoxidable 18/10 de gran calidad.
- Rápida y eficaz: diseñada para elaborar diferentes tipos de embutidos como chorizos, salchichas, butifarras, etc.
- Gran capacidad: ideal para carnicerías, restaurantes y cocinas industriales.
- Doble velocidad (lenta/rápida) gracias a un mecanismo de dos marchas accionado por rodamiento.
- Incluye 4 boquillas de llenado de acero inoxidable: Ø38 mm, Ø32 mm, Ø22 mm y Ø16 mm.
- Tuerca de unión de fácil manejo que permite cambiar rápidamente las boquillas de llenado.
- La tolva se puede inclinar a 90 grados para llenar, limpiar y desmontar.

- Fabriqué en acier inoxydable 18/10 de haute qualité.
- Rapide et efficace: conçu pour faire différents types de saucisses telles que les saucisses, les saucisses, les butifarras, etc.
- Grande capacité: idéal pour les bouchers, les restaurants et les cuisines industrielles.
- Double vitesse (lent / rapide) grâce à un mécanisme à deux vitesses entraîné par le roulement.
- Comprend 4 buses de remplissage en acier inoxydable: Ø38 mm, Ø32 mm, Ø22 mm et Ø16 mm.
- Écrou de liaison de manipulation facile qui vous permet de changer rapidement les buses de remplissage.
- La trémie peut être inclinée à 90 degrés pour remplir, nettoyer et se désassembler.

- Made of stainless steel 18/10 of high quality.
- Fast and effective: designed to make different types of sausages such as sausages, sausages, butifarras, etc.
- Great capacity: ideal for butchers, restaurants and industrial kitchens.
- Double speed (slow/fast) thanks to a two-speed mechanism driven by bearing.
- Includes 4 stainless steel filling nozzles: Ø38 mm, Ø32 mm, Ø22 mm and Ø16 mm.
- Easy handling binding nut that allows you to quickly change filling nozzles.
- The hopper can be tilted at 90 degrees to fill, clean and disassemble.

## Clipadora

INOX



**Regulación de presión**  
Pressure adjustment

**Clipadora**  
Clippeuse d'aliments · Lebensmittelacker  
Food clipping machine · Agrafadora para alimentos

Ref	€	cm	h(cm)	U.Venta
61200	307,70	37x15	58,5	1
61201	22,70	4,6 - 6	-	1

Grapas (4000 unid.)  
Staples (set of 4000)

- Fabricada en acero inoxidable de máxima calidad.
- Diseñada para grapar embutidos, mallas de fruta, bolsas, etc. con el mínimo esfuerzo.
- Accionamiento manual fácil y muy cómodo.
- Sistema de apoyo de zamak macizo que garantiza una estabilidad máxima.
- Capacidad de grapas: 200 unidades (ref: 61201 - no incluidas).
- Fácil de limpiar.

- Fabriqué en acier inoxydable de qualité maximale.
- Conçu pour pomper des saucisses, des mailles de fruits, des sacs, etc. Avec l'effort minimum.
- Drive manuel facile et très confortable.
- Système de soutien Zamak solide qui garantit une stabilité maximale.
- Capacité temporaire: 200 unités (Réf: 61201 - Non incluse).
- Facile à nettoyer.

- Manufactured in maximum quality stainless steel.
- Designed to pump sausages, fruit meshes, bags, etc. With the minimum effort.
- Easy and very comfortable manual drive.
- Solid Zamak Support System that guarantees a maximum stability.
- Temporary capacity: 200 units (Ref: 61201 - Not included).
- Easy to clean.

**GRAPAS · STAPLES**  
Ref: 61201  
No incluidas · Not included



# Centrifugadoras



PP  
Polypropylene

Para uso profesional, sencillo y eficaz  
For professional use, simple and efficient



## Centrifugadora Profesional

Essereuse à salade · Salatschleuder  
Salad spinner drier · Centrifugadora profesional

Ref	€	Ø (cm)	h (cm)	L	U.Venta
61420	207,90	32	33	12,0	1
61425	231,80	42	40	25,0	1

Article non vendu en France



PP SAN  
Polypropylene Plastic

## Centrifugadora White

Essoreuse · Salatschleuder  
Spinner · Centrifugadora

Ref	€	Ø (cm)	h (cm)	L	U.Venta
61403	30,40	26	20,0	5,00	1



## Centrifugadora Klein

Essoreuse · Salatschleuder  
Spinner · Centrifugadora

Ref	€	Ø (cm)	h (cm)	L	U.Venta
61422	19,60	20,5	19,0	2,6	1

**3 in 1**  
Centrifugadora  
Essoreuse  
Spinner  
Escurreidor  
Passoire  
Colander  
Ensaladera  
Saladier  
Salad bowl



700  
r.p.m.



# Aguja de mechar



## Aguja de Mechar

Aiguille à larder · Spicknadel  
Stuffing needle · Agulha de mechar

Ref	€	Largo (cm)	U.Venta
61362	4,90	19	6



## Jeringas y pipetas para cocina



- Inyecta salsas o especias.
- Extrae la salsa para reducirla en la sartén.

- Injecter des sauces ou des épices.
- Extraire la sauce pour la réduire dans la casserole.
- Inject sauces or spices.
- Extract the sauce to reduce it in the pan.



## Jeringa para cocina

Seringue de cuisine · Spritze Küche  
Kitchen syringe · Seringa para cozinha

Ref	€	Largo (cm)	ml	Unidad	U.Venta
61418	6,20	21,5	30	ml-oz-tsp-Tbsp	6

## Carnes y pescados más jugosos



- Su forma puntiaguda y alargada, permite abrir orificios fácilmente en la carne o pescado e insertar tiras de beicon, verduras, frutas, quesos o especias.
- Sistema de amarre con doble superficie dentada para una perfecta sujeción.
- Consigue carnes más sabrosas y pescados más jugosos.
- Apta para el lavavajillas.

- Sa forme pointue et allongée, vous permet d'ouvrir facilement des trous dans la viande ou le poisson et d'insérer des bandes de beicon, des légumes, des fruits, des fromages ou des épices.
- Système d'amarrage avec double dents pour un support parfait.
- Obtenez des viandes plus savoureuses et plus de poissons juteux.
- Convient au lave-vaisselle.

- Its pointed and elongated shape, allows you to open holes easily in meat or fish and insert beicon strips, vegetables, fruits, cheeses or spices.
- Mooring system with double teeth for a perfect support.
- Get tastier meats and more juicy fish.
- Suitable for dishwasher.



INOX

## Pipeta para salsa

Poire à jus · Sossenspritze  
Sauce syringe · Pipeta para molho

Ref	€	Largo (cm)	ml	U.Venta
A 61408	18,10	30	40	1
B 61416	13,20	30	40	1



# Botellas biberon

PE LDPE  
Polyethylene Polyethylene  
BPA free

- Ideales para salsas, cremas, aceites, aliños, vinagretas y todo tipo de condimentos líquidos.
- Dibuja, adorna y personaliza con estilo tus platos.

- Idéal pour les sauces, les crèmes, les huiles, les assaisonnements, les vinaigrettes et tout type de condiments liquides.
- Il dessine, décore et personnalise les plats.

- Ideal for sauces, creams, oils, dressings, vinaigrettes and all kinds of liquid condiments.
- Draw, decorate and personalize your dishes with style.

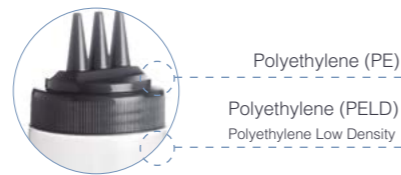
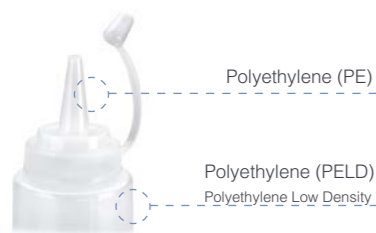

**Botella biberón Tri**  
Bouteille biberon · Dosierflasche  
Squeeze bottle · Garrafa

Ref	€	Ø (cm)	L	U.Venta
61974	4,10	7x20	0,45	6
61977	4,40	7x26	0,70	6



**Ideal para ketchup**  
Ideal for ketchup

**Ideal para mostaza**  
Ideal for mustard

**Botella biberón**  
Bouteille biberon · Dosierflasche  
Squeeze bottle · Garrafa

Ref	€	Ø (cm)	L	U.Venta
61912	1,50	4x10	0,12	12
61925	1,60	5x19	0,25	12
61940	1,80	5,5x21,5	0,40	12
61970	2,00	7x26	0,70	12
61925R	1,60	5x19	0,25	12
61940R	1,80	5,5x21,5	0,40	12
61970R	2,00	7x26	0,70	12
61925A	1,60	5x19	0,25	12
61940A	1,80	5,5x21,5	0,40	12
61970A	2,00	7x26	0,70	12

**Botella biberon Push**  
Bouteille biberon · Dosierflasche  
Squeeze bottle · Garrafa

Ref	€	Ø (cm)	L	U.Venta
61978	4,60	6x20	0,50	1
61979	4,70	7x20	0,60	1
61980	4,90	7x26	0,70	1



SI  
Silicone

**Botella decoración**  
Biberon à decorer · Dekorierflasche  
Decorating pen · Garrafa decoração

Ref	€	Ø (cm)	L	U.Venta
64457	9,80	5,5x16	0,14	1



# Dosificadores

INOX 18/10  
Dishwasher

- Ideal para rellenar o decorar platos con salsas y cremas calientes y frías.
- Sistema de palanca para un caudal ajustable; práctico y preciso.
- Sistema antigoteo y antisalpicaduras.
- Mango con diseño ergonómico que permite el manejo con una sola mano.
- Fácil desmontaje para una sencilla limpieza. Apto para el lavavajillas.

- Idéal pour remplir ou décorer les plats avec des sauces et des crèmes chaudes et froides.
- Système de levier pour un débit réglable; pratique et précis.
- Système anti-tote et antisalpicaduras.
- Mango avec conception ergonomique qui permet de manipuler d'une seule main.
- Démontage facile pour un nettoyage simple. Compatible pour le lave-vaisselle.

- Perfect for filling or decorating dishes with hot or cold sauces and cream.
- Its lever system for controlling the flow is practical and precise.
- Anti-drip and anti-splash system.
- The ergonomic handle means it can be used with just one hand.
- It's easy to disassemble for easy cleaning and it's dishwasher safe.

SI PE  
Silicone Polyethylene  
BPA free

**Dosificador Red**  
Entonnoir à decor · Dosierer  
Portionner · Dosificador

Ref	€	cm	h(cm)	L	U.Venta
67026	12,10	16x11	18	1,0	1



Marcas de medición (ml - cup)  
Measuring marks (ml - cup)

Sistema de gatillo para un caudal ajustable  
Trigger system for an adjustable flow

**Dosificador Inox**  
Entonnoir à decor · Dosierer  
Portionner · Dosificador

Ref	€	Ø (cm)	h(cm)	L	U.Venta
67150	63,30	19	27	2,0	1

3  
Boquillas  
Nozzles



Sistema de gatillo para un caudal ajustable  
Trigger system for an adjustable flow

Incluye soporte y un platillo antigoteo  
Includes support and a drip dish

**Dosificador Ration**  
Entonnoir à decor · Dosierer  
Portionner · Dosificador

Ref	€	L	U.Venta
67000	91,00	2,00	1

3  
Boquillas  
Nozzles



Sistema de gatillo para un caudal ajustable  
Trigger system for an adjustable flow

Incluye soporte  
Includes support

# Sifones



Dishwasher

- **Robusto y duradero.**
- **Marcaje de llenado grabado en el exterior del cuerpo.**
- **Versátil: Diseñado para espumas frías y espumas calientes.**
- **Incluye 3 boquillas con formas decorativas.**
- **Funciona con cargas de gas (N2O).**
- **Cepillo limpiador para facilitar la limpieza.**

- Robuste et durable.
- Marquage de remplissage gravé à l'extérieur du corps.
- Versatile : conçu pour des préparations froides et chaudes.
- Inclut 3 douilles des formes décoratives.
- Fonctionne avec des cartouches de gaz (N2O).
- Brosse pour faciliter le nettoyage.

- Robust and durable.
- Embossed filling marks on the outside.
- Versatile: designed for whipping up hot or cold foams.
- Includes 3 nozzles with decorative shapes.
- Charged with gas cartridges (N2O).
- Cleaning brush for easy cleaning.

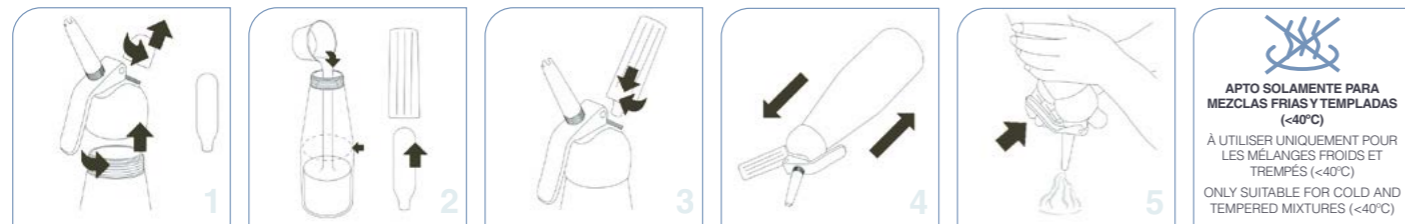

**EXCLUSIVAMENTE PARA USO ALIMENTICIO**  
EXCLUSIVELY FOR FOOD USE



## Cargas para sifón N2O

Charges de siphon N2O · Charges for N2O siphon ·

Ref	€	Botellas	Peso (g)	U.Venta
68402	8,50	10	8	1
68403	19,90	24	8	1

## Sifón Epicure

Siphon à crème · Sahnebereiter  
Cream whipper · Sifão creme

Ref	€	Ø (cm)	L	U.Venta
68300	111,00	9,0	0,50	1
68301	126,00	9,0	1,00	1

**Temperatura de uso** · Use temperature  
min = +5°C / max = +70°C



## Sifón White

Siphon à crème · Sahnebereiter  
Cream whipper · Sifão creme

Ref	€	Ø (cm)	L	U.Venta
68502	41,70	9x27	0,25	1
68500	49,40	9x31	0,50	1
68501	55,10	11x36	1,00	1

**Temperatura de uso** · Use temperature  
min = +5°C / max = +40°C

## Sifón black

Siphon à crème · Sahnebereiter  
Cream whipper · Sifão creme

Ref	€	Ø (cm)	L	U.Venta
68604	52,10	7,8x27,3	0,50	1
68605	57,40	9,3x32,5	1,00	1

**Temperatura de uso** · Use temperature  
min = +5°C / max = +40°C



## Sifón Mix

Siphon à crème · Sahnebereiter  
Cream whipper · Sifão creme

Ref	€	Ø (cm)	L	U.Venta
68404	85,00	7,8x25	0,50	1
68405	97,70	9,3x32,5	1,00	1

**Temperatura de uso** · Use temperature  
min = +5°C / max = +40°C



# Ahumadores

AL

Aluminium Dishwasher



- **Técnica popular de la cocina creativa; otorga a los platos aromas especiales y personalizados.**
- **Perfecto para ahumar todo tipo de alimentos (carnes, pescados, quesos...).**
- **La construcción y su diseño facilitan la limpieza y el mantenimiento.**
- **Ideal para presentar y terminar platos delante del cliente.**
- **Incluye un set de filtros de recambio.**
- **Fácil de transportar gracias a su forma y tamaño.**
- **Pilas no incluidas.**
- **\* Compatible con nuestras campanas de ahumado y la tapa.**

- Technique populaire de la cuisine créative; qui confère aux plats des arômes spéciaux et personnalisés.
- Parfait pour fumer tout type d'aliments (viandes, poissons, fromages...).
- La fabrication et la conception de chacune de ses parties facilite son nettoyage et son entretien.
- Idéal pour présenter et apporter la touche finale à des plats devant le client.
- Inclut un set de filtres de recharge.
- Facile à transporter grâce à sa forme et sa taille.
- Piles non incluses.
- \* Compatible avec nos cloches de fumage et à couvercle.

- A popular creative cooking technique which gives dishes special and personalised aromas.
- Perfect for smoking all kinds of foods (meat, fish, cheeses...).
- The way it is designed and constructed makes it easy to clean and maintain.
- Ideal for presenting and finishing dishes in front of the customer.
- Includes a set of replacement filters.
- Easy to transport thanks to its shape and size.
- Batteries not included.
- \* Compatible with our smoking cloches and the lid.



69221 - 69321  
**Incluyen bolsa de serrín (100 g)**  
Wood Chips bag included (100 g)  
**Olivo · Olive**

- **Permite ahumar dos platos a la vez, ahorrando tiempo.**
- **Incluye 2 mangueras de goma de 40 cm, 2 boquillas y un conector de conexión de mangueras.**

- Il permet de fumer deux plats à la fois, économisant ainsi du temps.
- Il comprend deux tuyaux en caoutchouc de 40 cm, deux embouts et un raccord de tuyaux.

- Two dishes can be smoked at once to save time.
- Two 40 cm rubber hoses, two nozzles and a hose connector included.



## Ahumador de alimentos

Fumoir pour aliments · Apparat zum Räuchern von Lebensmitteln  
Food smoker · Defumador de alimentos

Ref	€	U.Venta
A 69221	44,90	1
B 69321	60,20	1



**Mangueras de goma flexible**  
Flexible rubber hoses



## Manguera doble para ahumador

Double tuyau pour fumoir · Doppelschlauch für Räucherapparat  
Double hoses for smoker · Manguera dupla para defumador

Ref	€	Largo (cm)	U.Venta
69521	8,20	40	1

# Campanas para ahumar

VIDRIO Glass  
SI Silicone  
Dishwasher

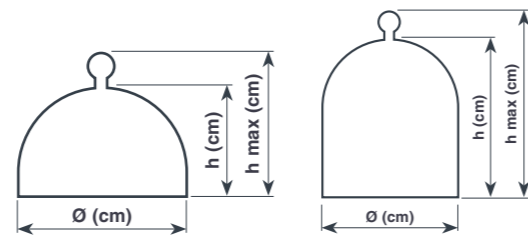

- Fabricada en cristal borosilicato de gran calidad. Es resistente a golpes, altas y bajas temperaturas.
- Permite la entrada de humo, vapor y aromas para ahumar o aromatizar alimentos sin tener que levantar la tapa.
- Cuenta con una válvula de inyección con autocierre de silicona (max. 200°C).
- Apta para microondas, horno y congelador.
- Complemento ideal para los ahumadores de alimentos Lacor.

- Fabriqué en cristal borosilicé de haute qualité. Il est résistant aux coups, à des températures élevées et basse.
- Il permet à l'entrée de la fumée, de la vapeur et des arômes de fumer ou d'aromatiser les aliments sans avoir à soulever le couvercle.
- Il a une soupape d'injection avec un auto-économe en silicone (max. 200 °C).
- Convient au micro-ondes, au four et au congélateur.
- Complément idéal aux Ahumadores de la nourriture Lacor.

- Manufactured in high quality borosilicate crystal. It is resistant to blows, high and low temperatures.
- It allows the entry of smoke, steam and aromas to smoking or aromatizing food without having to lift the lid.
- It has an injection valve with Silicone Selfocierre (Max. 200°C).
- Suitable for microwave, oven and freezer.
- Ideal complement to Lacor food ahumadores.



- Tapa en forma de CD para crear un efecto hermético al momento de ahumar.
- Válido para todo tipo de envases, vasos, cocteleras, tarros, etc.
- Ideal para ahumar cócteles, destilados, comidas, quesos, etc.
- Válvula de inyección con autocierre de silicona (200°C).

- Couverture en forme de CD pour créer un effet hermétique lors du tabagisme.
- Valable pour tous les types de conteneurs, navires, cocktails, pots, etc.
- Idéal pour fumer des cocktails, des distillats, des repas, des fromages, etc.
- Vanne d'injection avec Silicone Autocierre (200 °C).

- CD-shaped cover to create a hermetic effect when smoking.
- Valid for all types of containers, vessels, cocktails, jars, etc.
- Ideal for smoking cocktails, distillates, meals, cheeses, etc.
- Injection valve with Silicone Autocierre (200°C).

## Campana ahumador

Cloche à fumer · Räucherlocke  
Smoker Hood · Campânula defumadora

Ref	€	Ø (cm)	h(cm)	h max (cm)	U.Venta	
A	61813	13,00	12,5	7,5	11,0	1
B	61815	21,30	16,0	12,0	15,0	1
C	61816	23,60	20,0	12,0	15,0	1
D	61817	40,30	25,0	14,0	17,0	1
E	61811	27,30	18,5	22,0	25,0	1
F	61812	32,50	12,5	26,5	30,0	1

Para cocteles  
For cocktails

ASA Acrylic  
SI Silicone

## Tapa para ahumar

Chapeau de fumée · Rauchdeckel  
Smoke cap · Tampa de fumaça

Ref	€	Ø (cm)	U.Venta
69554	4,00	12	1

# Serrín para ahumar



100 g



600 g

## Natural 100% Quality

La mejor elección para ahumar todo tipo de alimentos  
The best choice to smoke all kinds of food

- Serrín especial de madera (99'9 % de pureza).
- Produce un humo denso y de alta calidad.
- Aporta un sabor muy suave aromatizado a los alimentos, gracias a una combustión lenta a baja temperatura.
- Cumple todas las normas y reglamentaciones existentes para el empleo con los alimentos.
- Compatible con el ahumador de alimentos de Lacor (ref. 69221 y ref: 69321).
- OLIVO: aporta a los alimentos un sabor suave y aromático.
- NARANJO: aporta a los alimentos un sabor dulce, afrutado y el frescor de los cítricos.
- LIMONERO: aporta a los alimentos un toque cítrico y dulce muy suave.
- ALMENDRO: aporta a los alimentos un aroma suave, dulce y floral de la almendra.
- WHISKY: aporta a los alimentos un aroma de barril de roble empleado para el reposo del Whisky
- COGNAC: aporta a los alimentos un aroma de barril de roble empleado para el reposo del Cognac.

- Special Wood Serrin (Pureté de 99'9%).
- Il produit une fumée dense et de haute qualité.
- Il offre une saveur très douce aromatisée aux aliments, grâce à une combustion lente à basse température.
- Il répond à toutes les normes et réglementations existantes pour la nourriture avec de la nourriture.
- Compatible avec la nourriture de Lacor Ahumador (réf. 69221 et réf: 69321).
- OLIVE: apporte aux aliments un goût doux, fruité et la fraîcheur des agrumes.
- ORANGE: apporte aux aliments un arôme délicat, doux et floral d'amande.
- CITRONNIER: apporte aux aliments une touche d'agrumes douce et très délicate.
- AMANDIER: apporte aux aliments un arôme délicat, doux et floral d'amande.
- WHISKY: apporte aux aliments un arôme de fut de chêne utilisée pour le vieillissement du whisky.
- COGNAC: apporte aux aliments un arôme de fut de chêne utilisée pour le vieillissement du cognac.

- Special Wood Serrin (99'9 % purity).
- It produces a dense and high quality smoke.
- It provides a very soft flavor aromatized to food, thanks to slow combustion at low temperature.
- It meets all existing standards and regulations for food with food.
- Compatible with Lacor's food ahumador (Ref. 69221 and REF: 69321).
- OLIVE: provides food a smooth and aromatic flavour.
- ORANGE: provides food a sweet, fruity taste and citrusy freshness.
- LEMON: provides food a very soft sweet citrusy touch.
- ALMOND: provides food with a soft, sweet, floral aroma of almonds.
- WHISKY: aromatic sawdust from the oak barrel used for ageing the whiskey.
- COGNAC: aromatic sawdust from the oak barrel used for ageing the cognac.

## Serrín para ahumar

Scire de bois · Räuchermehl  
Wood chips · Serrín de madeira

Ref	€	g	U.Venta	
69550	6,80	100	1	Olivo · Olive
69551	6,80	100	1	Naranja · Orange
69552	6,80	100	1	Limonero · Lemon
69553	6,80	100	1	Almendro · Almond
69559	6,80	100	1	Whisky
69560	6,80	100	1	Cognac
69555	9,20	600	1	Olivo · Olive
69556	9,20	600	1	Naranja · Orange
69557	9,20	600	1	Limonero · Lemon
69558	9,20	600	1	Almendro · Almond
69567	8,70	500	1	Whisky
69568	8,70	500	1	Cognac

# Jarras medidoras

INOX  
18/10  
Dishwasher



**Jarra medidora Inox**  
Pot mesureur · Mass Behälter  
Measuring jug · Jarra de medidas

Ref	€	Ø (cm)	L	U.Venta
62750	77,90	17x22,5	5,00	1

VIDRIO  
Glass  
Microwave



**Jarra medidora Cristal**  
Pot mesureur · Mass Behälter  
Measuring jug · Jarra de medidas

Ref	€	L	U.Venta
67133	11,30	0,5	1

PMMA  
Plastic  
BPA free



**Vaso medidor Basic**  
Verre doseur · Messbecher  
Measuring cup · Copo medidor

Ref	€	Ø (cm)	h(cm)	L	U.Venta
67075	7,60	8,5	16,0	0,5	1
67071	9,90	10,5	19,0	1,0	1

PP  
Polypropylene  
BPA free



**Jarras medidoras Pro**  
Pot mesureur · Mass Behälter  
Measuring jugs · Jarras de medidas

Ref	€	Ø (cm)	h(cm)	L	U.Venta
67210	3,60	9,0	13,8	0,5	1
67211	4,70	12,0	17,0	1,0	1
67212	8,10	15,0	20,8	2,0	1
67213	10,60	17,0	23,5	3,0	1
67214	16,40	20,0	27,5	5,0	1

**Jarra medidora**  
Couvercle · Deckel  
Lid · Tampa



Ref	€	Ø (cm)	h(cm)	L	U.Venta
62742	26,50	15,0	17,0	2,0	1
62741	22,40	11,5	13,0	1,0	1

SAN  
Plastic  
BPA free



**Set 3 jarras medidoras Tri**  
Ensemble de 3 pot mesureur · 3-tlg. Satz Messbecher  
3 piece measuring jugs · Jogo 3 jarras de medidas

Ref	€	L	U.Venta
67131	15,60	0,25	1
		0,5	
		1,0	

PP  
Polypropylene  
BPA free



**Set 3 jarras medidoras**  
Set 3 pichets doseurs · Messbecher, 3 Er-Setr  
Set of 3 measuring jugs · Conjunto 3 jarras medidas

Ref	€	Ø (cm)	h(cm)	L	U.Venta
67130	9,40	9,5	8,5	0,25	1
		11,0	10,0	0,50	
		13,0	11,5	1,00	

PP  
Polypropylene  
BPA free



**Set 5 jarras medidoras Pro**  
Setn 5 pichets doseurs · Messbecher, 5 Er-Setr  
Set of 5 measuring jugs · Conjunto 5 jarras medidas

Ref	€	cm	h(cm)	L	U.Venta
67215	41,00	15x9	15,3	0,5	1
		18x11	18,8	1,0	
		22x15	23,0	2,0	
		24x17	26,0	3,0	
		27x20	30,2	5,0	

Medir y pesar  
Measure and weigh



# Set medición Exact

# Set 4 boles Practic

# Set 6 boles Multi

# Boles Inox



- Todas las piezas fabricadas en materiales de máxima calidad, libres de BPA.
- Versátil. Ideal para ingredientes líquidos y secos.
- Jarra con sistema de lectura rápida en litros y cups. Permite comprobar el nivel del líquido mientras se está vertiendo el contenido.
- Cazos marcados en ml y bps para una rápida identificación.

- Tous les pièces en matériaux de qualité maximale, sans BPA.
- Polyvalent. Idéal pour les ingrédients liquides et secs.
- Jug avec système de lecture rapide en litres et tasses. Il permet de vérifier le niveau du liquide pendant que le contenu coule.
- Économise marquée en ML et BPS pour une identification rapide.

- All pieces made of maximum quality materials, BPA free.
- Versatile. Ideal for liquid and dry ingredients.
- Jug with fast reading system in liters and cups. It allows to check the level of the liquid while the content is pouring.
- Saves marked in ML and BPS for rapid identification.

Raspador · Scraper

6 cazos medidores  
6 measuring cups  
(7,5 ml, 15 ml, 60 ml,  
85 ml, 125 ml, 250 ml)

Embudo · Funnel

Jarra medidora  
Measuring jug  
(1,0 L / 4 cups)

Compacto · Compact



- Práctico y versátil.
- Fabricados en polipropileno de máxima calidad. 100% Libre de BPA.
- Jarras medidoras graduadas (mililitros/cups).
- Pequeño vertedor lateral para facilitar el vertido.
- Asas ergonómicas para facilitar el transporte.
- 100% estable gracias a los pies antideslizantes.
- Apilables; ocupan el mínimo espacio posible.
- Aptos para el lavavajillas.

- Pratique et polyvalent.
- Fabriqué en polypropylène de qualité maximale. 100% BPA gratuit.
- PUILLES de compteur gradué (millilitres / tasses).
- Petit décharge latérale pour faciliter la décharge.
- Poignées ergonomiques pour faciliter le transport.
- 100% stable grâce aux pieds non glissants.
- Empilable; Ils occupent l'espace minimum possible.
- Apte pour le lave-vaisselle.

- Practical and versatile.
- Manufactured in maximum quality polypropylene. 100% BPA free.
- Graduated meter jugs (milliliters/cups).
- Small lateral dump to facilitate discharge.
- Ergonomic handles to facilitate transportation.
- 100% stable thanks to non-slip feet.
- Stackable; They occupy the minimum possible space.
- Apt for the dishwasher.

Jarra medidora  
Measuring jug (0,5 L)

Jarra medidora  
Measuring jug (1,0 L)

Apilables · Stackable

Escurridor  
Colander (2,0 L)

Bol mezclador  
Mixing bowl (3,5 L)

## Set de 4 boles Practic

Ensemble de 4 récipients · Schüsseln, 4er-Set  
Set of 4 bowls · Conjunto de 4 tigelas

Ref	€	Ø (cm)	h(cm)	L	U.Venta
62633	36,10	11,5	9,3	0,5	1
		14,5	10,6	1,0	
		18,5	13,0	2,0	
		22,0	15,0	3,5	

## Set de medición Exact

Set de mesure · Messbecher-Set  
Measuring set · Conjunto de medição

Ref	€	cm	h(cm)	U.Venta
62740	16,40	20x11	13,6	1

- Set de 6 boles de polipropileno de máxima calidad, 100% libres de BPA.
- Versátiles: ideales para mezclar, batir, preparar masas, servir ensaladas o salsas.
- Compuesto por 6 boles perfectamente apilables entre sí.
- Incluye 6 tapas fabricadas en polipropileno, libres de BPA.
- Perfectos para almacenar y conservar los alimentos.
- Fácil limpieza. Cuerpos aptos para el lavavajillas.

- Ensemble de 6 bols en polypropylène de qualité maximale, 100% exempts de BPA.
- Polyvyle: idéal pour mélanger, battre, préparer des masses, servir des salades ou des sauces.
- Composé de 6 boudons parfaitement empilables les uns aux autres.
- Comprend 6 couvertures fabriquées en polypropylène, sans BPA.
- Parfait pour stocker et conserver la nourriture.
- Nettoyage facile. Corps adaptés au lave-vaisselle.

- Set of 6 polypropylene bowls of maximum quality, 100% free of BPA.
- Versatile: Ideal to mix, beat, prepare masses, serve salads or sauces.
- Composed of 6 bolts perfectly stackable to each other.
- Includes 6 covers manufactured in polypropylene, BPA free.
- Perfect to store and conserve food.
- Easy cleaning. Dishwasher safe bodies.

Cuerpos aptos para el lavavajillas  
Dishwasher safe bodies

## Set 6 boles Multi

Ensemble de 6 récipients · Schüsseln, 6er-Set  
Set of 6 bowls · Conjunto de 6 tigelas

Ref	€	Ø (cm)	h(cm)	L	U.Venta
60055	20,50	10,0	5,0	0,25	1
		14,0	6,8	0,80	
		17,0	8,0	1,15	
		20,3	9,5	2,00	
		24,3	11,0	3,35	
		28,3	12,5	5,25	

## Set 3 boles Inox

Ensemble de 3 récipients · Schüsseln, 3er-Set  
Set of 3 bowls · Conjunto de 3 tigelas

Ref	€	Ø (cm)	h(cm)	L	U.Venta
60050	33,30	16	10,0	1,5	1
		18	11,0	2,2	
		20	12,5	3,0	
60051	44,90	20	12,5	3,0	1
		22	13,5	3,8	
		24	14,0	4,0	

garinox®

## Bol Cónico Garinox

Bol conique · Schüssel, konisch  
Conical mixing bowl · Bacia cônica

Ref	€	Ø (cm)	h(cm)	L	U.Venta
14016	3,90	16	6,5	0,90	12
14019	5,30	20	7,5	1,40	12
14025	9,70	24	9,0	2,50	1
14029	13,20	30	11,0	4,30	1
14033	18,30	34	13,5	7,50	1
14040	23,30	40	15,5	11,50	1
14046	33,10	45	17,5	17,40	1
14049	38,80	50	19,0	22,60	1

# Calderos

INOX 18/10  
Dishwasher



## Caldero semiesférico sin asas

Bassine hemispherique s/anses · Schneeschlagkessel ohne Griffe  
Semi-spherical mixing bowl w/out/handles · Bacia semi-esférica sem asas

## Caldero semiesférico con asas

Bassine hemispherique a/anses · Schneeschlagkessel mit Griffe  
Semi-spherical mixing bowl w/handles · Bacia semi-esférica com asas

Ref	€	Ø (cm)	h(cm)	L	U.Venta
50323S	37,50	22	11,0	2,70	1
50327S	43,80	26	13,0	4,00	1
50333S	58,80	32	17,0	9,50	1
50337S	66,70	36	18,0	12,00	1
50341S	111,90	40	21,0	14,50	1
50300	26,40	-	-	-	1

Ref	€	Ø (cm)	h(cm)	L	U.Venta
50323	49,40	22	11,0	2,70	1
50327	56,20	26	13,0	4,00	1
50333	72,20	32	17,0	9,50	1
50337	77,70	36	18,0	12,00	1
50341	111,10	40	21,0	14,50	1
50300	26,40	-	-	-	1



## Caldero cónico

Bassine conique · Wanne  
Mixing bowl · Bacia cónica

## Caldero cónico con asas

Bassine conique à anses · Wanne mit Griffe  
Conical mixing bowl · Bacia cónica con asas

Ref	€	Ø (cm)	h(cm)	L	U.Venta
60013	12,70	13	6,1	0,55	1
60016	13,80	16	9,1	1,00	1
60020	18,90	20	11,7	2,12	1
60024	22,70	24	12,6	3,50	1
60028	28,40	28	13,4	5,25	1
60032	31,90	32	15,0	7,65	1
60036	44,10	36	16,0	11,00	1
60040	51,20	40	18,0	15,00	1

Ref	€	Ø (cm)	h(cm)	L	U.Venta
50828	44,30	28	13,2	5,00	1
50832	49,10	32	14,5	7,00	1
50836	56,20	36	16,0	11,00	1
50840	62,50	40	18,0	15,00	1
50845	74,60	45	20,0	22,00	1
50850	89,50	50	21,0	30,00	1

garinox®



## Cubo Garinox

Seau · Eimer  
Pail · Balde

Ref	€	Ø (cm)	h(cm)	L	U.Venta
14114	9,60	16-12	15,5	1,40	1
14119	18,10	20-15	20,0	4,60	1
14124	22,50	24-17,2	20,5	5,60	1
14128	40,90	28-21	25,8	14,00	1

## Cazo servir Pochon

Pochon · Suppenkelle "Pochon" (Für server)  
Pochon soup ladle for server · Caçarole servir "Pochon"

Ref	€	Ø (cm)	Largo (cm)	L	U.Venta
60520	61,30	20	42,5	2,00	1



# Etern

INOX 18/10

CRISTAL Glass

Oven

Microwave

Freezer

Dishwasher

BPA free

- Recipiente de acero inoxidable 18/10 apto para el microondas.
- Tapa de cristal con válvula para dejar circular el aire.
- ClipLock System: Los 4 cierres de clip sujetan firmemente la tapa asegurando su estanqueidad.
- 100% hermético: Gracias a la junta de silicona extraíble que incorpora la tapa.
- Ligeros y resistentes: ideales para guardar alimentos y transportar la comida a cualquier lugar.
- Higiénicos y antibacterianos: No transmiten olores ni sabores a los alimentos.
- Recipientes apto para el microondas, el horno (sin tapa), el lavavajillas, el frigorífico y el congelador.
- Apilables: ahorra espacio en la cocina.
- Ecológicos, reutilizables y libre de BPA.

- Récipient en acier inoxydable 18/10 apte pour le micro-ondes.
- Couvercle en verre avec valve pour laisser circuler l'air.
- ClipLock System : Les 4 clips de fermeture tiennent fermement le couvercle, garantissant ainsi son étanchéité.
- 100% hermétique : Grâce au joint en silicone extractible que possède le couvercle.
- Léger et résistant : Idéal pour ranger les aliments et transporter la nourriture partout.
- Hygiénique et antibactérien : Ne transmet ni odeurs ni goûts aux aliments.
- Récipient apte pour le micro-ondes, le four (sans couvercle), le lave-vaisselle, le réfrigérateur et le congélateur.
- Empilable : gain de place dans la cuisine.
- Écologique, réutilisable et sans BPA.

- 18/10 stainless steel container suitable for the microwave.
- Glass lid with valve for air circulation.
- ClipLock System: the 4 clip locks hold the lid securely in place, ensuring water tightness.
- 100% leak-proof due to the removable silicone gasket in the lid.
- Lightweight and robust: perfect for storing food and taking it wherever you want to go.
- Hygienic and antibacterial: does not transmit odours or flavours.
- Microwave, oven (without lid), dishwasher, fridge and freezer safe container and lid.
- Stackable: space saving in the kitchen.
- Eco-friendly, reusable and BPA-free.



## Recipiente rectangular

Récipient rectangulaire · Rechteckbehälter  
Rectangular container · Recipiente rectangular

Ref	€	ml	cm	h(cm)	U.Venta
64608	11,00	480	15,5x11,5	5,8	1
64600	11,40	800	18x13,5	7,0	1
64601	13,00	1250	20,5x15,5	7,5	1
64602	16,10	1800	23x17,5	8,0	1
64609	11,70	820	20x15	5,0	1

## Recipiente cuadrado

Récipient carré · Quadratischer Behälter  
Square container · Recipiente quadrado

Ref	€	ml	cm	h(cm)	U.Venta
64603	10,10	650	14x14	7	1
64604	14,20	1500	18,5x18,5	8	1

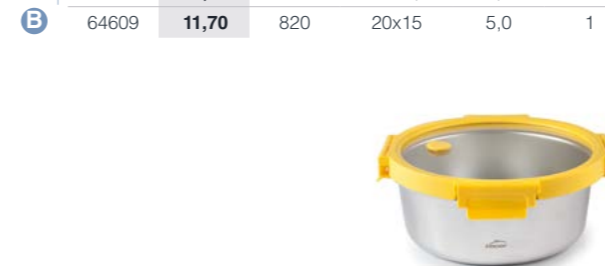

## Recipiente redondo

Récipient rond · Runder Behälter  
Round container · Recipiente redondo

Ref	€	ml	cm	h(cm)	U.Venta
64605	10,30	700	16x16	6,5	1
64606	14,70	1500	20x20	7,5	1

## Set 3 recipientes

Set de 3 récipients · Set mit 3 Behältern  
Set with 3 containers · Conjunto com 3 recipientes

Ref	€	ml	cm	h(cm)	U.Venta
64607	39,80	800	18x13,5	7	1
		1200	20,5x15,5	7,5	
		1800	23x17,5	8	



# Ecoinox

**INOX 18/10** **PP** **BPA free**

- Recipiente de acero inoxidable 18/10 apto para el microondas.
- Tapa de polipropileno.
- **ClipLock System: Los 4 cierres de clip sujetan firmemente la tapa asegurando su estanqueidad.**
- **100% hermético: Gracias a la junta de silicona extraíble que incorpora la tapa.**
- **Ligeros y resistentes: ideales para guardar alimentos y transportar la comida a cualquier lugar.**
- **Higiénicos y antibacterianos: No transmiten olores ni sabores a los alimentos.**
- **Recipientes apto para el microondas y el horno. Recipientes y tapas aptos para el lavavajillas, el frigorífico y el congelador.**
- **Apilables: ahorra espacio en la cocina.**
- **Ecológicos, reutilizables y libre de BPA.**

- Récipient en acier inoxydable 18/10 apte pour le micro-ondes.
- Couvercle en polypropylène.
- ClipLock System : Les 4 clips de fermeture tiennent fermement le couvercle, garantissant ainsi son étanchéité.
- 100% hermétique : Grâce au joint en silicone extractible que possède le couvercle.
- Léger et résistant : Idéal pour ranger les aliments et transporter la nourriture partout.
- Hygiénique et antibactérien : Ne transmet ni odeurs ni goûts aux aliments.
- Récipient apte pour le micro-ondes et le four. Récipient et couvercle aptes pour le lave-vaisselle, le réfrigérateur et le congélateur.
- Empilable : gain de place dans la cuisine.
- Écologique, réutilisable et sans BPA.

- 18/10 stainless steel container suitable for the microwave.
- Polypropylene lid.
- ClipLock System: the 4 clip locks hold the lid securely in place, ensuring water tightness.
- 100% leak-proof due to the removable silicone gasket in the lid.
- Lightweight and robust: perfect for storing food and taking it wherever you want to go.
- Hygienic and antibacterial: does not transmit odours or flavours.
- Microwave and dishwasher safe.
- Dishwasher, fridge and freezer safe container and lid.
- Stackable: space saving in the kitchen.
- Eco-friendly, reusable and BPA-free.



## Recipiente rectangular

Récipient rectangulaire · Rechteckbehälter  
Rectangular container · Recipiente rectangular

Ref	€	ml	cm	h(cm)	U.Venta
64622	6,60	260	12,7x9	5,1	1
64618	8,20	480	15,5x11,5	5,8	1
64610	8,80	800	18x13,5	7,0	1
64611	10,90	1250	20,5x15,5	7,5	1
64612	13,60	1800	23x17,5	8,0	1
64619	9,20	820	20x15	5,0	1

## Recipiente cuadrado

Récipient carré · Quadratischer Behälter  
Square container · Recipiente quadrado

Ref	€	ml	cm	h(cm)	U.Venta
64613	8,20	650	14x14	7	1
64614	11,70	1500	18,5x18,5	8	1

## Recipiente redondo

Récipient rond · Runder Behälter  
Round container · Recipiente redondo

Ref	€	ml	cm	h(cm)	U.Venta
64615	8,40	700	16x16	6,5	1
64616	12,60	1500	20x20	7,5	1

## Set 3 recipientes

Set de 3 recipientes · Set mit 3 Behältern  
Set with 3 containers · Conjunto com 3 recipientes

Ref	€	ml	cm	h(cm)	U.Venta
64623	19,40	260 (x3)	12,7x9	5,1	1
64617	32,20	800	18x13,5	7	1
		1200	20,5x15,5	7,5	
		1800	23x17,5	8	



# Recipiente TwoGo

new

**INOX 18/10** **AS** **BPA free**

- **Recipiente de acero inoxidable 18/10 con dos compartimentos apto para el microondas. Tapa de plástico AS.**
- **ClipLock System: los 4 cierres de clip sujetan firmemente la tapa asegurando su estanqueidad.**
- **100% hermético: gracias a la junta de silicona extraíble que incorpora la tapa.**
- **Ligero y resistente: ideal para guardar alimentos y transportar la comida a cualquier lugar.**
- **Higiénico y antibacteriano: no transmite olores ni sabores a los alimentos.**
- **Recipiente apto para el microondas y el horno. Recipiente y tapa aptos para el lavavajillas, el frigorífico y el congelador.**
- **Ecológico, reutilizable y libre de BPA.**

- Récipient en acier inoxydable 18/10 avec deux compartiments allant au micro-ondes. Couvercle en plastique AS.
- ClipLock System : les 4 clips de fermeture tiennent fermement le couvercle, garantissant ainsi son étanchéité.
- 100% hermétique : grâce au joint en silicone extractible que possède le couvercle.
- Léger et résistant : idéal pour ranger les aliments et transporter la nourriture partout.
- Hygiénique et antibactérien : ne transmet ni odeurs ni goûts aux aliments.
- Récipient apte pour le micro-ondes et le four. Récipient et couvercle aptes pour le lave-vaisselle, le réfrigérateur et le congélateur.
- Écologique, réutilisable et sans BPA.

- 18/10 stainless steel container with two microwave-safe compartments. AS plastic lid.
- ClipLock System: the 4 clip locks hold the lid securely in place, ensuring water tightness.
- 100% leak-proof due to the removable silicone gasket in the lid.
- Lightweight and robust: perfect for storing food and taking it wherever you want to go.
- Hygienic and antibacterial: does not transmit odours or flavours.
- Microwave and dishwasher safe.
- Dishwasher, fridge and freezer safe container and lid.
- Eco-friendly, reusable and BPA-free.



## Recipiente TwoGo

Récipient · Behälter  
Container · Recipiente

Ref	€	cm	h (cm)	ml	U.Venta
64620	12,80	21,7x16,6	5,5	450-280	1

# Básculas profesionales



**Cabezal orientable y abatible**  
Retractable, swivelling head

**Cuerpo aluminio fundido**  
Cast aluminium case

**Plataforma inoxidable 53x44cm**  
St. Steel platform, 53x44 cm

**Plataforma inoxidable 30x24 cm**  
**Plataforma extraíble**  
**Doble display (Delante / Detrás)**  
**Teclado intuitivo y de fácil uso**  
**Patas de apoyo regulables**

St. Steel platform, 30x24 cm  
Removable platform  
Double display (Front / Back)  
Intelligent and easy-to-use keyboard  
Adjustable support feet



## Báscula profesional electrónica

Balance électronique professionnelle · Elektronische Profi-Waagen  
Electronic professional scale · Balança eletrônica profissional

Ref	€	W	Tara	IP	Peso (Kg)	U.Venta
61716	485,10	0,2 W	15kg/5g	IPX 54	4,60kg	1
61730	522,00	0,2 W	30kg/10g	IPX 54	4,60 kg	1

CERTIF.: OIML R76 Clase III, 60/384/ECC

- **Báscula portátil con indicador luminoso externo.**
- **Plataforma fabricada en acero inoxidable de gran resistencia (medidas: 30x25,5cm)**
- **Capacidad máxima de pesada de 180 kg y 0,01 kg de resolución.**
- **Dos modos de alimentación, por red 220V con cargador de corriente incluido o 2 pilas AAA.**
- **Función cero y función tara. Tres unidades de peso: kg, libras, onzas.**
- **Display luminoso externo. Proporciona lecturas instantáneas y precisas.**
- **Apagado automático cuando funciona con pilas.**
- **Máxima estabilidad: pies de goma antideslizantes.**

- Balance portable avec indicateur lumineux externe.
- Plateforme fabriquée en acier inoxydable de grande résistance (dimensions : 30x25,5cm)
- Capacité maximum de pesée de 180 kg et 0,01 kg de résolution.
- Deux modes d'alimentation : sur secteur 220V avec chargeur inclus ou avec piles (2 piles AAA non fournies)
- Fonction zéro et fonction tare. Trois unités de poids : kg, livres, onces.
- Affichage lumineux externe. Fournit des lectures instantanées et précises.
- Arrêt automatique en cas de fonctionnement sur piles.
- Stabilité maximale : pieds en caoutchouc antidérapants.

- Portable scale with external indicator light.
- Platform made of highly resistant stainless steel (measures: 30x25,5cm).
- Maximum weighing capacity of 180 kg and 0.01 kg resolution.
- Two power supply modes, 220V mains with power charger included or 2 AAA batteries.
- Zero function and tare function. Three weight units: kg, pounds, ounces.
- External illuminated display. Provides instant and accurate readings.
- Automatic shut-off when battery operated.
- Maximum stability: non-slip rubber feet.

## Báscula plataforma

Balance à plateforme · Plattformwaage  
Platform scales · Balança de plataforma

Ref	€	cm	Peso (Kg)	División (g)	Unidad	U.Venta
61724	69,90	30x25,5	180	0,01	kg/lb/lb.oz	1

No válidas para uso comercial · Utilisation interdite pour toutes transactions commerciales · Not for trade

# Básculas de cocina electrónicas



- **Básculas perfectas para cualquier cocina.**
- **Función tara.**
- **Reseteo automático a cero.**
- **Pantalla LCD, fácil lectura de los resultados.**
- **Función de apagado automático, ahorrar energía.**
- **Indicador de batería baja y sobrecarga.**

- Balances parfaites pour toutes les cuisines.
- Fonction tare.
- Mise à zéro automatique.
- Écran LCD, lecture facile des résultats.
- Fonction d'arrêt automatique pour permettre des économies d'énergie.
- Indicateur de batterie faible et de surcharge.

- This scales is perfect for any kitchen.
- Tare function.
- Automatic reset to zero.
- LCD screen with easy to read results.
- Automatic shut-off to save energy.
- It has a low battery and overload indicator.

**4 sensores de alta precisión**  
Four high precision sensors



**Plataforma de bambú**  
Bamboo platform



## Báscula de cocina Eben

Balance de cuisine · Küchenwaage  
Kitchen scale · Balança de cozinha

Ref	€	cm	División (g)	Unidad	Peso (Kg)	U. Venta
61717	56,20	31x25,6x2,5	1	g/Kg/oz/lb.oz	15	1

## Báscula de cocina Bamboo

Balance de cuisine · Küchenwaage  
Kitchen scale · Balança de cozinha

Ref	€	cm	División (g)	Unidad	Peso (Kg)	U.Venta
61712	24,40	21,8x18,8x2,1	1	g/ml/lb/oz/fl-oz	5	1

**Plataforma de cristal**  
Glass platform



## Báscula de cocina Slim

Balance de cuisine · Küchenwaage  
Kitchen scale · Balança de cozinha

Ref	€	cm	División (g)	Unidad	Peso (Kg)	U.Venta
61708	28,10	27x18x4	1	g/oz/ml/cups	5	1

## Báscula de cocina Round

Balance de cuisine · Küchenwaage  
Kitchen scale · Balança de cozinha

Ref	€	cm	División (g)	Peso (Kg)	U.Venta
61703	61,80	15,5x12	1	5	1



**Plataforma de cristal**  
Glass platform



INOX

## Báscula de cocina Cristal

Balance de cuisine · Küchenwaage  
Kitchen scale · Balança de cozinha

Ref	€	Peso (Kg)	División (g)	U.Venta
61725	23,20	5	1	1

## Báscula de cocina con bol extraíble

Balance numérique avec bol amovible · Digitalwaage mit abnehmbarer Schale  
Scale digital with removable bowl · Balança digital con bacia removível

Ref	€	Ø (cm)	L	Peso (Kg)	División (g)	U.Venta
61707	37,90	21 (bol)	1,50	5	1	1

new



INOX

### Báscula digital ultraprecisión Doble

Balance digitale ultra-précision double · Sehr präzise küchenwaage dual digital  
High precision dual platform digital scales · Balança digital dupla de ultraprecisão

Ref	€	cm	Peso (Kg)	División (g)	Unidades	U. Venta
61726	49,50	24x20	15	1	g (kg) /oz / ml (agua-ml)	1

- Báscula de alto rendimiento con un diseño de doble plataforma fabricada en acero inoxidable.
- Dos superficies de pesaje ultra precisos, una pesa hasta 15 kg (1 g) y la otra hasta 1 kg (0,05 g).
- Equipado con un sistema de sensores de galgas extensométricas de alta precisión.
- Pantalla retroiluminada que facilita la lectura de los números.
- Encendido/apagado manual. Apagado automático. Reinicio automático.
- Función Tara. Función de bloqueo de peso para la báscula principal.
- Unidades: g (kg) /oz / ml (agua-ml).
- Indicación de baja potencia / sobrecarga.
- Alimentación: 3 pilas AAA de 1,5 V (incluidas).
- Tamaño compacto: fácil de almacenar y utilizar en cualquier lugar.
- Medidas de la báscula: 24x20 cm / Plataforma grande: 22x16 cm / Plataforma pequeña: 19,5x13,5 cm.

- High performance stainless steel dual platform scales.
- Two ultra-precise weighing surfaces: one for weighing up to 15 kg (1 g) and the other for up to 1 kg (0.05 g).
- Equipped with a high precision strain gauge sensor system.
- Backlit display for easy reading of numbers.
- Manual on/off switch. Auto power-off function. Auto restart function.
- Tare mode. Weight lock function for the main scales.
- Units: g (Kg) / oz / ml (water ml).
- Low power / overload indication.
- Power supply: 3 x 1.5 V AAA batteries (included).
- Compact size: easy storage and use anywhere.
- Size of the scales: 24x20 cm / Large platform: 22x16 cm / Small platform: 19,5x13,5 cm.



- Báscula digital de alta precisión con bol extraíble de acero inoxidable.
- Diseño elegante y compacto. Capacidad de 1,8 L.
- Pantalla LCD grande y legible con función TARA.
- Indicador de batería baja y sobrecarga.
- Apagado automático, ahorro de energía.
- Unidad de peso: g / lb:oz / water-ml / milk-ml / fl.oz
- Peso máximo: 5kg / División: 1 g
- Fuente de alimentación (incluida): 2 pilas de 1,5 V AAA.
- Su tamaño compacto facilita su almacenamiento.

- Balance numérique de haute précision avec bol extractible en acier inoxydable.
- Design élégant et compact. Capacité de 1,8 L.
- Écran LCD grand et lisible avec fonction TARE.
- Indicateur de batterie faible et de surcharge.
- Arrêt automatique, économies d'énergie.
- Unité de poids : g / lb:oz / water-ml / milk-ml / fl.oz
- Poids maximum : 5 kg / Division : 1 g
- Source d'alimentation (incluse) : 2 piles de 1,5 V AAA.
- Sa taille compacte facilite son rangement.

- High precision digital scales with removable stainless steel bowl.
- Compact, stylish design. Capacity: 1.8 L.
- Large, easily readable LCD screen with TARE function.
- Low power and overload indication.
- Power-saving AUTO-OFF function.
- Weight units: g / lb:oz / water-ml / milk-ml / fl.oz
- Max weight: 5 kg / Division: 1 g.
- Power source: 2 x 1.5 V AAA batteries (included).
- Compact size for easy storage.



INOX

### Báscula con bol Just

Balance avec bol · Waage mit Schüssel  
Scales with bowl · Balança com taça

Ref	€	Peso (Kg)	División (g)	L	Unidades	U. Venta
61727	26,60	5 max	1	1,8	g/lb/ml/fl,oz	1

# Báscula de cocina ECO MÁRMOL



- Tecnología sin pilas ni baterías: se carga mediante el giro de la ruleta.
- Sistema EcoMove: convierte la energía cinética (energía en movimiento) en energía eléctrica.
- Fabricada en cristal templado de 4 mm de grosor y acabado con efecto mármol.
- Diseño extraplano.
- Medición de alta precisión. Capacidad máxima de 5 kg con una división de 1 g.
- Pantalla LCD retroiluminada: facilita la lectura de los datos.
- Muestra los resultados en g (gramos), oz (onzas), lb:oz (onzas líquidas), ml-agua (mililitros- agua) y ml-leche (mililitros-leche).
- Apagado y reseteo automático. Función tara.
- Cuatro pies antideslizantes que proporcionan máxima estabilidad y seguridad.

- Technologie sans batteries ni batteries: elle est chargée par la rotation de la roulette.
- Système Ecomove: convertit l'énergie cinétique (énergie en mouvement) en énergie électrique.
- Fabriqué en verre trempé de 4 mm d'épaisseur et fini avec un effet en marbre.
- Conception d'extraplano.
- Mesure de haute précision. Capacité maximale de 5 kg avec une division de 1 g.
- Écran LCD rétroiluminé: facilite la lecture des données.
- Montre les résultats en g (grammes), oz (onces), LB: oz (onces liquides), ml-eau (milliliters-water) et ml-reche (milliliters -leche).
- Réinitialisation automatique et automatique.
- Fonction Tara
- Quatre pieds non glissants qui offrent une stabilité et une sécurité maximales.

- Technology without batteries or batteries: It is loaded by the rotation of the roulette.
- Ecomove system: converts kinetic energy (energy in motion) into electrical energy.
- Made of temperate glass of 4 mm thick and finish with marble effect.
- Extraplane design.
- High precision measurement. Maximum 5 kg capacity with a 1 g division.
- Retroilluminated LCD screen: Facilitates data reading.
- Shows the results in G (grams), Oz (ounces), lb: oz (liquid ounces), ml-water (milliliters-water) and ml-reche (milliliters -leche).
- Out and automatic reset.
- Tare function
- Four non -slip feet that provide maximum stability and safety.



Sistema EcoMove  
EcoMove system

### Báscula de cocina Eco Mármol

Balance de cuisine · Küchenwaage  
Kitchen scale · Balança de cozinha

Ref	€	cm	División (g)	Peso (Kg)	U. Venta
61720	35,40	19x23,5x3,5	1	5	1

# Básculas de cocina Mecánicas

INOX  
18/10

- Solo uso doméstico, NO comercial.
- Fabricada en acero inoxidable 18/10.
- Permite pesar alimentos de forma cómoda y sencilla.
- No necesita pila.
- Se calibra manualmente.

- Seulement domestique, non commercial.
- Fabriqué en acier inoxydable 18/10.
- Il permet des aliments de manière confortable et simple.
- Il n'a pas besoin d'une bataille.
- Il est calibré manuellement.

- Only domestic, non -commercial.
- Made of stainless steel 18/10.
- It allows foods in a comfortable and simple way.
- It does not need a battle.
- It is manually calibrated.



### Báscula de cocina con bol

Balance de cuisine · Küchenwaage  
Kitchen scale · Balança de cozinha

	Ref	€	Peso (Kg)	División (g)	U. Venta
A	61705	56,70	5	20	1
	61710	58,40	10	50	1
B	61715	88,10	15	50	1

### Báscula de cocina

Balance de cuisine · Küchenwaage  
Kitchen scale · Balança de cozinha

	Ref	€	Peso (Kg)	División (g)	U. Venta
A	61702	20,60	1	5	1
B	61714	38,20	5	20	1

# Básculas de precisión



- Ideal para pesar pequeñas cantidades: levadura, especias, suero, aceite, etc.
- Diseñado para recetas de poco gramaje y alta precisión.

- Idéal pour peser de petites quantités: levure, épices, sérum, huile, etc.
- Conçu pour peu de poids et de recettes de haute précision.

- Ideal to weigh small amounts: yeast, spices, serum, oil, etc.
- Designed for little weight and high precision recipes.

**Muestra los resultados en gramos (g), onzas (oz), onzas troy (ozt) y quilate (ct)**  
Shows the results in grams (g), ounces (oz), troy ounces (ozt) and carat (ct).

**Muestra los resultados en gramos (g) y onzas (oz)**  
Shows the results in grams (g) and ounces (oz)



## Cuchara medidora digital

Cuillère avec Balance Digital · Digitale Löffelwaage  
Digital spoon scale · Colher de pesar Digital

Ref	€	Peso (g)	División (g)	Largo (cm)	U.Venta
62519	40,60	300	0,10	28	1



INOX ABS  
Plastic

## Báscula de precisión

Balance de précision · Präzisionswaage  
Precision scale · Balança de precisão

Ref	€	Peso (Kg)	División (g)	cm	U.Venta
A 61711	18,40	2,00	0,1	12,7x10,6x1,7	1
B 61709	17,60	0,65	0,1	13x8x2	1

# Básculas con gancho

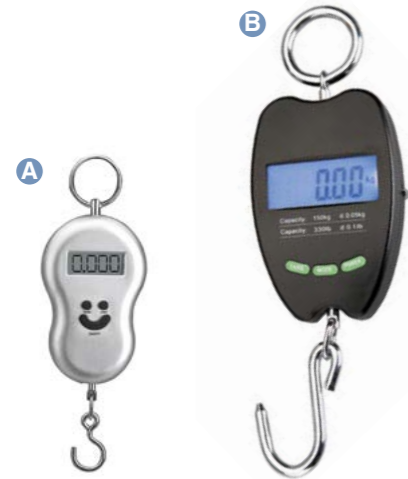

## Báscula con gancho

Balance électronique avec crochet · Elektronischeküchenwaage mit Haken  
Electronic scale w/hook · Balança de gancho

Ref	€	Peso (Kg)	División (g)	U.Venta
A 61721	23,30	10	5	1
B 61722	74,60	0 - 50 50 - 150	20 100	1

# Básculas de baño



## Báscula de baño

Pèse personne · Personenwaage  
Bathroom scale · Escala de banheiro

Ref	€	cm	Peso (Kg)	División (g)	Unidad	U.Venta
61740	34,00	31x31x4	180 (397lb)	100 (0,22lb)	Kg / lb	1



Sistema EcoMove  
EcoMove System



## Báscula de baño Eco

Pèse personne · Personenwaage  
Bathroom scale · Escala de banheiro

Ref	€	cm	Peso (Kg)	División (g)	U.Venta
61742	39,50	31x29x5	180	100	1



INOX

## Báscula de baño Silver

Balance de salle de bain · Badezimmerwaage  
Bathroom scales · Balança para quarto de banho

Ref	€	cm	Peso (Kg)	División (g)	Unidades	U.Venta
61743	27,30	28,5x28,5	180 max	100	kg/lb/st:lb	1

- Tecnología sin pilas ni baterías: se carga pulsando el botón central.
- Sistema EcoMove: convierte la energía cinética (energía en movimiento) en energía eléctrica.
- Fabricada en cristal templado de 5 mm de grosor y acabado con efecto mármol.
- Diseño extraplano.
- Medición de alta precisión: accionado por 4 sensores de peso de máxima precisión.
- Amplio rango de medición, desde los 8 kg hasta los 180 kg (máx.) con una división de 100 g.
- Pantalla LCD retroiluminada: facilita la lectura de los datos.
- Muestra los resultados en Kg (kilogramos) y lb (libras).
- Apagado y reseteo automático.
- Cuatro pies antideslizantes que proporcionan máxima estabilidad y seguridad.

- Technology without batteries or batteries: It is loaded by pressing the central button.
- Ecomove system: converts kinetic energy (energy in motion) into electrical energy.
- Manufactured in temperate glass of 5 mm thick and finish with marble effect.
- Extraplane design.
- High precision measurement: driven by 4 weight sensors of maximum precision.
- Large measurement range, from 8 kg to 180 kg (max.) With a division of 100 g.
- Retroilluminated LCD screen: Facilitates data reading.
- Shows the results in Kg (kilograms) and LB (pounds).
- Out and automatic reset.
- Four non -slip feet that provide maximum stability and safety.

- Báscula de baño digital de alta precisión. Soporta un peso máximo hasta 180 kg con una sensibilidad de 100 g de graduación.
- Diseño extraplano.
- Plataforma de pesaje de cristal templado de seguridad con revestimiento mate antideslizante con una capa antihuellas.
- Equipado con un sistema de sensor de galgas extensométricas de alta precisión.
- Pantalla LCD iluminada de gran tamaño, facilita la visibilidad de la medición.
- Función de encendido y apagado automático e indicador de sobrecarga y de batería baja.
- 4 pies antideslizantes con un agarre extra al suelo que proporcionar una gran seguridad durante su uso y evita deslizamientos.
- Batería: 2 pilas de 1,5 V AAA (incluida).

- High precision digital bathroom scale. Holds a maximum weight up to 180 kg with a sensitivity of 100 g graduation.
- Extra flat design.
- Weighing platform made of tempered safety glass with anti-slip matt coating with anti-fingerprint coating.
- Equipped with a high precision strain gauge sensor system.
- Large illuminated LCD display for easy measurement visibility.
- Automatic on/off function and overload and low battery indicator.
- 4 anti-slip feet with extra grip on the floor provide extra safety during use and prevent slipping.
- Battery: 2 x 1.5 V AAA batteries (included).

# Termómetros de cocina



## Termómetro analógico de Aceite

Thermometre analogique de huile · Analog Thermometer für Öl  
Oil analogic thermometer · Termómetro analógico óleo

Ref	€	cm	Rango temperatura	U.Venta
62495	12,70	5x30,5	40°C (104°F)-200°C (392°F)	1

## Termómetro Dual

Thermomètre · Thermometer  
Thermometer · Termómetro



Ref	€	Rango temperatura	Sonda	U.Venta
62458	106,50	-40°C (-40°F)/230°C (302°F)	-33°C (-27°F)/220°C (428°F)	1

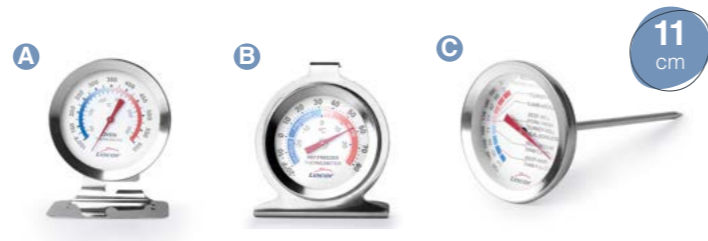

## Termómetro

Thermomètre · Thermometer  
Thermometer · Termómetro

Ref	€	Temperatura	U.Venta
A 62454	10,00	-30°C (-22°F)/30°C (86°F)	1
B 62450	7,80	-54°C (129°F)/88°C (190°F)	1
C 62452	8,40	50°C (122°F)/300°C (572°F)	1

## Termómetro digital Carne

Thermomètre Electronique · Electric Thermometer  
Thermometer, Elektronisch · Termómetro Electrónico



Ref	€	Rango temperatura	U.Venta
62459	21,30	-40°C (-40°F)/150°C (302°F)	1



## Termómetro Digital

Thermomètre numérique · Digital Thermometer  
Digital thermometer · Termómetro Digita

Ref	€	Largo (cm)	Temperatura	U.Venta
A 62487	30,60	23	0°C (-32°F)/300°C (572°F)	1
B 62453	21,20	15	-40°C (-40°F)/150°C (302°F)	1



## Termómetro digital horno

Thermomètre numérique pour le four · Digitaler Ofen-Thermometer  
Oven digital thermometer · Termómetro digital forno

Ref	€	cm	Rango temperatura	U.Venta
62498	50,80	12x7,5	0°C (-32°F) / 300°C (572°F)	1



**NUNCA APUNTE CON EL DISPOSITIVO LOS OJOS DE ALGUIEN**  
He jamais pointer l'instrument vers les yeux de quelqu'un  
Never point the device towards anyone's eyes

## Termómetro infrarrojos Laser

Therm. mesure de surface par infra rouge · Infrarot Thermometer  
Infrared thermometer · Termómetro infravermelhos

Ref	€	Rango temperatura	U.Venta
62457	126,10	-50°C (-58°F) / 400°C (752°F)	1

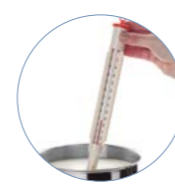

PP

Polypropylene

## Termómetro leche

Thermomètre à lait · Milch Thermometer  
Milk thermometer · Termómetro de leite

Ref	€	Largo (cm)	Rango temperatura	U.Venta
62532	12,10	26,5	-10°C / +110°C	1

# Relojes de cocina



## Reloj cocina con alarma

Minuteur de Cuisine avec Alarme · Küchen-Zeitschaltuhr mit Alarm  
Kitchen Timer Alarm · Relógio de cozinha com alarme

Ref	€	cm	U.Venta
60804	40,00	13x24,5x2,5	1



## Reloj digital

Miniuter Electronique · Digitale Küchen-Zeitschaltuhr mit Alarm  
Digital kitchen timer w/alarm · Relógio digital de cozinha com alarme acústico

Ref	€	cm	Programas	U.Venta
60805	9,20	10,5x7	10	1



## Reloj de cocina magnético

Minuteur de cuisine magnetique · Magnetküchentimer  
Magnetic kitchen timer · Relógio de cozinha magnetico

Ref	€	cm	Tiempo	U.Venta
60803	11,10	9,2x3,5	60 min	1



Soporte plegable.  
Potente imán  
Folding stand.  
Powerful magnet

## Reloj cocina White

Minuteur de Cuisine avec Alarme · Küchen-Zeitschaltuhr mit Alarm  
Kitchen Timer Alarm · Relógio de cozinha com alarme

Ref	€	cm	U.Venta
60802	20,10	7x1,4x5,1	1

# Profesional Collection

INOX   
Dishwasher



## Utensilios de corte Cutting utensils



**Cortador de bolas**  
Cuillere à pommes · Kugelausstecher  
Fruit baller · Cortador bolas

Ref	€	Ø (mm)	U.Venta
60366	7,80	15	1
60367	7,90	20	1
60368	7,90	25	1
60369	8,00	30	1



**Cortador de bolas rizado**  
Cuillere à pommes forme oval canelée ·  
Kugelausstecher oval, gerippt  
Fruit baller oval fluted · Cortador bolas oval frizado

Ref	€	mm	U.Venta
60372	8,70	20x32,5	1



**Cuchillo vaciador**  
Couteau pour fruits · Frucht messer  
Fruit knife · Faca para fruta

Ref	€	mm	U.Venta
60399	6,20	20x105	1



**Pelapatatas Y**  
Éplucheur "Y" · "Y" Schäler  
"Y" Peeler · Pela-batatas "Y"

Ref	€	mm	U.Venta
60377	9,80	55x55	1
60378	10,40	55x55	1

Liso  
Plane  
Dentado  
Serrated



**Pelapatatas P**  
Éplucheur "P" · "P" Schäler  
"P" Peeler · Pela-batatas "P"

Ref	€	mm	U.Venta
60380	6,80	16x55	1



**Pelador cuchillas fija**  
Éplucheur lame fixe · Schäler Messerfix  
Fix blade peeler · Pela-batatas lâmina fixa

Ref	€	mm	U.Venta
60398	5,30	15x75	1





# Luxe Collection

INOX   
Dishwasher



**Cuchillo para queso**  
Couteaux à fromage · Käsemesser  
Cheese knife kitchen tool · Faca para queijo

Ref	€	cm	Largo (cm)	U.Venta
62675	11,70	14	28	6



**Espátula lisa**  
Spatule lisse · Backschaufel  
Spatula · Espátula

Ref	€	cm	Largo (cm)	U.Venta
62676	10,00	4,3x11	25	6



**Descorazonador**  
Vide-pommes · Apfelenkerner  
Aple corer · Descaroçador

Ref	€	cm	Largo (cm)	U.Venta
62686	10,20	2x2	20	6



**Cortador de bolas**  
Cuillère à pommes · Kugelausstecher  
Fruit baller · Cortador de bolas

Ref	€	cm	Largo (cm)	U.Venta
62683	9,10	3x1	19	6



**Pelapatatas "Y"**  
Éplucheur "Y" · "Y" Schäler  
"Y" Peeler · Descascador de batatas "Y"

Ref	€	cm	Largo (cm)	U.Venta
62687	11,90	5x2	18	6



**Pelapatatas "P"**  
Éplucheur "P" · "P" Schäler  
"P" Peeler · Descascador de batatas "P"

Ref	€	cm	Largo (cm)	U.Venta
62688	10,90	2x1	20	6



**Pala pastel serrada**  
Palette à gâteau dentellé · Kuchenschaufel  
Serrated cake shovel · Espátula de bolos c/serrilha

Ref	€	cm	Largo (cm)	U.Venta
62673	12,90	5,5x13	26	6



**Abre ostras**  
Couteau à huîtres · Austermesser  
Oyster opener · Aberto-ostras

Ref	€	Largo (cm)	U.Venta
62684	12,90	20	1



**Prensa ajos**  
Presse-pail · Knoblauchpresse  
Garlic press · Esmaga-alhos

Ref	€	cm	Largo (cm)	U.Venta
62685	24,70	3x5	18	6

**Abrelatas**  
Ouvre-boîte · Dosenöffner  
Can opener · Abre-latas



Ref	€	cm	Largo (cm)	U.Venta
62689	27,20	5x4	20	6

# Peladores

INOX   
Dishwasher



**Pelador tomate dentado P Red**  
Épluche tomates à dents P · Tomatenschäler, gezackt, P  
P Serrated tomato peeler · Pelador tomate dentado P

Ref	€	Largo (cm)	U.Venta
60351	14,70	19,5	1



**Pelador tomate dentado Y Red**  
Épluche tomates à dents Y · Tomatenschäler, gezackt, Y  
Y Serrated tomato peeler · Pelador tomate dentado Y

Ref	€	Largo (cm)	U.Venta
60352	14,40	17,5	1



**Descorazonador Red**  
Vide tomates · Tomatenentkerner  
Tomato core remover · Descaraçador

Ref	€	Largo (cm)	U.Venta
60353	11,00	16,5	1



**Cuchillo dentado Red**  
Couteau à dents à tomates · Tomatenmesser, gezahnt  
Serrated tomato knife · Faca dentada

Ref	€	Largo (cm)	U.Venta
60354	10,90	22	1



**Pelador liso Red**  
Éplucheuse plate · Normalen Schäler  
Peeler plain blade · Descascador liso

Ref	€	Largo (cm)	U.Venta
60547	11,20	12,5	1



**Pelador Inox**  
Éplucheuse · Schäler  
Peeler · Descascador

Ref	€	cm	U.Venta	
60346	12,20	5,5x12	1	Liso · Line
60347	12,20	5,5x12	1	Dentado Serrated



**Pelador Unite**  
Éplucheuse · Schäler  
Peeler · Descascador

Ref	€	Largo (cm)	U.Venta	
68197	4,30	14,5	1	Liso Plane
68198	4,30	14,5	1	Dentado Serrated



**Pelador cerámico Y**  
Éplucheuse en céramique Y · Y Schäler, Keramik  
Y ceramic peeler · Descascador cerâmico Y

Ref	€	cm	U.Venta
60444	4,10	8,5x16,5	6



**Pelador Y cuchillas giratorias**  
Éplucheuse "Y" lames tournantes · "Y" Schäler, rotierende Messer  
"Y" type peeler rotating blades · Descascador "Y" lâminas giratorias

Ref	€	Largo (cm)	U.Venta
60389	24,10	20	1



ABS Plastic INOX BPA free

INOX TPE Plastic BPA free

### Pelador de aguacate

Coupe avocat · Schäler avocado  
Avocado peeler · Descascador abacate

Ref	€	cm	U.Venta
61355	8,80	28x4	1

### Laminador de aguacate

Éplucheuse avocats · Schäler avocados  
Avocado slicer · Descascador abacater

Ref	€	cm	Largo (cm)	U.Venta
61353	12,10	6,2	24	1



INOX ABS Plastic BPA free

### Pelador de piña

Set coupe ananas · Ananas-Schäler  
Pineapple peeler · Pelador de ananas

Ref	€	Ø (cm)	h(cm)	U.Venta
60392	11,60	10	23	4

### Pelador de piña Slize

Set coupe ananas · Ananas-Schäler  
Pineapple peeler · Pelador de ananas

Ref	€	Ø (cm)	h(cm)	U.Venta
68806	3,90	9	24	1



INOX ABS Plastic

### Juego cortador-pelador piña

Jeu couteau et éplucheur ananas · Messer und Schäler set für ananas  
Set pineapple cutter-peeler with canister · Jogo cortador e descascador de ananas

Ref	€	Ø (cm)	U.Venta
60393	25,30	9	1



# Picadoras

INOX 18/10



- Picadora de mecanismo manual que pica todo tipo de alimentos, como verduras, frutas, jengibre, ajo, cebolla, frutos secos y hierbas.
- Cuchilla de acero inoxidable de máxima calidad.
- Recipiente transparente para visualizar el proceso. Libre de BPA.
- Muy fácil y cómodo de usar gracias a su sistema manual PressTurn.
- Tapa de polietileno antideslizante para facilitar la tarea y evitar desplazamientos.
- Fácil de desmontar y limpiar.

- Choppeur de mécanisme manuel qui démange tous les types de nourriture, comme les légumes, les fruits, le gingembre, l'ail, l'oignon, les noix et les herbes.
- Lame en acier inoxydable de qualité maximale.
- Conteneur transparent pour visualiser le processus. Sans BPA.
- Très facile et confortable à utiliser grâce à son système manuel PressTurn.
- Couverture en polyéthylène non glissé pour faciliter la tâche et éviter les déplacements.
- Facile à démanteler et à nettoyer.

- Manual mechanism chopper that itch all types of food, such as vegetables, fruits, ginger, garlic, onion, nuts and herbs.
- Maximum quality stainless steel blade.
- Transparent container to visualize the process. BPA free.
- Very easy and comfortable to use thanks to its pressturn manual system.
- Non-slip polyethylene lid to facilitate task and avoid displacements.
- Easy to disassemble and clean.



### Picadora manual Inox

Hachoir manuel · Handschneider  
Manual food chopper · Picador manual

Ref	€	Ø (cm)	h(cm)	U.Venta
62980	32,80	9,5	22	6



### Picaperejil

Hachoir à manivelle pour fines herbes · Kräutermühle, fein  
St. steel fine herbs mincer · Pica-salsa

Ref	€	cm	U.Venta
60334	22,90	13,5x20x7,5	1

### Multifuncional: pica, bate y centrifuga

Mecanismo de manivela que requiere muy poca fuerza  
Multifunctional: chop, beat and spin  
Crank mechanism requiring very little force

### Sistema TurnCut

Accionamiento manual de la manivela 100% estable. Sujeción mediante ventosa  
TurnCut System  
Manual crank operation  
100% stable. Suction cup fastening



INOX

### Picadora de carne manual

Hachoir avec manivelle · Fleischwolf mit handkurbe  
Meat mincer · Picadora de carne manual

Ref	€	cm	U.Venta
60329	127,20	17x12x19	1



### Mini picadora-batidora manual

Mini hachoir-fouet manuel · Minizerhacker-Schneebesen  
Manual mini chooper-whisk · Mini picadora-batedeida manual

Ref	€	Ø (cm)	L	U.Venta
60361	18,60	Ø17x18	1,00	1



INOX 18/10 ABS Plastic Dishwasher BPA free

### Picadora White

Hachoir avec manivelle · Fleischwolf mit handkurbe  
Meat mincer · Picadora de carne manual

Ref	€	cm	U.Venta
60340	35,60	18x22	1

# Garras de oso

INOX BAQUELITA Dishwasher  
Bakelite Dishwasher



**Manipula carnes. Desmenuza carnes**

Manipulate meat. Crumble meats

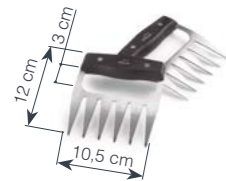

## Garras de oso

Griffes à viande · Fleisch Bärenkrallen  
Bear claws for meat · Garras de urso para carne

Ref	€	cm	U.Venta
38015	13,00	10,5x12	1

- Fabricadas en acero inoxidable de máxima calidad.
- Diseñadas para desmenuzar y manipular carnes hechas al horno o barbacoa, como pollo, carne de vacuno, pavo, aves, jamón, etc.
- Puntas afiladas para manipular la carne sin esfuerzo. Forma curvada para un mejor agarre y mayor comodidad.
- Mangos ergonómicos de baquelita resistentes al calor, 100% seguros.
- Multifuncional: desmenuza y traslada la carne, facilita la sujeción para cortes con cuchillo, remueve las ensaladas o pastas, etc.
- Fácil de limpiar. Apts para el lavavajillas.

- Fabriqué en acier inoxydable de qualité maximale.
- Conçu pour s'effondrer et manipuler la viande de viande, comme le poulet, le bœuf, la dinde, les oiseaux, le jambon, etc.
- Des conseils pointus pour gérer la viande sans effort. Forme incurvée pour une meilleure adhérence et un plus grand confort.
- Mangues de baquelite ergonomiques résistantes à la chaleur, 100% d'assurance.
- Multifonctionnel: s'effondre et déplace la viande, facilite la fixation des coupures de couteau, retirer les salades ou les pâtes, etc.
- Facile à nettoyer. Convient au lave-vaisselle.

- Manufactured in maximum quality stainless steel.
- Designed to crumble and handle meat -made meats, such as chicken, beef, turkey, birds, ham, etc.
- Sharp tips to handle meat effortlessly. Curved form for a better grip and greater comfort.
- Ergonomic baquelite mangoes resistant to heat, 100% insurance.
- Multifunctional: crumbles and moves the meat, facilitates the fastening for knife cuts, remove salads or pasta, etc.
- Easy to clean. Suitable for dishwasher.



# Cortadores

INOX Dishwasher BPA free



## Cortador manual Affilato

Coupe manuel · Manuelle Schneider  
Manual chopper · Cortador manual

Ref	€	Ø (cm)	h(cm)	L	U.Venta
60599	25,60	13	14	1,2	1



**Velocidad I · Speed I**  
Corta y pica más grueso  
Cut and chopp more coarsely



**Velocidad II · Speed II**  
Corta y pica más fino  
Cut and chopp more finely



**Corta alimentos duros**  
It cuts thicker foods



**Corta alimentos blandos**  
It cuts softer foods



**Cuchillas ultrarresistentes**  
Ultra-strongs blades



## Cortador manual Sharp

Coupe manuel · Manueller Schneider  
Manual cutter · Cortador manual

Ref	€	Ø (cm)	Cuchillas	h(cm)	L	U.Venta
60299	21,70	12	3	11	0,5	1
60499	23,00	13	5	14	1,0	1

**Pica y corta alimentos en segundos**  
It chops and slices foods in seconds



**3 cuchillas (6 - 9 - Rodajas 6 mm)**

**2 empujadores**

**Peines de limpieza**

3 blades (6 - 9 - Slice 6 mm)

2 pushers

Cleaning combs



**Corte en rodajas y juliana**  
Sliced and julienne cut



## Cortador de verduras y chips

Coupe de légumes · Gemüseschneidemachine  
Chips and vegetable cutter · Cortador de verdura e chips

Ref	€	cm	h(cm)	Cuchillas	U.Venta
60344	46,50	11,5x21,5	11	3	1



INOX 18/10 PP Polypropylene BPA free

### Cortador de patatas Hasselback

Coupe-pommes de terre Hasselback · Hasselback-Kartoffelschneider  
Hasselback potato slicer · Cortador de batatas Hasselback

Ref	€	cm	h(cm)	U.Venta
68180	9,90	18x10	2,1	1



### Cortador de patatas ondulado

Coupe-frites ondulé · Kartoffel-Wellenschneider  
Crinkle cut potato slicer · Cortador de batatas ondulado

Ref	€	cm	h(cm)	U.Venta
62895	3,00	14x9,5	2	1



### Cortahuevos

Coupe-oeuf · Eirschneider  
Egg cutter · Corta-ovos

Ref	€	Ø (cm)	U.Venta
A 68305	20,50	7	1
B 68306	18,50	10	12
C 68307	36,50	15x10x3,7	1



### Cortador en espiral espagueti

Coupe en spirale · Spiralschneider  
Spiral cutter · Cortador em espiral

Ref	€	Diámetro interior (cm)	Cuchilla (cm)	U.Venta
60529	4,10	8	5,5	6



ABS Plastic

### Deshojador de hierbas aromáticas

Effeulleuse à herbes aromatiques · Entblätterer für gewürzkräuter  
Aromatic herb stripper · Desfolhador de ervas aromáticas

Ref	€	cm	U.Venta
61359	6,70	16,5x7,5x2	1



### Cortador de verduras Double

Hachoir de légumes double manuel · Doppelschneidiges Hand Wiegemesser  
Vegetables manual double blade chopper · Corta verduras manual duplo lâmina

Ref	€	cm	U.Venta
60365	17,00	17x2	10



### Cortador en espiral manual

Coupe en spirale manuelle · Manueller Spiralschneider  
Manual spiral cutter · Cortador em espiral manual

Ref	€	Ø (cm)	h(cm)	L	U.Venta
60524	19,10	9	22	0,40	1



INOX BPA free

### Descorazonador manual

Vide-pommes manuel · Apfelnkerner  
Manual apple corer · Descorçador manual

Ref	€	U.Venta
60350	7,90	1

INOX PP Polypropylene BPA free

### Corta melones-sandías

Trancheur à melons · Wassermelonen-Schneider  
Melon cutter-watermelon · Corte os melões-melancia

Ref	€	Ø (cm)	U.Venta
60397	20,60	25,8	1

Guían el cuchillo para un corte perfecto y uniforme  
Guide the knife for perfect and even slicing



### Peine cortacarne

Peigne pour coupe viande · Fleischzange  
Meat tong · Pinça/pente corta-carne

Ref	€	cm	h (cm)	U.Venta
60336	20,20	11x30	6,5	6



INOX 18/10

### Cortabacalao

Couper la morue · Kabeljau-Schneider  
Cut cod · Corta-bacalhau

Ref	€	cm	U.Venta
60000	248,30	11x58,5x8	1



INOX 18/10

### Cortaquesos cuchilla

Coupe-fromage avec lame · Käsemesser, mit Klinge  
Cheese cutter with blade · Corta-queijos lâmina

Ref	€	cm	h(cm)	U.Venta
60005	29,60	27,5x21	3	1

Cuchilla de 6 cm de largo  
6 cm long blade



INOX 18/10

### Laminador de trufa

Coupe-Truffles · Truffelschneider  
Truffle-slicer · Laminador trufa

Ref	€	Largo (cm)	U.Venta
61351	14,80	18	1

Regular de grosor  
Regular thickness



### Cortador de queso fresco

Fromage coupe fil · Draht-Käseschneider  
Cheese wire cutter · Corta-queijos

Ref	€	cm	U.Venta
60004	4,90	17	12
60009	5,40	21	12

## Triturador tomate

INOX ABS Plastic SAN Plastic LDPE Polyethylene BPA free



Salida para desechos  
Outlet for waste

### Triturador de tomate

Trancheur à melons · Wassermelonen-Schneider  
Melon cutter-watermelon · Corte os melões-melancia

Ref	€	U.Venta
60394	48,50	1



# Ralladores

INOX  
Dishwasher



ABS Plastic PS Plastic BPA free

## Rallador 4 caras KEEP

Râpe 4 faces avec récipient · 4-seitige Reibe  
4-sided grater with container · Ralador 4 lados c/recipiente

Ref	€	cm	h(cm)	U.Venta
61363	6,30	8,9X6,5	20,5	6

HAYA Wood



## Rallador 4 caras Wood

Râpe 4 faces · 4-seitige Reibe  
4-sided grater · Ralador 4 lados

Ref	€	cm	h(cm)	U.Venta
A 61364	11,30	11x8,5	24,8	1
B 61365	9,30	9x6,5	22,0	1

INOX 18/10



## Rallador Multi

Râpe · Reibe  
Grater · Ralador

Ref	€	h (cm)	U.Venta
A 60307	16,50	23	6
B 60305	7,20	24	6



## Rallador Luxe

Râpe · Reibe  
Grater · Ralador

Ref	€	h(cm)	U.Venta
61354	28,60	23,5	1



## Rallador con manivela Inox

Hachoir en inox · Käsereiber, Rostfrei  
St.steel cheese grater · Ralador inox com manivela

Ref	€	cm	U.Venta
60335	35,30	13,5x20x10	1



## Rallador de limón

Râpe muscade · Zitronenreibe  
Grater semi-circular · Ralador de limão

Ref	€	cm	U.Venta
67008	6,20	23x6	12



## Rallador plano 3 usos

Râpe plat · Reibe 3 Nützlichkeit  
Grater 3 uses · Ralador plano 3 usos

Ref	€	cm	U.Venta
60301	7,80	25,5x11	12



## Rallador plano paso grueso

Râpe plat · Reibe, grob  
Grater big hole · Ralador plano passo grosso

Ref	€	cm	U.Venta
60302	7,80	25,5x11	12



## Rallador plano paso fino

Râpe plat · Reibe, fein  
Grater small hole · Ralador plano passo fino

Ref	€	cm	U.Venta
60303	7,80	25,5x11	12



## Rallador especias mini

Râpe à épices mini · Mini-Reibe Gewürze  
Mini spices grater · Ralador especiarias mini

Ref	€	cm	U.Venta
67032	3,70	11x7	6



## Rallador nuez moscada

Râpe à muscade · Musket Reibe  
Nutmeg grater · Ralador noz-moscada

Ref	€	cm	U.Venta
67031	10,60	4,5x3	12



## Rallador nuez moscada mini

Râpe à noix de muscade mini · Mini-Musket Reibe  
Mini nutmeg grater · Ralador noz-moscada mini

Ref	€	U.Venta
67009	2,20	12



## Rallador Dual

Râpe · Reibe  
Grater · Ralador

Ref	€	Largo (cm)	U.Venta
61360	10,40	31,0	6



## Rallador inox black

Râpe · Reibe  
Grater · Ralador

Ref	€	U.Venta
A 61341	16,00	1
B 61342	16,00	1
C 61343	16,00	1
D 61344	16,00	1

Extra fino · Extra thin

Fino · Thin

Grueso · Thick

Juliana · Julienne



## Rallador inox black Largo

Râpe longue · Reibe, lang  
Lengthways grater · Ralador comprimo

Ref	€	U.Venta
A 61346	16,00	1
B 61347	16,00	1
C 61348	16,00	1
D 61349	16,00	1

Fino · Thin

Medio · Medium

Grueso · Thick

Fino+Medio · Thin+Medium



## Rallador decorador multiusos

Râpe pour décoration multi-usages  
Mehrzweckreibe zum Verzieren  
Multipurpose zester · Ralador decorador multiusos

Ref	€	Largo (cm)	U.Venta
63911	11,60	18,0	1



4 in 1

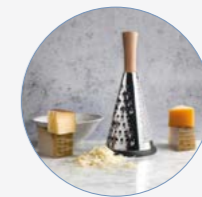

INOX HAYA Wood



## Rallador Cónico

Râpe ronde · Reibe, Konisch  
Conical grater · Ralador cónico

Ref	€	Ø (cm)	h (cm)	U.Venta
61366	5,60	12	27	1

# Mandolinas

ABS Plastic Dishwasher BPA free

Plegable Bloqueo de seguridad Fold up Safety lock position



- Ahorra tiempo gracias a su corte fácil, rápido y seguro.
- Su cuchilla extremadamente afilada proporciona un corte homogéneo y preciso.
- Tipo de corte:
  - Corte liso/rodajas regulable de 0,5 - 8 mm
  - Corte en juliana 8 mm
  - Corte en juliana 4 mm
  - Corte en cubos (excepto ref.: 60560).
- Corte por accionamiento vertical con una palanca de retroceso automático.
- Amplia capacidad del depósito de alimentación posibilidad de meter alimentos grandes o más de uno.
- Protector contra cortes, no hay contacto directo con las manos durante su uso.
- Dispone de un contenedor que recoge los alimentos cortados.
- Ocupa poco espacio, se pliegan el pie y se recoge el mango.
- Palanca con posición de bloqueo de seguridad, muy seguro para su transporte y almacenaje.

- Gagnez du temps grâce à son système de coupe facile, rapide et sûr
- Sa lame extrêmement affilée confère une coupe homogène et précise
- Types de coupe :
  - Coupe lisse/rondelles à épaisseur variable de 0,5 à 8 mm.
  - Coupe en julienne 4 mm.
  - Coupe en julienne 8 mm
  - Découpage en cubes (sauf réf. : 60560).

- Coupe par actionnement vertical avec un levier à retour automatique
- Grande capacité de la trémie d'alimentation : possibilité de mettre de gros aliments ou plus d'un aliment.
- Protection anti-coupures. Pas de contact direct avec les mains pendant l'utilisation
- Dispose d'un conteneur qui recueille les aliments coupés
- Prend peu de place. Pied pliable et manche rabattable
- Levier avec position de blocage de sécurité, très sûr pour le transport et le rangement

- Saves time thanks to its easy, fast and safe cutting
- It's extremely sharp blade enables even and precise cutting
- Type of cut:
  - Smooth cut/adjustable slices from 0.5 - 8 mm
  - Julienne cut 4 mm
  - Julienne cut 8 mm
  - Cutting into cubes (except ref.: 60560).
- Vertically operated cutting with an automatic recoil lever
- Large capacity of the feed hopper (9x10 cm) possibility to put large feed or more than one feed.
- Anti-cut protector; no direct contact with hands during use
- Includes a container that collects the chopped food
- Takes up little space as the legs fold up and the handle pushes in
- Lever with safety lock position; very safe for transport and storage

### 3 tipos de corte · 3 types of cut

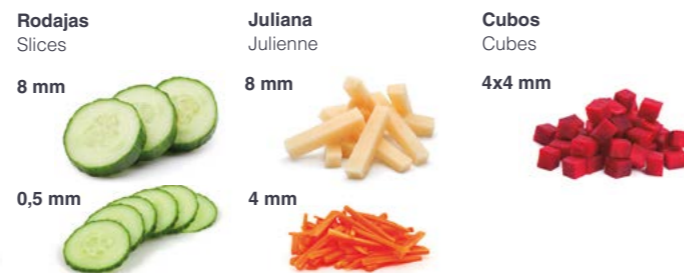

## Mandolina vertical

Mandoline verticale · Mandoline, Vertikale  
Vertical mandoline · Mandolina vertical

Ref	€	Rodaja (mm)	Juliana (mm)	Cubos (mm)	U.Venta
60460	41,30	0,5 - 8	4 - 8	8x8 / 0,5x4	1



## Mandolina vertical Plus

Mandoline verticale · Mandoline, Vertikale  
Vertical mandoline · Mandolina vertical

Ref	€	cm	h(cm)	U.Venta
60860	62,10	31x14	31	1

garinox®



## Mandolina vertical Precis

Mandoline verticale · Mandoline, Vertikale  
Vertical mandoline · Mandolina vertical

Ref	€	Rodaja (mm)	Juliana (mm)	U.Venta
60560	21,20	2 - 4	4 - 8	1



8 Funciones Functions

5 Cuchillas Blades

## Mandolina Multi

Mandoline · Mandoline  
Mandoline · Mandolina

Ref	€	cm	Cuchillas	U.Venta
60331	31,70	14,5x34,5	5	1



5 Cuchillas Blades

## Mandolina Luxe

Mandoline · Mandoline  
Mandoline · Mandolina

Ref	€	cm	Cuchillas	U.Venta
60332	120,30	14x42	5	1



8 Funciones Functions

5 Cuchillas Blades

## Mandolina V

Mandoline · Mandoline  
Mandoline · Mandolina

Ref	€	cm	Cuchillas	U.Venta
60356	39,00	13x33,5	5	1



Cuchillas giratorias Rotating blades

## Mandolina Safe

Mandoline · Mandoline  
Mandoline · Mandolina

Ref	€	cm	Cuchillas	U.Venta
60357	130,30	12,5x50	4	1

Click here



## Mandolina bidireccional Lisa Fast

Mandoline double coupè · Mandoline double schneider  
Dual slice mandoline · Mandolina duplo corte

Ref	€	cm	U.Venta
60275	14,30	14x42	1

## Mandolina bidireccional juliana Fast

Mandoline double coupè · Mandoline double schneider  
Dual slice mandoline · Mandolina duplo corte

Ref	€	cm	U.Venta
60276	15,40	14x42	1

- Mandolina bidireccional con cuchilla de acero inoxidable y cuerpo fabricado en materiales de máxima calidad, libres de BPA.
- Cuchillas extremadamente afiladas que proporcionan un corte homogéneo y preciso.
- Dos tipos de corte: fino de 1 mm y grueso de 3 mm (Ref.: 60275). Corte en Juliana de 3x3 mm de sección (Ref.: 60276).
- Diseño práctico y compacto.
- Corte seguro: base antideslizante y protector de dedos ergonómico que evita el contacto con las cuchillas durante el uso.
- Rampa de deslizamiento con superficie acanalada para evitar que se peguen los alimentos.
- Fácil de limpiar, cuchilla desmontable

- Bidirectional mandoline with a stainless steel blade and body made of top quality, BPA free materials.
- Extremely sharp blades that give an even and precise cut.
- Two types of cut: 1 mm thin and 3 mm thick (Ref.: 60275). Julienne cut of 3x3 mm section (Ref.: 60276).
- Practical and compact design.
- DoubleCut System: Save up to 50% time because it cuts in both directions.
- Safe Cut: Non-slip base and ergonomic finger guard that prevents contact with the blades during use.
- Sliding ramp with a corrugated surface that keeps food from sticking.
- Easy to clean, removable blade.

# Máquinas de corte



- Aumenta la productividad disminuyendo el tiempo de trabajo frente a sistemas convencionales.
- Gama de corte profesional con 4 modelos de corte manual. Con un diseño robusto y ergonómico, gracias a sus cuchillas de acero inoxidable (resistentes a la corrosión), aseguran un corte uniforme y de gran calidad. Ideales para cualquier cocina industrial, su fácil manejo permite obtener un óptimo rendimiento con el mínimo esfuerzo.

- Augmente la productivité et diminue le temps de travail par rapport aux systèmes conventionnels.
- Gamme de coupe professionnelle avec 4 modèles de coupe manuelle. Avec une conception robuste et ergonomique, notamment grâce aux lames en acier inoxydable (résistantes à la corrosion), ils garantissent une coupe uniforme et de grande qualité. Ils s'adaptent parfaitement aux différents types de cuisine industrielle et la facilité de manipulation permet d'obtenir un rendement optimal avec le moindre effort.

- Increases productivity by reducing working time when compared to conventional systems.
- Range of professional cutting Utensils with 4 manual cutting models. With a robust and ergonomic design, its stainless steel (corrosion resistant) blades ensure a smooth and high quality cut. Ideal for any Industrial kitchen, their ease of use enables optimum performance with minimum effort.

- Asa de gran robustez para transportar la máquina.
- 10 cuchillas para un perfecto laminado.
- Bandeja recogelimitos. Ventosas de sujeción.

- Colóquelo donde quiera (mesa-pared-tabla).
- 4 cuchillas diferentes: 7x7 mm / 10x10 mm / 15x15 mm / 8 gajos.
- Estructura desmontable y fácil limpieza.

- Great robustness handle to transport the machine.
- 10 blades for a perfect laminate.
- Collection tray. Suction suction.

- Place wherever (table-play-table).
- 4 Different Cuchlas: 7x7 mm / 10x10 mm / 15x15 mm / 8 segments.
- Structure Disassemble and easy cleaning.



## Máquina corta tomates

Machine pour couper tomates · Tomatenschneider  
Tomato cutter machine · Máquina cortador tomate

Ref	€	Espesor corte	cm	U.Venta
60510	254,80	5,5	43x20x21	1

- Colóquelo donde quiera (mesa-encimera-tabla).
- 3 cuchillas diferentes; 6x6 mm / 8x8 mm / 10x10 mm.
- Estructura desmontable y fácil limpieza.

- Place it wherever you want (Table-Encimera-Tabla).
- 3 different blades; 6x6 mm / 8x8 mm / 10x10 mm.
- Detachable structure and easy cleaning.

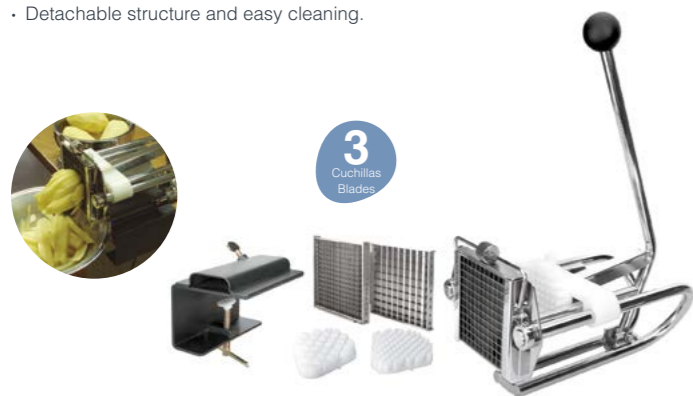

## Corta patatas chips

Coupe-Frites 3 Lames · Pommes Frites-Schneider, 3 Klingens  
Potato Chips Cutter 3 Blades · Corta-batatas chip 3 cortadores

Ref	€	Cubos (mm)	U.Venta
60343	216,20	6x6 / 8x8 / 10x10	1



## Máquina corta patatas y gajos

Machine pour chips trancheuse et wedger · Pommes Frites und Wedger-Schneider  
Potato chips slicer and wedger machine · Máquina cortador batatas e gomos

Ref	€	Cubos (mm)	Gajos	cm	U.Venta
60513	229,50	7x7 / 10x10 / 15x15	8	26x26x42	1

- Amortiguadores para evitar golpes al cortar los alimentos.
- Asa empujador robusta para un mejor manejo.
- Patas de goma para una mejor sujeción.

- Shock absorbers to avoid blows when cutting food.
- Robust pushing for better handling.
- Rubber legs for better support.



## Máquina corta patatas vertical

Machine pour chips trancheuse vertical · Pommes Frites-Schneider vertikal  
Vertical chips slicer machine · Máquina cortador batatas vertical

Ref	€	Cubos (mm)	cm	h(cm)	U.Venta
60511	181,70	10x10	20x20	48	1

# Guillotina para embutidos



## Guillotina para embutidos

Guillotine à saucisson · Wurtschneider  
Cold meat guillotine · Guillotina para embutidos

Ref	€	cm	h(cm)	U.Venta
60559	21,80	29x19	10,5	1

- Diseñada para cortar y rebanar todo tipo de embutidos (Ø 5,5 cm máx.) de forma rápida, segura y sin esfuerzo.
- Cuchilla de acero inoxidable muy aillada de máxima calidad.
- Mango ergonómico que garantiza un agarre fácil y cómodo.
- Máxima seguridad gracias al pasador protector con imán.
- 100% estable. Dispone de 7 almohadillas de goma antideslizantes en la base.

- Conçu pour couper et trancher toutes sortes de saucisses (Ø 5,5 cm max.) Rapidement, en toute sécurité et sans effort.
- Blade en acier inoxydable très Aillada de qualité maximale.
- Mango ergonomique qui garantit une poignée facile et confortable.
- Sécurité maximale grâce à la broche de protection avec aimant.
- 100% stable. Il a 7 coussinets en caoutchouc non glissants à la base.

- Designed to cut and slice all kinds of sausages (Ø 5.5 cm max.) Quickly, safely and effortlessly.
- Very aillada stainless steel blade of maximum quality.
- Ergonomic mango that guarantees an easy and comfortable grip.
- Maximum security thanks to the protective pin with magnet.
- 100% stable. It has 7 non-slip rubber pads at the base.

# Jamonero



Tacos antideslizantes  
Non slip plugs

## Jamonero

Support pour jambon · Schinkenhalter  
Ham-support · Suporte presunto

Ref	€	cm	h(cm)	U.Venta
62344	94,40	50x20,5	35,5	1



Plegable  
Folding

Tacos antideslizantes  
Non slip plugs

## Jamonero abatible

Support pour jambon rabattable · Schinkenhalter, Verstellbar  
Folden ham-support · Suporte presunto abatible

Ref	€	cm	h(cm)	U.Venta
62359	92,80	43x19	5	1

# Tabla de corte Carnicero

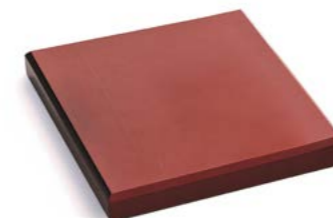

- Fabricada en polietileno de alta densidad. Espesor de 5 mm.
- Su dureza le confiere una mayor resistencia a la abrasión, durabilidad y una gran absorción de los golpes.
- Material no poroso que facilita su limpieza. No acumula olores ni sabores.
- Apta para lavavajillas.
- Cumple con todas las garantías sanitarias para la manipulación de alimentos exigidas por la unión europea.

- Fabriqué en polyéthylène de haute densité. Épaisseur de 5 mm.
- Sa dureté lui confère une plus grande résistance à l'abrasion, et une durabilité et une absorption des chocs accrues.
- Matériau non poreux qui facilite son nettoyage. Ne garde ni les odeurs ni les goûts.
- Apte pour le lave-vaisselle.
- Répond à toutes les garanties sanitaires pour la manipulation d'aliments exigées par l'Union Européenne.

## Tabla de corte Carnicero

Planche à découper la viande · Metzger-Schneidblock  
Butcher Block · Cepo de corte de carneiro

Ref	€	cm	h(cm)	U.Venta
60578	179,30	50x50	5,0	1

- Made of high density polyethylene 5 mm thick.
- Its hardness gives it greater resistance to abrasion, more durability and high impact absorption.
- The non-porous material makes it easy to clean. There is no build-up of odours or flavours.
- Dishwasher safe.
- Meets all health guarantee for food handling required by the European Union.

# Protección guantes y delantal

**Composición** · Composition:  
62% Polietileno / 62% Polyethylene  
24% Poliéster / 24% Polyester  
14% Fibra de vidrio / 14% Glass fiber

2  
PCS



## Guante protección

Gant de protection · Schutzhandschuh  
Protection glove · Luva de protecção

Ref	€	Talla	Medidas	Perímetro mano	Largo (cm)	U.Venta
61101	20,00	M	8	182 mm	24	1
61102	20,00	L	9	192 mm	25	1
61103	20,00	XL	10	204 mm	26	1

INOX

## Guante Cota

Gant en maille · Netz-Handschuh  
Chainmail glove · Luva de malha

Ref	€	Talla	Medidas	Perímetro mano	Color	U.Venta
39169	142,90	S	7	171 mm	Blanco · White	1
39170	142,90	M	8	182 mm	Rojo · Red	1
39171	142,90	L	9	192 mm	Azul · Blue	1
39172	142,90	XL	10	204 mm	Naranja · Orange	1

INOX

## Delantal cota de malla

Tablier en maille · Kettenhemb Schürze  
Metal butcher's apron · Avental de malha

Ref	€	cm	Perímetro (cm)	U.Venta
39165	331,20	80x55	95-145	1



EN 388:2016+1:2018



CE certificate issued by CTC FRANCE

Resistencia a la abrasión  
Abrasion resistance **3**

Resistencia al corte  
Blade cut resistance **4**

Resistencia al PDM  
PDM resistance **C**

Resistencia al desgarro  
Tear resistance **4**

- Ambidiestros, cómodo y ligero.
- **NO** emplear con sierras giratorias o dentadas.

- Ambidextres, pratiques et légers.
- **NE PAS** utiliser avec des scies giratoires ou dentées.

- Ambidextrous, comfortable and light.
- Do **NOT** use with rotating or toothed saws.



UNE EN 1082

CE Directive 89/686/EEC and EN 1082-1-1996

- Guante de cinco dedos con correa en la muñeca.
- Reversible para mano derecha como izquierda.
- Diseño de correa extraíble y protección completa de mano.
- Fácil de lavar y desinfectar.

- Cinq doigts avec une sangle de poignet.
- Réversible pour la main droite à gauche.
- Conception de ceinture extractible et protection des mains complètes.
- Facile à laver et à désinfecter.

- Five fingers with a wrist strap.
- Reversible for right hand as left.
- Extractable belt design and full hand protection.
- Easy to wash and disinfect.

**Ideal para uso en mandolinas profesionales**  
Ideal for use in professional mandolins



UNE EN 1082  
EN ISO 13998: 2003  
NIVEL / LEVEL: 2

- Ajustable gracias a sus tirantes verticales y horizontales.
- Conviene asegurarse de que las medidas del cuchillo empleado no sean inferiores a: 20x12,5mm

- Réglable grâce à ses accolades verticales et horizontales.
- Il convient de s'assurer que les mesures du couteau utilisées ne sont pas inférieures à: 20x12,5 mm

- Adjustable thanks to its vertical and horizontal braces.
- It should be ensured that the measures of the knife used are not less than: 20x12.5mm

# Colección Etern

INOX PP  
Polypropylene BPA free

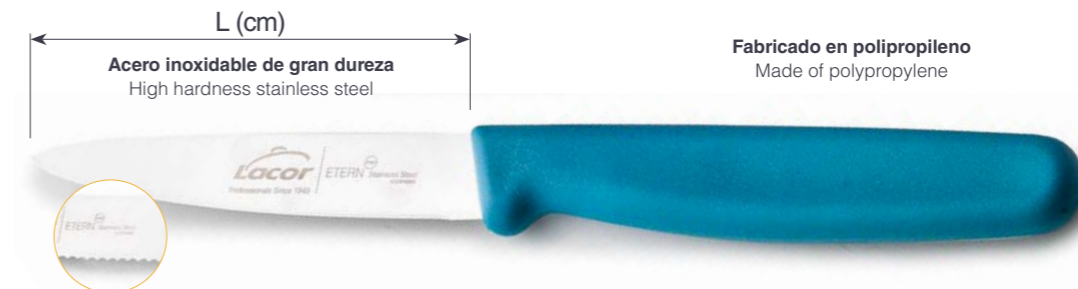

Filo liso o dentado  
Plain or serrated edge

Filo estrecho y delgado.  
Precisión en el corte  
Thin cutting edge for precise cutting

Se adapta a la mano cómodamente  
Ergonómico y antideslizante  
Handle for excellent grip during use



## Etern Ocean

	Ref	€	Largo (cm)	U.Venta
A	39220	3,40	9,0	1
	39223	3,50	10,0	1
B	39221	3,40	9,0	1
	39224	3,50	10,0	1
C	39226	3,50	10,5	1
D	39227	3,50	11,0	1

Cuchillo liso · Plain knife

Cuchillo dentado · Serrated knife

Cuchillo mesa · Table knife

Cuchillo chuletero · Steak knife



## Pelador universal

Éplucheur Universel · Universal-Schälmesser  
Universal peeler · Descascador Universal

	Ref	€	cm	Largo (cm)	U.Venta
A	39088	5,90	1x5	17	1
B	39089	5,90	1x5	17	1
C	39090	5,90	1x5	17	1

## Etern Magenta

	Ref	€	Largo (cm)	U.Venta
A	39230	3,40	9,0	1
	39233	3,50	10,0	1
B	39231	3,40	9,0	1
	39234	3,50	10,0	1
C	39236	3,50	10,5	1
D	39237	3,50	11,0	1

Cuchillo liso · Plain knife

Cuchillo dentado · Serrated knife

Cuchillo mesa · Table knife

Cuchillo chuletero · Steak knife



## Pelador Fast

Éplucheur · Schälmesser  
Peeler · Descascador

	Ref	€	cm	Largo (cm)	U.Venta
A	39091	5,90	4,5x1	11	1
B	39092	5,90	4,5x1	11	1
C	39093	5,90	4,5x1	11	1



# Colección Select

new

INOX TPV  
Plastic

- El color del mango identifica al cuchillo y garantiza un control higiénico-sanitario tal como especifican las normas europeas sanitarias de control alimentario.
- Hoja fabricada en acero inoxidable de máxima dureza y durabilidad, gracias a un correcto tratamiento térmico.
- Su forma convexa en ambas caras ofrece un filo muy afilado para un corte firme y equilibrado.
- Mango ergonómico y antideslizante fabricado en TPV. Ofrece una gran resistencia, adherencia y confort.

- La couleur du manche identifie le couteau et garantit un contrôle hygiénique et sanitaire conformément aux normes européennes de sécurité alimentaire.
- La lame est fabriquée en acier inoxydable d'une dureté et d'une durabilité maximales, grâce à un traitement thermique approprié.
- Sa forme convexe des deux côtés offre un bord très tranchant pour une coupe ferme et équilibrée.
- Manche ergonomique et antidérapant en TPV. Il offre une grande résistance, une bonne prise en main et un grand confort.

- The colour of the handle identifies the knife and guarantees a hygienic-sanitary control as specified by the European food safety standards.
- The blade is made of stainless steel of maximum hardness and durability, thanks to a correct heat treatment.
- Its convex shape on both sides offers a very sharp edge for a firm and balanced cut.
- Ergonomic, non-slip handle made of TPV. It offers great resistance, grip and comfort.



**Carnes rojas**  
Red meat



**Pescados y mariscos**  
Fish and seafood



**Carnes blancas y aves**  
White meat and poultry



**Verduras y frutas**  
Vegetables and fruits



**Embutidos y fiambres**  
Sausages and cold meats



**Pastelería y lácteos**  
Patisserie and dairy



**Alimentos sin alérgenos**  
Food allergen-free

Hoja fabricada en acero inoxidable de máxima dureza y durabilidad

HBlade made of stainless steel for maximum hardness and durability



Su forma convexa en ambas caras ofrecen un filo muy afilado para un corte firme y equilibrado

The convex shape on both sides provides a very sharp edge for a firm and balanced cut

Mango ergonómico y antideslizante fabricado en TPV.

Ergonomic, non-slip handle made of TPV



Ref	€	cm	U.Venta	
A 38301	16,20	20,0	1	Cuchillo Chef · Chef Knife
B 38311	17,50	25,0	1	Cuchillo cocina · Kitchen Knife
C 38330	15,10	17,5	1	Cuchillo carnicero · Butcher Knife
D 38340	11,50	12,5	1	Cuchillo deshuesador · Boning knife



Ref	€	cm	U.Venta	
A 38303	16,20	20,0	1	Cuchillo Chef · Chef Knife
B 38313	17,50	25,0	1	Cuchillo cocina · Kitchen Knife
C 38322	16,20	30,5	1	Cuchillo jamón · Ham knife
D 38342	11,50	12,5	1	Cuchillo deshuesador · Boning knife
E 38361	6,00	10,0	1	Cuchillo pelador · Peeling knife
F 38371	8,50	15,0	1	Cuchillo multiusos · Multi-purpose knife



Ref	€	cm	U.Venta	
A 38302	16,20	20,0	1	Cuchillo Chef · Chef Knife
B 38312	17,50	25,0	1	Cuchillo cocina · Kitchen Knife
C 38331	15,10	17,5	1	Cuchillo carnicero · Butcher knife
D 38341	11,50	12,5	1	Cuchillo deshuesador · Boning knife
E 38360	6,00	10,0	1	Cuchillo pelador · Peeling knife
F 38370	8,50	15	1	Cuchillo multiusos · Multi-purpose knife



Ref	€	cm	U.Venta	
A 38304	16,20	20,0	1	Cuchillo Chef · Chef Knife
B 38315	17,50	25,0	1	Cuchillo cocina · Kitchen Knife
C 38350	5,60	9,0	1	Cuchillo pelador · Peeling knife
D 38362	6,00	10,0	1	
D 38380	8,50	15,0	1	Cuchillo multiusos · Multi-purpose knife



Ref	€	cm	U.Venta	
A 38300	16,20	20,0	1	Cuchillo Chef · Chef Knife
B 38310	17,50	25,0	1	Cuchillo cocina · Kitchen Knife
C 38321	16,20	30,5	1	Cuchillo jamón · Ham knife
D 38391	17,70	30,5	1	Cuchillo asado · Roast knife



Ref	€	cm	U.Venta	
A 38305	16,20	20,0	1	Cuchillo Chef · Chef Knife
B 38316	17,50	25,0	1	Cuchillo cocina · Kitchen Knife
C 38332	15,10	17,5	1	Cuchillo carnicero · Butcher knife
D 38363	6,00	10,0	1	Cuchillo pelador · Peeling knife
E 38381	8,50	15,0	1	Cuchillo multiusos · Multi-purpose knife



Ref	€	cm	U.Venta	
A 38314	17,50	25,0	1	Cuchillo cocina · Kitchen Knife
B 38390	14,70	25,0	1	Cuchillo pan · Bread knife

# Colección Elite

## INOX

- Fabricados en acero inoxidable de alta calidad con una composición de 5Cr15 y una dureza 55±2.
- Hojas muy afiladas y resistentes al desgaste. Filos acabados en taper grinding.
- Mangos ergonómicos y antideslizantes en ABS con acero inoxidable, proporcionan un excelente agarre durante el uso.
- Ideales tanto para uso doméstico como profesional.
- Diseñados para el corte y manipulación de cualquier tipo de carne, pescado, verdura, fruta, patatas, etc.

- Fabriqué en acier inoxydable de grande qualité avec une composition de 5Cr15 et une dureté de 55±2.
- Lame très aiguisée et résistante à l'usure. Fil finition « taper grinding ».
- Manche ergonomique et antidérapant en ABS avec acier inoxydable, qui confère une excellente prise en main pendant l'utilisation.
- Idéal aussi bien pour un usage domestique que professionnel.
- Conçu pour couper et manipuler tout type de viandes, poissons, légumes, fruits, pommes de terre, etc.

- Made of high quality stainless steel with a composition of 5Cr15 and hardness of 55±2.
- Extremely sharp and wear resistant edge Taper ground edge.
- The ABS ergonomic non-slip handle with stainless steel provides an excellent grip during use.
- Perfect for home or professional use.
- Designed for cutting and manipulating any kind of meat, fish, vegetables, fruit or potatoes, etc.



### Cuchillo pelador

Couteau éplucheuse · Schäler Messer  
Peeler knife · Faca descascador

Ref	€	cm	U.Venta
38225	10,00	9,0	1



### Cuchillo cocina

Couteau de cuisine · Küchenmesser  
Kitchen knife · Faca cozinha

Ref	€	cm	U.Venta
38224	10,10	12,5	1



### Cuchillo Santoku

Couteau Santoku · Messer Santoku  
Santoku knife · Faca Santoku

Ref	€	cm	U.Venta
38223	16,30	18,0	1



### Cuchillo fileteador

Couteau filet-de-sole · Filiermesser  
Filetting/fish knife · Faca peixe / filetes

Ref	€	cm	U.Venta
38221	14,90	20,0	1



### Cuchillo pan

Couteau à pain · Brotmesser  
Bread knife · Faca de pão

Ref	€	cm	U.Venta
38222	14,90	20,0	1



### Cuchillo Chef

Couteau Chef · Messer Chef  
Chef knife · Faca Chef

Ref	€	cm	U.Venta
38220	16,10	20,0	1

# Colección Master

## INOX

- Fabricados en acero inoxidable de alta calidad con una composición de 5Cr15 y una dureza 55±2.
- Hojas muy afiladas y resistentes al desgaste. Filos acabados en taper grinding.
- Mangos ergonómicos y antideslizantes en ABS con acero inoxidable, proporcionan un excelente agarre durante el uso.
- Ideales tanto para uso doméstico como profesional.
- Diseñados para el corte y manipulación de cualquier tipo de carne, pescado, verdura, fruta, patatas, etc.

- Fabriqué en acier inoxydable de grande qualité avec une composition de 5Cr15 et une dureté de 55±2.
- Lame très aiguisée et résistante à l'usure. Fil finition « taper grinding ».
- Manche ergonomique et antidérapant en ABS avec acier inoxydable, qui confère une excellente prise en main pendant l'utilisation.
- Idéal aussi bien pour un usage domestique que professionnel.
- Conçu pour couper et manipuler tout type de viandes, poissons, légumes, fruits, pommes de terre, etc.

- Made of high quality stainless steel with a composition of 5Cr15 and hardness of 55±2.
- Extremely sharp and wear resistant edge Taper ground edge.
- The ABS ergonomic non-slip handle with stainless steel provides an excellent grip during use.
- Perfect for home or professional use.
- Designed for cutting and manipulating any kind of meat, fish, vegetables, fruit or potatoes, etc.



### Cuchillo pelador

Couteau éplucheuse · Schäler Messer  
Peeler knife · Faca descascador

Ref	€	cm	U.Venta
38235	6,40	9,0	1



### Cuchillo cocina

Couteau de cuisine · Küchenmesser  
Kitchen knife · Faca cozinha

Ref	€	cm	U.Venta
38234	6,50	12,5	1



### Cuchillo Santoku

Couteau Santoku · Messer Santoku  
Santoku knife · Faca Santoku

Ref	€	cm	U.Venta
38233	10,90	18,0	1



### Cuchillo fileteador

Couteau filet-de-sole · Filiermesser  
Filetting/fish knife · Faca peixe / filetes

Ref	€	cm	U.Venta
38231	9,60	20,0	1



### Cuchillo pan

Couteau à pain · Brotmesser  
Bread knife · Faca de pão

Ref	€	cm	U.Venta
38232	9,60	20,0	1



### Cuchillo Chef

Couteau Chef · Messer Chef  
Chef knife · Faca Chef

Ref	€	cm	U.Venta
38220	16,10	20,0	1

# Colección Classic



Dishwasher

- Cuchillos forjados realizados en una sola pieza.
- Fabricados en acero inoxidable X 45 Cr Mo V 15. Dureza de 54-58 HRC.
- Mango ergonómico.
- Remaches resistentes a la corrosión.
- Cuchillo estable, fuerte y de gran durabilidad.

- Couteaux forgés réalisés en une seule pièce.
- Fabriqués en acier inoxydable X 45 Cr Mo V 15. Dureté 54-58 Hc.
- Manche ergonomique.
- Rivets résistants à la corrosion.
- Couteau stable, solide et d'une grande durabilité.

**54-58 MOLYBDÄNSTAHL** Cuchillo forjado

HRC X 45 Cr Mo V 15 Forged knives

Acero inoxidable al cromo-molibdeno-vanadio  
Chrome-molybdenum-vanadium stainless steel

- One-piece forged knives.
- Made with X 45 Cr Mo V 15 stainless steel. 54-58 Hc hardness.
- Ergonomic handle.
- Corrosion resistant rivets.
- A stable, strong and extremely durable knife.



## Cuchillo Chef

Couteau de cuisine · Messer Chef  
Cook's knife · Faca Chef

Ref	€	cm	U.Venta
39016	20,60	16	1
39021	25,50	21	1
39025	29,00	25	1
39030	37,20	30	1



## Cuchillo cocina

Couteau de cuisine · Küchenmesser  
Kitchen knife · Faca cozinha

Ref	€	cm	U.Venta
39110	10,60	10	1
39112	12,00	12	1
39114	13,60	14	1
39116	16,40	16	1
39118	18,40	18	1
39121	19,20	21	1
39125	20,60	25	1



## Cuchillo pescado / fileteador

Couteau filet-de-sole · Filiermesser  
Filleting/fish knife · Faca peixe / filetes

Ref	€	cm	U.Venta
39115	13,60	20	1



## Cuchillo deshuesador

Couteau à désosser · Ausbeinmesser  
Boning knife · Faca desossador

Ref	€	cm	U.Venta
39014	16,40	14	1



## Cuchillo patatero

Couteau office · Gemüsemesser  
Paring knife · Faca batatas

Ref	€	cm	U.Venta
39185	11,20	8,50	1



## Cuchillo jamonero

Couteau à jambon · Schinkenmesser  
Ham knife · Faca de presunto

Ref	€	cm	U.Venta
39020	21,40	21	1
39024	24,00	26	1



## Cuchillo pan

Couteau à pain · Brotmesser  
Bread knife · Faca de pão

Ref	€	cm	U.Venta
39027	19,30	21	1



## Cuchillo congelados

Couteau aliments surgelés · Gefrierwarenmesser  
Frozen food knife · Faca congelados

Ref	€	cm	U.Venta
39028	20,10	21	1



## Tenedor de trinchar

Fourchette de chef · Tranchiergabel  
Cook's fork · Garfo de trinchar

Ref	€	cm	U.Venta
39017	17,20	18	1



## Machete

Couperet · Hackfleischmesser  
Cleaver · Cutelo

Ref	€	cm	U.Venta
39015	59,00	16	1



## Macheta

Couperet · Hackfleischmesser  
Cleaver · Cutelo

Ref	€	cm	U.Venta
39018	21,90	17x8	1



## Macheta para pescado

Couperet à poisson · Sehr Scharfes fischmesser  
Fish cleaver · Cutelo para peixe

Ref	€	cm	U.Venta
39029	22,60	29	1



## Chaira

Fusil à affûter · Wetzstahl  
Sharpening steel · Fusil

Ref	€	Largo (cm)	U.Venta
39010	21,60	21	1

## Taco 5 cuchillos Chef

5 couteau de Bloc · 5 Messer Set  
5 knife block · Taco 5 facas

Ref	€	Largo (cm)	U.Venta
39064	66,80	20	1



### COMPOSICIÓN (6 pcs.):

- \* Cuchillo Chef 21 cm (39021)
- \* Cuchillo de cocina de 10 cm (39110)
- \* Cuchillo de cocina de 16 cm (39116)
- \* Cuchillo deshuesador 14 cm (39014)
- \* Cuchillo jamonero 20 cm (39020)
- \* Chaira (39010)

### COMPOSICIÓN (8 pcs.):

- \* Cuchillo Chef 21 cm (39021)
- \* Cuchillo de cocina de 10 cm (39110)
- \* Cuchillo de cocina de 16 cm (39116)
- \* Cuchillo deshuesador 14 cm (39014)
- \* Cuchillo jamonero 20 cm (39020)
- \* Cuchillo pan (39027)
- \* Tenedor trinchar (39017)
- \* Chaira (39010)



## Taco 6/8 piezas

6/8 pcs bloc · Messerhalter Set, 6/8-tlg  
6/8 pc bloc · Taco 6/8 peças

Ref	€	Piezas	U.Venta
39000	135,10	6	1
39001	165,30	8	1



## Maleta 9 piezas

9 pcs mallette de chef · Messertasche, 9-tlg  
9 pc cook's case · Mala 9 peças

Ref	€	U.Venta
39004	357,10	1

### COMPOSICIÓN:

- \* Cuchillo de cocina de 10 cm (39110)
- \* Cuchillo de cocina de 18 cm (39118)
- \* Cuchillo de cocina de 25 cm (39125)
- \* Cuchillo deshuesador 14 cm (39014)
- \* Cuchillo jamonero 20 cm (39020)
- \* Cuchillo Chef 25 cm (39025)
- \* Tenedor trinchar (39017)
- \* Macheta (39015)
- \* Chaira (39010)

# Colección Profesional

INOX   
Dishwasher

- Cuchillo estampado.
- Fabricado en acero inoxidable al cromo-molibdeno-vanadio X 45 Cr Mo V 15. Dureza de 54-58 HRc.
- Cuchillo estable, fuerte y de gran durabilidad.
- Mango ergonómico antideslizante, tacto suave Soft Touch.

- Couteau estampé.
- Fabriqué en acier inoxydable au chrome-molybdène -vanadium X 45 Cr Mo V 15. Dureté de 54-58 HRc.
- Couteau stable, robuste et d'une grande durabilité.
- Manche ergonomique antidérapant, toucher doux Soft Touch.

54-58 MOLYBDÄNSTAHL Mango Antideslizante  
HRc X 45 Cr Mo V 15 Non-slip long handle knives  
Acero inoxidable al cromo-molibdeno-vanadio  
Chrome-molybdenum-vanadium stainless steel

- Stamped Knife.
- Made of X 45 Cr Mo V 15 chromium-vanadium stainless steel. 54-58 HRc Hardness.
- A stable, strong and durable knife.
- Non-slip ergonomic handle, smooth Soft Touch feel.



**Cuchillo Chef**  
Couteau de chef · Messer Chef  
Cook's knife · Faca Chef

Ref	€	cm	U.Venta
49016	7,10	16	12
49021	10,50	21	12
49025	12,30	25	12
49030	13,40	30	12



**Cuchillo cocina**  
Couteau de cuisine · Küchenmesser  
Kitchen knife · Faca cozinha

Ref	€	cm	U.Venta
49110	4,90	10	12
49112	4,90	12	12
49116	5,70	16	12
49121	7,40	21	12



**Cuchillo patatero**  
Couteau office · Gemüsemesser  
Paring knife · Faca batatas

Ref	€	cm	U.Venta
49185	4,40	8,50	12



**Cuchillo deshuesador**  
Couteau à désosser · Ausbeinmesser  
Boning knife · Faca desossador

Ref	€	cm	U.Venta
49014	5,40	14	12



**Cuchillo jamonero**  
Couteau à jambon · Schinkenmesser  
Ham knife · Faca de presunto

Ref	€	cm	U.Venta
49024	8,40	26	12



**Cuchillo pan**  
Couteau à pain · Brotmesser  
Bread knife · Faca de pão

Ref	€	cm	U.Venta
49027	7,60	21	12



**Tenedor para trinchar**  
Fourchette de chef · Tranchiergabel  
Cook's fork · Garfo de trinchar

Ref	€	cm	U.Venta
49017	6,60	18	12



**Cuchillo Santoku**  
Couteau Santoku · Messer Santoku  
Santoku knife · Faca Santoku

Ref	€	cm	U.Venta
49210	6,60	10	12
49212	8,00	12	12
49216	11,00	16	12

# Colección Ceramic

CE   
Ceramic Dishwasher

- Mango ergonómico antideslizante con un diseño moderno e innovador.
- Resistente, ligero e higiénico.
- NO oxida los alimentos.
- El filo se mantiene hasta diez veces más que los cuchillos convencionales.

- Mangue ergonomique non glissante avec un design moderne et innovant.
- Résistant, léger et hygiénique.
- Ne pas oxyder les aliments.
- Le bord reste jusqu'à dix fois plus que les couteaux conventionnels.

- Ergonomic non-slip mango with a modern and innovative design.
- Resistant, light and hygienic.
- Do not oxidize food.
- The edge remains up to ten times more than conventional knives.



**Cuchillo cocina**  
Couteau de cuisine · Küchenmesser  
Kitchen knife · Faca cozinha

	Ref	€	cm	U.Venta
A	39208	11,00	8	1
B	39210	12,00	10	1
C	39212	20,30	12	1
D	39215	26,40	15	1
E	39218	39,10	18	1
F	39213	24,40	12	1

**Chiara Diamante**  
Fusil à affûter · Wetzstahl  
Sharpening steel · Fusil

Ref	€	cm	U.Venta
39075	36,60	21	1



# Cuchillos Mesa

INOX  
Dishwasher

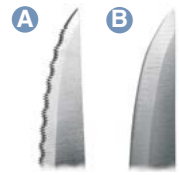

- Set de 6 cuchillos chuleteros microdentados fabricados en acero inoxidable de gran calidad.
- Gran resistencia y durabilidad, ideal para el uso diario.
- Diseñado especialmente para cortar todo tipo de carnes.
- Mango ergonómico de madera de gran resistencia y durabilidad con líneas redondeadas que ofrecen un agarre cómodo y seguro. Medidas: 21,5 cm de longitud y tamaño de la hoja: 10,5 cm.

- Set of 6 micro serrated steak knives made of high quality stainless steel
- Extremely strong and durable, perfect for daily use specially designed for cutting all kinds of meat.
- It has an extremely strong and durable ergonomic wooden handle with curved lines that give a comfortable and safe grip. Measurements: 21.5 cm long and blade size: 10.5 cm

6 pcs

**Set de cuchillos chuleteros Wood**  
6 couteau steak · 6 steakmesser,  
6 pcs steak knives · Conjunto 6 facas carne

Ref	€	cm	U.Venta
38240	15,70	10,5	1

**Set de 6 cuchillos chuleteros**  
6 couteau steak · 6 steakmesser,  
6 pcs steak knives · Conjunto 6 facas carne

Ref	€	Largo (cm)	U.Venta
A 39060	15,80	21	12
B 39061	15,10	21	12

# Colección cortaquesos

Dishwasher

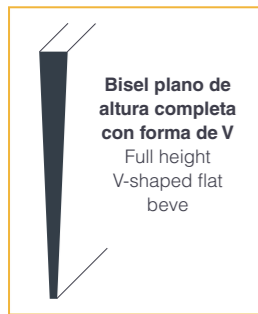

## Taper Grinding

Reducción uniforme de la hoja desde el lomo consiguiendo un filo fuerte y duradero.  
Gradually reduction width from the spine resulting in a strong and durable cutting edge.



**Cuchillo cortaquesos Classic**  
Couteau à fromage · Käseschneidmesser  
Cheese slicing knife · Faca para cortar queijo

Ref	€	cm	U.Venta
39100	46,40	30	1



**Cuchillo cortaquesos Profesional**  
Couteau à fromage · Käseschneidmesser  
Cheese slicing knife · Faca para cortar queijo

Ref	€	cm	U.Venta
39101	42,60	40	1

new

- Set de 6 cuchillos microdentados fabricados de una sola pieza en acero inoxidable de gran calidad.
- Cuentan con un filo de sierra y punta afilada, ideal para cortar todo tipo de alimentos sin ninguna dificultad.
- Gran resistencia y durabilidad, perfecto para el uso diario. Mango ergonómico que ofrece un agarre cómodo y seguro.
- Medidas: 22 cm de longitud. Tamaño de la hoja: 11 cm.

- Set of 6 micro serrated knives made in one piece of high quality stainless steel.
- It has a serrated edge and sharp point, ideal for cutting all types of food without any difficulty.
- Extremely strong and durable, perfect for daily use. Ergonomic handle that give a comfortable and safe grip.
- Measurements: 22 cm long. Blade size: 11 cm.

A Dentado · Serrated



B Liso · Plain



6 pcs

**Set de cuchillos Monoblock**  
Ensemble de couteaux · Satz Messer  
knife set · Conjunto de facas

Ref	€	cm	U.Venta
A 38241	22,40	22	1
B 38242	22,40	22	1

Acero inoxidable 54-58

X 50 Cr Mo V 15 HRc

Acero inoxidable al cromo-molibdeno-vanadio  
Chrome-molybdenum-vanadium stainless steel

# Tijeras

INOX  
Dishwasher



## Tijeras para aves Black

Ciseaux à volaille · Geflügelschere  
Poultry shears · Tesouras para aves

Ref	€	cm	U.Venta
60001	19,30	7,5x27	12

## Protector y cepillo de limpieza

Protector and cleaning brush



## Tijeras 5 cortes

Ciseaux 5 coupe · 5-fach Schneideschere  
5 Cuts vegetable scissor · Tesouras 5 cortes

Ref	€	cm	U.Venta
60022	8,70	27x13x3	6

- 1.- Tijeras · Scissors
- 2.- Abrebotellas · Unscrew
- 3.- Cascanueces · Nut cracker

1

2

3



## Tijeras profesionales Inox

Ciseaux profesional · Geflügelschere Profesional  
Professional scissors · Tesouras professional

Ref	€	cm	U.Venta
38010	22,40	7,0x20	12



## Tijera desescamador

Ciseaux ecailleur · Schere-Fischentschupper  
Scissors-scrapper · Tesoura-raspador

Ref	€	Largo (cm)	U.Venta
60061	6,10	23	1

Ambidiestro  
Ambidextrous



FO

Forjado  
Wought



## Tijeras para aves Inox

Ciseaux à volaille · Geflügelschere  
Poultry shears · Tesouras para aves

Ref	€	Largo (cm)	U.Venta
60066	36,20	25	1

## Soporte magnético

Magnetic holder



## Tijeras de cocina Magnetic

Ciseaux pour cuisine · Küchenschere  
Kitchen shears · Tesouras de cozinha

Ref	€	Largo (cm)	U.Venta
60059	10,30	21,5	6



## Tijera de cocina Grey

Ciseaux pour cuisine · Küchenschere  
Kitchen shears · Tesouras de cozinha

Ref	€	cm	U.Venta
60018	11,00	8,5x21	1
60023	11,10	8,5x24	1

# Abrelatas



Dishwasher



Altura máx. de lata: 30 cm - Maxime height of caniste: 30 cm

## Abrelatas de mesa profesional

Ouvre-boîte de table professionnel · Profe-Dosenöffner für Tisch  
Professional table tin opener · Abre-latas de mesa profesional

Ref	€	U.Venta
63005	131,70	1
63015	194,20	1



## Abrelatas

Ouvre-boîte · Dosenöffner  
Can opener · Abre-latas

Ref	€	cm	Largo (cm)	U.Venta
62689	27,20	5x4	20	6

# Tacos para cuchillos



Dishwasher



BPA free

- Bloques cilíndricos fabricados en polipropileno con recubrimiento TPR y acabado en color blanco mate (39037) / metalizado (39038).
- Diseñados para almacenar cuchillos de filo liso, filo dentado y tijeras.
- Aptos para cuchillos de hasta 20 cm (39037) / 21 cm (39038) de longitud de hoja.
- Varillas interiores de fibras de polipropileno (39037).
- Las ranuras separan los bordes de los filos sin tocarse ni rayarse entre sí (39038).
- Desmontables para facilitar la limpieza.

- Bloc cylindrique fabriqué en polypropylène avec un revêtement TPR et une finition blanc mat (39037) / métallisé (39038).
- Conçu pour ranger des couteaux à fil lisse, à fil denté et des ciseaux.
- Compatibles avec des couteaux jusqu'à 20 cm (39037) / 21 cm (39038) de longueur de lame.
- Tiges intérieures en fibre de polypropylène (39037).
- Les rainures séparent les bords des fils, évitant ainsi qu'il se touchent ou se rayent entre eux (39038).
- Démontables pour faciliter le nettoyage.

- Cylindrical polypropylene knife holder with TPR coating and matte white finish (39037) / metallised (39038).
- Designed to hold smooth-edged knives, serrated knives and scissors.
- Suitable for knives with blade lengths up to 20 cm (39037) / 21 cm (39038).
- Inner polypropylene fibre rods. (39037).
- The slots separate the edges of the blades and prevent them from touching or scratching each other (39038).
- Removable for easy cleaning.



Varillas de fibras  
Fibre rods



## Tacos de cuchillos White

Bloc à couteaux · Messerblock  
Knife block · Taco para facas

Ref	€	Ø (cm)	h (cm)	U.Venta
39037	14,90	11	22,0	1



Ranuras separadoras  
Slots separators



## Tacos para cuchillos TitanPro

Bloc à couteaux · Messerblock  
Knife block · Taco para facas

Ref	€	Ø (cm)	h (cm)	U.Venta
39038	14,00	13	22,8	1

# Soporte para cuchillos



Dishwasher



- Potente imán en el interior para sujetar con seguridad los cuchillos, tijeras y otros artículos metálicos.
- Incluye un set de montaje para instalar el soporte de cuchillos sobre cualquier tipo de pared.

- Aimant puissant à l'intérieur pour tenir des couteaux, des ciseaux et d'autres objets métalliques en toute sécurité.
- Comprend un ensemble de montage pour installer la prise en charge des couteaux sur tout type de mur.

- Powerful magnet inside to safely hold knives, scissors and other metal items.
- Includes a mounting set to install knives support on any type of wall.

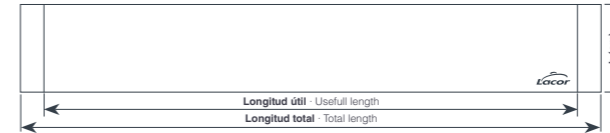

RUBBER  
WOOD

## Soporte magnético cuchillos Wood

Support magnétique pour couteaux · Magnethalterung für Messer  
Magnet support for knives · Suporte magnético de facas

Ref	€	cm	h (cm)	Útil (cm)	U.Venta
39108	27,80	36	6	33	1
39109	32,60	45	6	45	1



Potente imán  
Powerful magnet

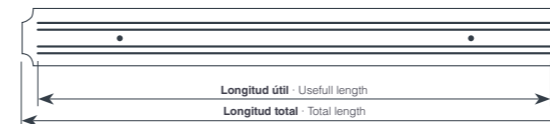

## Soporte magnético cuchillos Black

Support magnétique pour couteaux · Magnethalterung für Messer  
Magnet support for knives · Suporte magnético de facas

Ref	€	cm	Útil (cm)	U.Venta
39008	9,10	38	35,0	12
39009	11,10	55	52,3	12



Potente imán  
Powerful magnet



HAYA  
Wood

## Bloque magnético Magnet

Bloc magnétique · Magnetblock  
Magnetic block · Bloco magnético

Ref	€	cm	U.Venta
39039	27,60	21x22,5	1



- Bloque de madera de haya 100% natural con un potente imán integrado.
- Ideal para colocar cuchillos, tijeras o utensilios metálicos.
- Espacio para 5 cuchillos de cocina de diferentes tamaños.
- Diseño 100% estable: bloque firme y sólido.
- Ideal para mantener en buen estado los filos de los cuchillos y tenerlos siempre a mano.

- Support en hêtre 100% naturel avec un puissant aimant intégré.
- Idéal pour ranger les couteaux, les ciseaux ou les ustensiles métalliques.
- Espace pour 5 couteaux de cuisine de différentes tailles.
- Conception 100% stable : bloc fixe et solide.
- Idéal pour conserver en bon état les fils des couteaux et les avoir toujours à portée de main.

- 100% natural beech wood block with a powerful built-in magnet
- Ideal for holding knives, scissors or metal utensils.
- Space for up to 5 kitchen knives of different sizes.
- 100% Stable Design: the block is solid and sturdy.
- It's perfect for having the knives always handy and keeping their blades in good condition.

# Afiladores cuchillos



Dishwasher

- **Dos fases de afilado: primera fase para un afilado grueso, para cuchillos más deteriorados. Segunda fase para el pulido final o afilado diario.**
- **Ángulo de afilado regulable: garantiza un filo renovado y efectivo.**
- **100% preciso y seguro. Base antideslizante.**

- Two sharpening phases: first phase for coarse sharpening of blunt blades. Second phase for final honing or daily sharpening.
- Adjustable sharpening angle: guarantees a renewed, much sharper edge.
- 100% precise and safe. Non-slip base.



**Primera fase**  
**Afilado grueso**  
First phase  
Coarse sharpening



**Segunda fase**  
**Pulido final o afilado diario**  
Second phase  
Final honing or daily sharpening

## Afilador de cuchillos vertical

Affûteuse de couteaux · Schärmaschine  
Knives sharpener · Afiador de facas



Ref	€	cm	h(cm)	U.Venta
39263	10,90	9,5x5,5	9,5	1

- **Afila cuchillos de filo liso.**
- **2 zonas de afilado: afilado estándar y afilado alta precisión.**
- **Cada zona consta de: 2 discos de acero de carburo duro (grueso) para vaciar bordes y 2 discos de cerámica fina para terminar el borde.**

- Shark smooth edge knives.
- 2 Sharpening areas: Standard and sharp sharpening high precision.
- Each area consists of: 2 hard carbide (thick) steel discs to empty edges and 2 fine ceramic discs to finish the edge.



**Base antideslizante**  
Non-slip base  
**Orientación de afilado**  
Sharpening orientation



## Afilador de cuchillos Dual

Affûteuse de couteaux · Schärmaschine  
Knives sharpener · Afiador de facas

Ref	€	cm	U.Venta
39266	19,20	21,5x4,5x9	1

- **Dos ranuras de afilado:**  
1.- **Ranura de carburo de tungsteno: afilado grueso para las hojas más deterioradas.**  
2.- **Ranura cerámica: pulido final o afilado diario.**
- **Dos posiciones de afilado:**  
1.- **Posición en superficie plana: para cuchillos pequeños con hojas rectas.**  
2.- **Posición en borde o esquina: para cuchillos grandes o con hojas curvadas.**
- **Afilado óptimo en pocas pasadas.**

- 2 sharpening slots:  
1.- tungsten carbide slot: coarse sharpening of blunt blades.  
2.- Ceramic slot: final honing or daily sharpening.
- 2 sharpening positions:  
1.- Position on flat surface: for small knives with straight blades.  
2.- Edge or corner position: for knives large or curved blades.
- Optimum sharpening in just a few strokes.

## Afilador de cuchillos Mini

Affûteuse de couteaux · Schärmaschine  
Knives sharpener · Afiador de facas



Ref	€	cm	h(cm)	U.Venta
39264	7,60	10x5,2	4,5	1

- **Afilador de precisión, diseñado para alargar la vida útil de los cuchillos y tijeras.**
- **Versátil: 6 modos de afilado: afilado grueso, medio, fino, tijeras, cuchillos para sushi y cuchillos de pan.**
- **Fácil de usar: gire la perilla a la posición adecuada para el tipo de cuchillo a afilar.**
- **Ranura de afilado de carburo de tungsteno y cerámica, remodela el ángulo, afila uniformemente y rejuvenece el lo para una mejor calidad y durabilidad.**
- **Mango ergonómico y base antideslizante para mayor estabilidad y seguridad.**
- **Resistente y duradero. Ambidiestro.**

- High precision sharpener, specially designed to extend the life of knives and scissors.
- Fully versatile with 6 sharpening modes: coarse, medium, fine, scissors, sushi knives and bread knives.
- Easy to use: turn the knob to the appropriate position for the type of knife to be sharpened.
- Tungsten carbide and ceramic sharpening groove that reshapes, evenly sharpens and renews the cutting edge for better quality and longer life.
- Ergonomic handle and non-slip base for stability and safety.
- Robust and durable. Ambidextrous.



**ABS**  
Plastic  
**CE**  
Ceramic  
**Carburo Tungsten**  
carbide



## Afilador de precisión 6 en 1

Affûteuse de précision · Präzisionsschärfer  
Precision sharpener · Afiador de precisão

Ref	€	cm	U.Venta
39262	12,90	8,5x4,3x9,4	1



## Afilador de cuchillos Eléctrico Rond

Affûteuse de couteaux électrique · Elektrische Schärmaschine  
Electric knife sharpener · Afiador de facas electrónico

Ref	€	W	Medidas	U.Venta
69141	33,00	60	14 x 14 x 10 cm	1



**Fase 1: Alta abrasividad** · high abrasiveness  
**Fase 2: Afilado fino** · thin sharp  
**Fase 3: Microafilado** · micro-sharp



## Afilador de cuchillos eléctrico Pro

Affûteuse de couteaux électrique · Elektrische Schärmaschine  
Electric knife sharpener · Afiador de facas electrónico

Ref	€	W	Medidas	U.Venta
69261	127,60	180	32 x 12 x 11 cm	1



**Cuchillos lisos** · Smooth knives  
**Rejilla salida viruta** · Chip outlet grid



## Afilador de cuchillos eléctrico Mouse

Affûteuse de couteaux électrique · Elektrische Schärmaschine  
Electric knife sharpener · Afiador de facas electrónico

Ref	€	W	Medidas	U.Venta
60359	50,40	180	16 x 10 x 7 cm	1

- **Dispone de diferentes ranuras para poder afilar distintos tipos de utensilios como cuchillos, tijeras o destornilladores de punta plana.**
- **El motor gira a la velocidad óptima para que el afilado de los utensilios sea preciso y duradero.**
- **100% seguro: en su base se incluyen cuatro ventosas de fijación para evitar que el afilador se mueva durante su uso.**

- It has different grooves to be able to sharpen different types of utensils such as knives, scissors or screwdrivers on the flat tip.
- The engine revolves at the optimal speed so that the sharpening of the utensils is precise and lasting.
- 100% safe: four fixing suction cups are included to prevent the sharpener from moving during use.



## Afilador de cuchillos eléctrico TitanPro

Affûteuse de couteaux électrique · Elektrische Schärmaschine  
Electric knife sharpener · Afiador de facas electrónico

Ref	€	W	Medidas	U.Venta
69341	40,20	60	17x8x10 cm	1

- **Afilador de cuchillos eléctrico fabricado con discos de material resistente y preparados para el uso intensivo.**
- **Diseñado para afilar cuchillos de acero inoxidable (lisos y dentados) y cuchillos de cerámica. Ángulo de afilado de 20°.**
- **Sistema basado en 3 etapas: grueso, fino y pulido.**
- **Eficiente y potente: equipado con un motor de 18 W de corriente continua y una rotación de alta velocidad de 2800 r.p.m.**
- **Rodillo con recubrimiento 100% de diamante en ranura gruesa (grano 360), abrasivos de diamante en ranura fina (grano 600) y resina de alta tecnología en ranura de pulido (grano 1000). Afilado rápido y seguro.**
- **Base magnética que recoge las partículas de material metálico desbastado.**
- **Base antideslizante: garantiza la estabilidad durante el uso.**

- Electric knife sharpener fitted with hard-wearing discs of resistant material and designed for heavy-duty use.
- Designed for sharpening stainless steel (smooth and serrated) and ceramic knives. 20-degree sharpening angle.
- 3-stage sharpening system: coarse, fine and polish.
- Efficient and powerful: equipped with an 18 W DC, 2800 RPM high speed motor.
- Roller with 100% diamond coating in the coarse slot (360 grit), diamond abrasives in the fine slot (600 grit) and high-tech resin in the polishing slot (1000 grit). Quick, safe sharpening.
- Magnetic base to collect metal shavings after the sharpening process.
- Non-slip base for optimum stability during use.



## Afilador de cuchillos Drei

Affûteuse de couteaux · Schärmaschine  
Knife sharpener · Afiador de facas

Ref	€	cm	h(cm)	W	Velocidad (r.p.m.)	U.Venta
69432	102,60	26,5x10,7	9,5	18	2800	1

# Tablas de corte



- Duradera, resistente, indeformable y antibacteriana.
- Las fibras de madera ayudan a mantener el filo de los cuchillos afilados durante más tiempo..
- GRIPsystem: pies singulares fabricados en silicona para utilizar las tablas en cualquier superficie sin riesgo de deslizamiento.
- El orificio es perfecto para colgar la tabla y facilitar su almacenaje. .

- Durable, résistant, indéformable et antibactérien.
- Les fibres en bois aident à garder le bord des couteaux tranchants plus longtemps.
- Gripsystem: pieds singuliers en silicone pour utiliser les tables sur n'importe quelle surface sans risque de glissement.
- Le trou est parfait pour accrocher la table et faciliter son stockage.

- Durable, resistant, undeformable and antibacterial.
- Wooden fibers help keep the edge of sharp knives for a longer time.
- GripSystem: Singular feet made of silicone to use the tables on any surface without sliding risk.
- The hole is perfect for hanging the table and facilitating its storage.



## Tabla de corte Black

Planche à découper · Schneidebrett  
Cutting board · Tábua de corte

Ref	€	cm	e (mm)	U.Venta
60580	18,70	30x21,5	6	1
60581	25,20	37x27,5	6	1
60582	35,70	44x32,5	6	1



## Tabla de corte Nogal

Planche à découper · Schneidebrett  
Cutting board · Tábua de corte

Ref	€	cm	e (mm)	U.Venta
60586	17,20	26,5x19,5	6	1
60587	21,70	30x23,5	6	1
60588	33,80	40x30	6	1



## Tabla de corte para pan GN 1/1

Planche à découper pain · Schneidebrett brot  
Bread cutting board · Tábua de corte pão

Ref	€	cm	h(cm)	U.Venta
60486	42,00	53x32,5	2	1



## Tabla de corte para pan

Planche à découper pain · Schneidebrett brot  
Bread cutting board · Tábua de corte pão

Ref	€	cm	h(cm)	U.Venta
60487	29,50	40x30	2	1



BAMBOO  
Dishwasher

## Tabla de corte pan Oval

Planche à découper pain ovale · Schneidebrett oval brot  
Oval bread cutting board · Tábua de corte pão oval

Ref	€	cm	h(cm)	U.Venta
60491	36,80	40x27	3	1



BAMBOO  
Dishwasher

## Tabla de corte Line

Planche à découper pain · Schneidebrett brot  
Bread cutting board · Tábua de corte pão

Ref	€	cm	h(cm)	U.Venta
60495	23,20	50x15	2	1



BAMBOO  
Dishwasher

## Set 3 tablas de corte

Set 3 planches à découper · Set 3 Schneidebrett  
3 cutting boards set · Conjunto 3 tábuas de corte

Ref	€	cm	U.Venta
60523	18,30	20x15	1
		28x22	
		33x25	



BAMBOO  
Dishwasher

## Tabla de corte Dual

Planche à découper · Schneidebrett  
Cutting board · Tábua de corte

Ref	€	cm	h(cm)	U.Venta
60492	37,60	39,5x38	4	1



RUBBER WOOD  
Dishwasher

## Tabla de corte Rubber Wood

Planche à découper · Schneidebrett  
Cutting board · Tábua de corte

Ref	€	cm	h(cm)	U.Venta
60485	70,30	53,3x32,8	4	1
60488	36,00	33x25	4	1



BAMBOO PP  
Polypropylene  
Dishwasher

## Tabla de corte Collect Home

Planche à découper · Schneidebrett  
Cutting board · Tábua de corte

Ref	€	Tabla (cm)	Cubeta	U.Venta
60594	30,60	35x29x4	-	1
R60594A	4,90	-	34x26,5x2	1



RUBBER WOOD INOX

## Tabla de corte Collect GN 2/3

Planche à découper · Schneidebrett  
Cutting board · Tábua de corte

Ref	€	Tabla (cm)	Cubeta	L	U.Venta
60592	72,90	41,5x34x7	-	-	1
* 66540Z	20,50	-	35,4x32,5x4	3,50	1

\* Apta cubeta inox 18/10 (66540) · Suitable for 18/10 stainless steel tray (66540)



RUBBER WOOD INOX

## Tabla de corte Collect 2xGN 1/2

Planche à découper · Schneidebrett  
Cutting board · Tábua de corte

Ref	€	Tabla (cm)	Cubeta	L	U.Venta
60591	102,20	61,5x34x7	-	-	1
* 66240Z	10,90	-	26,5x32,5x4	2,50	1

\* Apta cubeta inox 18/10 (66240) · Suitable for 18/10 stainless steel tray (66240)





BAMBOO  
Dishwasher

**Tabla de corte Collect**  
Planche à découper · Schneidebrett  
Cutting board · Tábua de corte

Ref	€	cm	h(cm)	U.Venta
60595	31,10	40x26	5	1

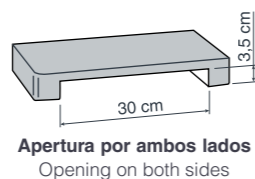

Apertura por ambos lados  
Opening on both sides

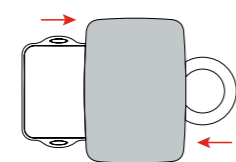

Ideal para colocar platos o bandejas en ambos lados  
Ideal for placing plates or trays on both sides

- Práctica tabla de corte con una cubeta de PP oculta completamente extraíble.
- Tabla de corte tratada con un revestimiento protector y antibacteriana.
- Cubeta extraíble para recoger los alimentos cortados.
- Pies antideslizantes; garantizan la estabilidad de la tabla durante el corte.

- Practical cutting table with a completely removable hidden PP bucket.
- Treated cutting table with a protective and antibacterial coating.
- Removable bucket to collect cut foods.
- Non -slip feet; They guarantee the stability of the table during cutting.



ACACIA  
Wood  
CRISTAL  
Glass  
Dishwasher



AS  
Plastic  
BPA free

**Set cuchillos para queso**

Jeu de couteaux pour le fromage · Set von Messern für Käse  
Knives set · Jogo de facas para queijo

Ref	€	Ø (cm)	h(cm)	U.Venta
60072	48,30	25	5	1



- Fabricadas en polipropileno de alta densidad y máxima resistencia.
- Superficie de corte de doble cara. Tres colores diferentes. Higiénicas y fáciles de limpiar.
- Práctico agujero para colgar y facilitar el almacenaje.
- Aptas para el lavavajillas.

- Manufactured in high density and maximum resistance polypropylene.
- Double -sided cutting surface. Three different colors. Hygienic and easy to clean.
- Practical hole to hang and facilitate storage.
- Suitable for dishwasher.



PP  
Polypropylene  
BPA free  
Dishwasher

**Set de tablas de corte Grey**  
Set 3 planches à découper · Set 3 Schneiderbrett  
3 cutting boards set · Conjunto 3 tábuas de corte

Ref	€	cm	U.Venta
60500	13,60	20x15	1
		30x20	
		35x25	



PP  
Polypropylene  
BPA free  
Dishwasher

**Set de tablas de corte Ocean**  
Set 3 planches à découper · Set 3 Schneiderbrett  
3 cutting boards set · Conjunto 3 tábuas de corte

Ref	€	cm	U.Venta
60555	13,60	20x15	1
		30x20	
		35x25	

Asa para facilitar su manejo  
Tope de silicona antideslizante  
Antibacteriana  
Handle for easy handling  
Non-slip silicone stopper  
Antibacterial

PP  
Polypropylene  
Dishwasher  
BPA free

**Tabla de corte Red**  
Planche à découper · Schneidebrett  
utting board · Tábua de corte

Ref	€	cm	h(cm)	U.Venta
60501	8,30	30x18	1	1
60502	11,40	36x22	1	1
60503	15,30	42x25,5	1	1

Tacos antideslizantes  
Non slip plugs



PE  
Polyethylene  
Dishwasher  
BPA free

**Tabla de corte polietileno**

Planche à découper en polyéthylène · Schneidebrett Polyethylen  
Polyethylene cutting board · Tábua de corte polietileno

Ref	€	h(cm)	U.Venta
60569	11,10	2,0	6
60455	21,70	2,0	6
60405	31,90	3,0	6
60456	42,90	2,0	1
60406	64,00	3,0	1
60575	124,20	5,0	1
60457	60,50	2,0	1
60407	89,60	3,0	1



**Tabla de corte**

Planche à découper · Schneidebrett  
Cutting board · Tábua de corte

GN 1/4 · 265x162 mm				GN 1/2 · 325x265 mm				GN 1/1 · 530x325 mm				600X400 mm			
Ref	€	h(cm)	U.Venta	Ref	€	h(cm)	U.Venta	Ref	€	h(cm)	U.Venta	Ref	€	h(cm)	U.Venta
60570	11,10	2,0	1	60470	21,70	2,0	1	60475	42,70	2,0	1	60600	60,80	2,0	1
60571	11,10	2,0	1	60471	21,70	2,0	1	60476	42,70	2,0	1	60601	60,80	2,0	1
60572	11,10	2,0	1	60472	21,70	2,0	1	60477	42,70	2,0	1	60602	60,80	2,0	1
60573	11,10	2,0	1	60473	21,70	2,0	1	60478	42,70	2,0	1	60603	60,80	2,0	1
-	-	-	-	-	-	-	-	60576	121,00	5,0	1	-	-	-	-
60574	11,10	2,0	1	60474	21,70	2,0	1	60479	42,70	2,0	1	60604	60,80	2,0	1
60577	11,10	2,0	1	60480	21,70	2,0	1	60481	42,70	2,0	1	60605	60,80	2,0	1

PE-500 (HD-HMW) High Molecular AA Weight Polyethylene

PE  
Polyethylene  
Dishwasher  
BPA free

**Cepillo para tablas de corte**

Brosse pour planche à découper · Brush für Schneidebrett  
Brush cutting board · Cepilho para tábua de corte

Ref	€	cm	h(cm)	U.Venta
60458	68,10	17x6	10	1

Tacos antideslizantes  
Non slip plugs



PE  
Polyethylene  
Dishwasher  
BPA free

**Tabla de corte antialérgica**

Planche à découper · Schneidebrett  
Anti-allergy cutting board · Tábua de corte

Ref	€	Medidas	h(cm)	U.Venta
60521	24,70	325x265 mm	20	1
60522	49,30	530x325 mm	20	1
60606	60,30	600x400 mm	20	1

- Diseñado para organizar hasta 6 tablas de corte de 3 cm de espesor.
- Multifuncional: apto para tablas, bandejas, moldes rígidos, etc.

- Designed to hold up to six 3 cm-thick cutting boards.
- Multifunctional: suitable for boards, trays, rigid moulds, etc.

- Pescado · Fish
- Verduras+frutas · Vegetables+Fruits
- Embutidos · Cold cred meat
- Carne · Meat
- Aves · Poultry
- Varios · Various



**Soporte tablas de corte**

Support pour planches à découper · Schneidbretthalter  
Cutting board rack · Suporte para tábuas de cortar

Ref	€	cm	h(cm)	U.Venta
60579	28,70	34x30	27,8	1

# Cubiertos

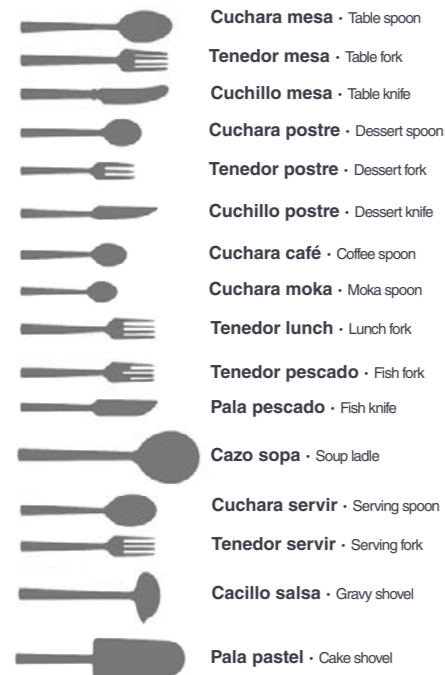

- Cuchara mesa · Table spoon
- Tenedor mesa · Table fork
- Cuchillo mesa · Table knife
- Cuchara postre · Dessert spoon
- Tenedor postre · Dessert fork
- Cuchillo postre · Dessert knife
- Cuchara café · Coffee spoon
- Cuchara moka · Moka spoon
- Tenedor lunch · Lunch fork
- Tenedor pescado · Fish fork
- Pala pescado · Fish knife
- Cazo sopa · Soup ladle
- Cuchara servir · Serving spoon
- Tenedor servir · Serving fork
- Cacillo salsa · Gravy shovel
- Pala pastel · Cake shovel

INOX

Hotel

Ref	€	U.Venta
33101	1,80	12
33102	1,80	12
33103	2,90	12
33104	1,40	12
33105	1,40	12
33106	2,80	12
33107	1,10	12
33108	0,90	12
33109	1,10	12

INOX 18/10

Aries

Ref	€	U.Venta
33401	2,80	12
33402	2,80	12
33403	6,20	12
33404	2,80	12
33405	2,80	12
33406	6,20	12
33407	1,40	12
33408	1,30	12
33409	1,80	12
33410	2,80	12
33411	2,80	12
33412	10,90	1
33413	6,70	1
33414	6,80	1
33415	8,60	1
33416	7,40	1

# Cuberteros

- Solución ideal para almacenar, guardar y conservar los cubiertos de forma organizada.
  - 5 compartimentos individuales apilados para diferentes tipos de cubiertos.
  - Iconos en cada compartimento para identificarlos fácilmente.
  - Diseñado para cajones con una altura mínima de 8 cm.
- Ideal solution for storing, keeping and preserving cutlery in a well-organised way.
- 5 individual stackable compartments for different types of cutlery.
- Easily recognisable icons on each compartment for clear identification.
- Suitable for drawers with a minimum height of 8 cm.



HAYA  
Wood

**Organizador de Cubiertos Compact**  
Range-couverts · Besteckkasten  
Cutlery Organiser · Organizador de talheres

Ref	€	cm	h(cm)	U.Venta
39050	27,40	39,5x12,2	6,0	1

- Solución ideal para almacenar, guardar y conservar los cuchillos de forma segura y organizada.
  - Diseñado para almacenar hasta 8 cuchillos con hojas de hasta 25 cm para cajones con una altura mín. de 8,5 cm.
  - Diseño de dos niveles:
    - a) Nivel superior para los cuchillos pequeños (4 unidades con longitud de hoja máx. de 13 cm).
    - b) Inferior para los grandes (4 unidades con longitud de hoja máxima de 25 cm).
- Ideal solution for storing, keeping and preserving knives in a safe and well organised way.
- Designed to store up to 8 knives with blades of up to 25 cm, and for drawers with a minimum 8.5 cm height.
- Two-tier design:
- a) Upper level for small knives (4 pieces with maximum blade length of 13 cm).
- b) Lower one for large knives (4 pieces with maximum blade length of 25 cm).



HAYA  
Wood

**Organizador de Cuchillos Compact**  
Organisateur de couteaux · Messerhalter  
Knife organiser · Organizador de facas

Ref	€	cm	h(cm)	U.Venta
39049	24,40	40,5x11	4,5	1

new



INOX Dishwasher

## Soporte para cubiertos con vasos

Porte couverts avec paniers · Besteckbehälter  
Cutlery holder w/cylinder · Sup. talheres com copos

Ref	€	cm	Orificios	U.Venta
33124	87,00	29x22x26	4	1
33126	106,90	29x22x38	6	1



## Contenedor cubiertos

Panier à couverts · Besteckköcher  
Cutlery holder · Copos para talheres

Ref	€	Ø (cm)	h(cm)	L	U.Venta
62962	21,60	12	13,6	1,40	1
62963	25,10	12	18,7	2,00	1

- Recipiente para cubiertos en color negro de polipropileno.
- Ideal para organizar y guardar los cubiertos y utensilios de la cocina.
- Apilable.

- Récipient de couverts en polypropylène noir.
- Idéal pour organiser et sauver les couverts et les ustensiles de cuisine.
- Empilable.

- Black polypropylene cutlery container.
- Ideal to organize and save the cutlery and kitchen utensils.
- Stackable.

PP Polypropylene BPA free

## Cubertero Ratán

Range-couverts · Besteckkasten  
Cutlery holder · Bandeja para talheres

Ref	€	cm	h(cm)	Compartimentos	U.Venta
A 63484	8,60	27x10	4,5	1	1
B 63485	8,60	Ø12	15,0	1	1
C 63491	76,80	53x32,5	9,0	4	1

INOX Dishwasher

## Vaso inox cubertería

Panier pour porte couvert · Besteckköcher  
St. steel cutlery cylinder · Copos p/talheres inox

Ref	€	h(cm)	U.Venta
33125	7,80	14	6

- Ideal para organizar y guardar los cubiertos y utensilios de la cocina.
- No se deforma con el peso de los cubiertos.
- Cómodo de transportar gracias a sus asas laterales.
- Apilable.

- Ideal to organize and save the cutlery and kitchen utensils.
- It does not deform with the weight of the cutlery.
- Comfortable to transport thanks to your lateral handles.
- Stackable.



PP Polypropylene BPA free  
Dishwasher

## Cubertero GN 1/1

Range-couverts · Besteckkasten  
Cutlery holder · Bandeja para talheres

Ref	€	cm	h(cm)	U.Venta
33121	11,50	52,5x32	9,5	1



03

Mesa  
Table Top

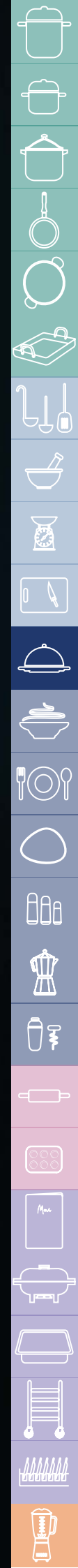

# Bandejas Inox

INOX  
Dishwasher  
Stackable



INOX  
18/10



## Fuente oval

Plat ovale · Buffet-Tablett, oval  
Oval dish · Travessa oval

Ref	€	cm	U.Venta
61820	6,10	20x13	1
61825	8,50	25x17	1
61830	9,30	30x20	1
61835	11,60	35x23	1
61840	14,00	40x26	1
61845	16,30	45x29	1
61850	20,00	50x31	1
61871	46,40	70x45	1
61881	54,20	80x48	1

## Fuente oval pulido satinado

Plat ovale poli-satine · Buffet-Tablett, oval  
Oval dish satin polish · Travessa oval pulido mate

Ref	€	cm	U.Venta
62820	8,80	20x13	1
62825	11,20	25x17	1
62830	14,00	30x20	1
62835	17,30	35x23	1
62840	22,70	40x26	1
62845	25,70	45x29	1
62850	30,90	50x31	1

## Fuente redonda

Plat rond · Bratenplatte, rund  
Round serving dish · Travessa redonda

Ref	€	Ø (cm)	U.Venta
61831	11,30	30	6
61836	14,10	35	6

## Fuente de pescado

Plat à poisson · Fischplatte  
Fish tray · Travessa peixe

Ref	€	cm	U.Venta
61860	28,90	60x27	1
61880	36,60	80x30	1

## Fuente honda oval

Plat à gratin ovale · Schale, oval  
Deep oval dish · Travessa funda oval

Ref	€	cm	h(cm)	U.Venta
61828	14,10	30x20	4,5	1
61832	17,20	35x24	4,5	1
61838	21,20	40x26	4,5	1
61843	22,80	45x29	4,5	1
61848	27,20	50x31	4,7	1

garinox®

## Bandeja de marisco

Plateau a fruit de mer · Platte für seemuschel  
Sea food tray · Bandeja de mariscos

Ref	€	Ø (cm)	U.Venta
14027	10,00	28	6
14042	22,20	42	1
14050	34,70	50	6

AL  
Aluminium

## Bandeja Master

Plateau · Platte  
Tray · Bandeja

Ref	€	cm	h(cm)	U.Venta
A 68465	23,70	45x33	5,0	1
B 68466	24,80	53x38	2,5	1



## Soporte para bandeja de mariscos

Support pour plateau a fruit de mer · Ständer für Seemuschelplatte,  
Stand for sea food tray · Suporte para bandeja de mariscos

Ref	€	Ø (cm)	Ød (cm)	h(cm)	U.Venta
14100	15,00	24,5	19	20	1



## Soporte para bandejas

Support pour plateaux · Tablethalter  
Tray stand · Suporte para bandejas

Ref	€	cm	h(cm)	U.Venta
61870	69,90	41,5x52	80	1



INOX  
18/10



## Bandeja camarero

Plateau limonadier · Serviertablett, rund  
Serving tray · Bandeja de servir

Ref	€	Ø (cm)	U.Venta
61841	21,60	40	1

## Bandeja camarero pulido satinado

Plateau limonadier poli-satine · Serviertablett, rund  
Serving tray satin polish · Bandeja de servir pulido mate

Ref	€	Ø (cm)	U.Venta
62841	28,70	40	1

## Bandeja camarero Garinox

Plateau limonadier · Serviertablett  
Serving tray · Bandeja de servir

Ref	€	Ø (cm)	U.Venta
14135	10,40	32	6
14136	12,00	36	1
14145	20,30	45	1



## Plato de huevos

Plat à oeufs · Eiteller  
Egg serving dish · Prato de ovos

Ref	€	Ø (cm)	h(cm)	U.Venta
61116	5,20	16	3	6

## Posabotellas

Dessous de bouteille · Flaschenuntersetzer  
Bottle stand · Pousa-garrafas

Ref	€	Ø (cm)	U.Venta
61113	3,90	13	6

## Posavasos

Sous-verre · Glasuntersetzer  
Glass stand · Pousa-copos

Ref	€	Ø (cm)	U.Venta
61110	3,30	10,5	6



INOX  
18/10

## Bandeja con pinza para notas

Porte addition à pince · Platte mit Klemmvorrichtung  
Bill holder · Bandeja com pinça para notas

Ref	€	cm	U.Venta
A 68007	5,40	11x15,2	12
B 68017	6,40	12x21,5	12

PP ABS  
Polypropylene Plastic

## Bandeja cambios Coin

Coupelle ramasse monnaie · Wechselgeldablagen  
Changetray · Bandeja para trocos

Ref	€	Ø (cm)	U.Venta
68720	3,20	13	12



## Plato camping

Plate de camping · Campingplatte  
Camping dinner plate · Prato camping

Ref	€	Ø (cm)	U.Venta
A 61121	7,20	22	1
B 61122	7,60	22	6

# Bandejas Fibreglass



- Para uso profesional.
- Fabricada en fibra de vidrio.
- Superficie antiadherente y antideslizante.
- Indeformable y muy ligera.

- Pour une utilisation professionnelle.
- Fabriqué en fibre de verre.
- Surface non étalée et non glissante.
- UNDEFORMABLE ET TRÈS LIGHT.

- For professional use.
- Manufactured in fiberglass.
- Non -striped and non -slip surface.
- Undeformable and very light.



## Bandeja redonda

Plateau rond · Serviertablett rund  
Round tray · Bandeja redonda

Ref	€	Ø (cm)	U.Venta
69136	14,50	36	1
69140	21,50	40	1

## Bandeja rectangular

Plateau rectangulare · Serviertablett, rechteckig  
Rectangular tray · Bandeja rectangular

Ref	€	cm	U.Venta
69146	25,20	36x46	1
69152	30,30	38x52	1
69156	38,50	40x56	6
69165	55,40	45x65	6

## Bandeja Oval

Plateau ovale · Oval Serviertablett  
Oval tray · Bandeja oval

Ref	€	cm	U.Venta
69168	65,90	56x68	6

# Bandejas Pizarra



- Totalmente artesanal, cada bandeja es única e irreplicable.
- Ideal para la presentación de platos fríos y calientes.
- Ofrece un aire de modernidad, elegancia y sencillez.
- Excelente conductor del frío y del calor.
- Evita los cambios bruscos de temperatura para su conservación.
- Contiene tacos antideslizantes para asegurar su estabilidad.
- **NOTA: para conservarla brillante y con su color natural, cada ciertos usos impregnar con aceite de oliva virgen extra por ambas caras y cantos.**

- Totalement fabriqué à la main, chaque plateau est unique et incompatable.
- Idéal pour la présentation des plats froids et chauds.
- Il offre un air de modernité, d'élégance et de simplicité.
- Excellent conducteur de froid et de chaleur.
- Évitez les changements soudains de température pour la conservation.
- Il contient des tacos sans glissement pour assurer sa stabilité.
- Remarque: Pour le garder brillant et avec sa couleur naturelle, chaque utilisation certaines imprégnait de l'huile d'olive extra vierge des deux côtés et des chansons.

- Totally handmade, each tray is unique and unrepeatable.
- Ideal for the presentation of cold and hot dishes.
- It offers an air of modernity, elegance and simplicity.
- Excellent driver of cold and heat.
- Avoid sudden changes in temperature for conservation.
- It contains non -slip tacos to ensure its stability.
- Note: To keep it bright and with its natural color, every certain uses permeate with extra virgin olive oil on both sides and songs.



## Bandeja redonda

Plateau rond · Serviertablett rund  
Round tray · Bandeja redonda

Ref	€	Ø (cm)	e (mm)	U.Venta
61070	3,60	20	5	6
61071	5,10	25	5	6
61072	7,10	30	5	6
61073	10,00	35	5	4
61078	10,10	40	5	4

## Bandeja cuadrada

Plateau carré · Serviertablett, viereckig  
Square tray · Bandeja quadrada

Ref	€	cm	e (mm)	U.Venta
61010	3,10	10x10	5	32
61015	4,50	15x15	5	32
61019	5,20	20x20	5	24
61044	16,40	40x40	5	8

## Bandeja rectangular

Plateau rectangulare · Serviertablett, rechteckig  
Rectangular tray · Bandeja rectangular

Ref	€	cm	e (mm)	U.Venta
61016	4,30	10x15	5	48
61021	5,00	15x20	5	24
61029	6,30	15x30	5	18
61031	7,90	20x30	5	12
61041	9,20	20x40	5	12
61051	13,00	20x50	5	8
61043	14,40	40x30	5	8
61064	29,30	60x40	5	3

Melamina  
Melamine



# Earth Collection

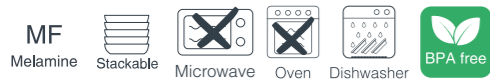

- Fabricada en melamina de alta calidad. Libre de BPA.
- Diseñada para realzar las creaciones del chef.
- Ligera, resistente a golpes y choques térmicos.
- Higiénica y fácilmente lavable. Apta para el lavavajillas.

- Fabriqué en mélamine de haute qualité. Sans BPA.
- Conçu pour améliorer les créations du chef.
- Léger, résistant aux coups et aux chocs thermiques.
- Hygénique et facilement lavable. Convient au lave-vaisselle.

- Made of high quality melamine. BPA free.
- Designed to enhance the creations of the chef.
- Light, resistant to blows and thermal shocks.
- Hygienic and easily washable. Suitable for dishwasher.



## Fuente rectangular Square

Plateau rectangulaire · Serviertablet, rechteckig  
Rectangular tray · Travessa rectangular

Ref	€	cm	h(cm)	U.Venta
63830	8,40	18,6x13,5	2,7	1



## Fuente rectangular

Plateau rectangulaire · Serviertablet, rechteckig  
Rectangular tray · Travessa rectangular

Ref	€	cm	h(cm)	U.Venta
63831	10,40	21,7x13,6	3,1	1
63832	12,70	25,2x17,2	3,6	1
63834	21,40	30,8x21,6	3,5	1
63855	29,30	35x23,8	4,1	1



## Fuente rectangular Long

Plateau rectangulaire · Serviertablet, rechteckig  
Rectangular tray · Travessa rectangular

Ref	€	cm	h(cm)	U.Venta
63833	11,70	28,6x12,7	3,4	1



## Fuente rectangular ondulada

Plateau rectang. ondulé · Serviertablet, rechteckig, gewellt  
Rectangular undulated tray · Travessa rectang. ondulada

Ref	€	cm	h(cm)	U.Venta
63865	18,90	29x17,5	3,0	1



## Fuente Oval

Plateau oval · Oval platte  
Oval tray · Travessa redonda

Ref	€	cm	h(cm)	U.Venta
63863	9,80	25,4x13	2,9	1



## Fuente lágrima

Plateau larme · Träne platte  
Tear tray · Travessa lágrima

Ref	€	cm	h(cm)	U.Venta
63854	17,20	28,4x19	5,1	1



## Fuente Oval alta

Plateau oval · Oval platte  
Oval tray · Travessa redonda

Ref	€	cm	h(cm)	U.Venta
63852	8,60	19,7x14,1	3,7	1
63853	11,80	22,5x16,4	4,4	1
63864	18,60	28,2x21,4	4,8	1



## Plato redondo

Plateau rond · Rund Teller  
Round plate · Prato redondo

Ref	€	Ø (cm)	h(cm)	U.Venta
63841	6,20	15,5	2,4	1
63842	9,20	19,4	2,9	1
63843	10,00	21,5	3,2	1
63844	15,70	24,2	3,5	1
63845	18,10	25,6	3,7	1



## Plato hondo redondo

Platteau profonde ronde · Rund tiefe Platte  
Round deep plate · Prato profundo redondo

Ref	€	Ø (cm)	h(cm)	U.Venta
63839	9,20	17,7	4,4	1
63840	19,40	24	5,5	1



## Fuente cuadrada

Plateau carrée · Quadratischen platte  
Square tray · Travessa quadrado

Ref	€	cm	h(cm)	U.Venta
63846	7,70	12x12	5,0	1
63847	16,20	19x19	6,0	1
63848	25,20	24x24	6,8	1



## Bol

Bol · Boul  
Bowl · Bacia

Ref	€	Ø (cm)	h(cm)	ml	U.Venta
63861	6,60	12,4	4,6	300	1



## Bol

Bol · Boul  
Bowl · Bacia

Ref	€	Ø (cm)	h(cm)	ml	U.Venta
63856	3,10	8,3	3,2	60	1
63857	4,90	9,5	4,6	130	1
63858	5,20	10,6	5,2	220	1
63859	7,20	12,6	6,0	300	1



## Bol oval

Bol oval · Oval bowl  
Oval bowl · Bacia oval

Ref	€	cm	h(cm)	ml	U.Venta
63849	4,60	12x10	4,1	130	1
63860	8,00	16,3x12,3	4,7	220	1
63850	16,00	20,7x16,8	8,0	660	1
63851	25,00	24,2x20,6	9,3	1150	1



## Bol cónico

Bol sauce mini · Boul Konish  
Conical bowl · Bacia cónica

Ref	€	Ø (cm)	h(cm)	ml	U.Venta
63835	9,00	15,5	6	330	1
63836	11,00	18,5	7	560	1
63837	14,50	21,5	8	750	1
63838	20,40	24,0	9	1350	1



## Bol salsa mini

Bol sauce mini · Boul sauce min  
Sauce bowl mini · Bacia molho mini

Ref	€	cm	h(cm)	ml	U.Venta
63862	3,00	7,2x7,2	3,0	30	1



# Sea Collection

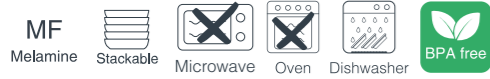

- Fabricada en melamina de alta calidad. Libre de BPA.
- Una completa gama que ofrece un aspecto rústico, con piezas únicas y elegantes.
- Diseñada para realzar las creaciones del chef.
- Ligera, resistente a golpes y choques térmicos.
- Higiénica y fácilmente lavable. Apta para el lavavajillas.

- Fabriqué en mélamine de haute qualité. Sans BPA.
- Une gamme complète qui offre une apparence rustique, avec des pièces uniques et élégantes.
- Conçu pour améliorer les créations du chef.
- Léger, résistant aux coups et aux chocs thermiques.
- Hygiénique et facilement lavable. Convient au lave-vaisselle.

- Made of high quality melamine. BPA free.
- A complete range that offers a rustic appearance, with unique and elegant pieces.
- Designed to enhance the creations of the chef.
- Light, resistant to blows and thermal shocks.
- Hygienic and easily washable. Suitable for dishwasher.



## Fuente rectangular Square

Plateau rectangulaire · Serviertablet, rechteckig  
Rectangular tray · Travessa rectangular

Ref	€	cm	h(cm)	U.Venta
63941	8,40	18,6x13,5	2,7	1

## Fuente rectangular

Plateau rectangulaire · Serviertablet, rechteckig  
Rectangular tray · Travessa rectangular

Ref	€	cm	h(cm)	U.Venta
63942	10,40	21,7x13,6	3,1	1
63943	12,70	25,2x17,2	3,6	1
63945	21,40	30,8x21,6	3,5	1
63966	29,30	35x23,8	4,1	1

## Fuente rectangular Long

Plateau rectangulaire · Serviertablet, rechteckig  
Rectangular tray · Travessa rectangular

Ref	€	cm	h(cm)	U.Venta
63944	11,70	28,6x12,7	3,4	1



## Fuente rectangular ondulada

Plateau rectang. ondulé · Serviertablet, rechteckig, gewellt  
Rectangular undulated tray · Travessa rectang. ondulada

Ref	€	cm	h(cm)	U.Venta
63976	18,90	29x17,5	3,0	1

## Fuente Oval

Plateau oval · Oval platte  
Oval tray · Travessa redonda

Ref	€	cm	h(cm)	U.Venta
63974	9,80	25,4x13	2,9	1

## Fuente lágrima

Plateau larme · Träne platte  
Tear tray · Travessa lágrima

Ref	€	cm	h(cm)	U.Venta
63965	17,20	28,4x19	5,1	1

## Fuente Oval alta

Plateau oval · Oval platte  
Oval tray · Travessa redonda



Ref	€	cm	h(cm)	U.Venta
63963	8,60	19,7x14,1	3,7	1
63964	11,80	22,5x16,4	4,4	1
63975	18,60	28,2x21,4	4,8	1

## Plato redondo

Plateau rond · Rund Teller  
Round plate · Prato redondo



Ref	€	Ø (cm)	h(cm)	U.Venta
63952	6,20	15,5	2,4	1
63953	9,20	19,4	2,9	1
63954	10,00	21,5	3,2	1
63955	15,70	24,2	3,5	1
63956	18,10	25,6	3,7	1



## Plato hondo redondo

Plateau profonde ronde · Rund tiefe Platte  
Round deep plate · Prato profundo redondo

Ref	€	Ø (cm)	h(cm)	U.Venta
63950	9,20	17,7	4,4	1
63951	19,40	24	5,5	1



## Fuente cuadrada

Plateau carrée · Quadratischen platte  
Square tray · Travessa quadrado

Ref	€	cm	h(cm)	U.Venta
63957	7,70	12x12	5,0	1
63958	16,20	19x19	6,0	1
63959	25,20	24x24	6,8	1



## Bol

Bol · Boul  
Bowl · Bacia

Ref	€	Ø (cm)	h(cm)	ml	U.Venta
63972	6,60	12,4	4,6	300	1



## Bol

Bol · Boul  
Bowl · Bacia

Ref	€	Ø (cm)	h(cm)	ml	U.Venta
63967	3,10	8,3	3,2	60	1
63968	4,90	9,5	4,6	130	1
63969	5,20	10,6	5,2	220	1
63970	7,20	12,6	6,0	300	1



## Bol oval

Bol oval · Oval boul  
Oval bowl · Bacia oval

Ref	€	cm	h(cm)	ml	U.Venta
63960	4,60	12x10	4,1	130	1
63971	8,00	16,3x12,3	4,7	220	1
63961	16,00	20,7x16,8	8,0	660	1
63962	25,00	24,2x20,6	9,3	1150	1



## Bol cónico

Conique bol · Boul Konish  
Conical bowl · Bacia cónica

Ref	€	Ø (cm)	h(cm)	ml	U.Venta
63946	9,00	15,7	5,9	330	1
63947	11,00	18,3	6,8	560	1
63948	14,50	21,3	7,8	750	1
63949	20,40	24,2	8,8	1350	1



## Bol salsa mini

Bol sauce mini · Boul sauce min  
Sauce bowl mini · Bacia molho mini

Ref	€	cm	h(cm)	ml	U.Venta
63973	3,00	7,2x7,2	3,0	30	1

# Classic Collection

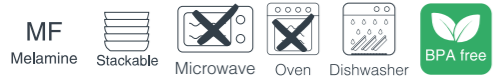

• Una completa gama contemporánea en blanco y negro. Diseñada para realzar las creaciones del chef. Apilables, aptos para el lavavajillas y 100% libre de BPA.

• Une gamme contemporaine complète en noir et blanc. Conçue pour mettre en valeur les créations du chef. Empilables, ils passent au lave-vaisselle et sont 100 % sans BPA.

• A complete contemporary range in black and white. Designed to enhance the chef's creations. Stackable, dishwasher safe and 100% BPA free.

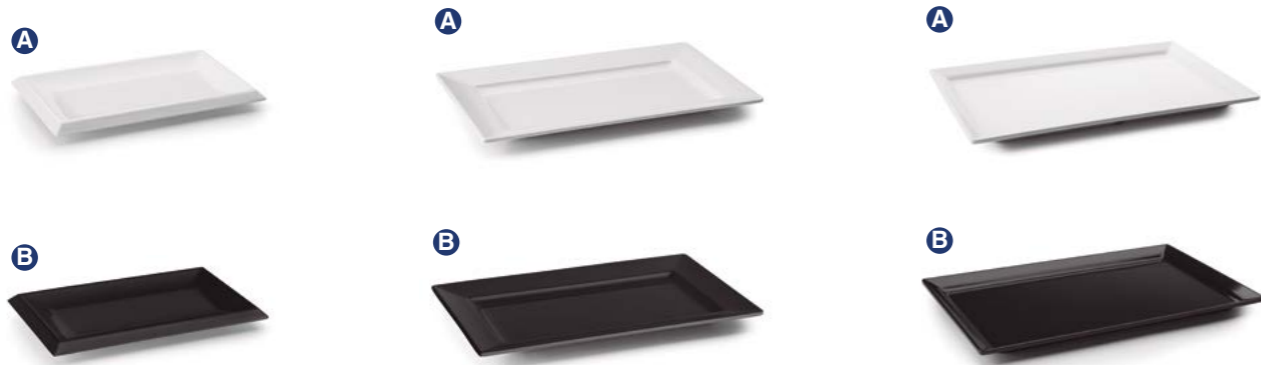

Bandeja rectangular S

Bandeja rectangular M

Bandeja rectangular L

	Ref	€	cm	h(cm)	U.Venta
<b>A</b>	63531	8,80	26x16	2	6
	63532	14,80	30x22	2	6
<b>B</b>	63541	8,80	26x16	2	6
	63542	14,80	30x22	2	6

	Ref	€	cm	h(cm)	U.Venta
<b>A</b>	63533	19,10	30x21	3	6
	63534	22,60	35x21	2	6
<b>B</b>	63543	19,10	30x21	3	6
	63544	23,30	35x21	2	6

	Ref	€	cm	h(cm)	U.Venta
<b>A</b>	63535	38,30	53x32	3	6
	63536	55,70	70x30	2	3
<b>B</b>	63545	38,70	53x32	3	6
	63546	55,70	70x30	2	3



Fuente oval

Plateau oval · Oval platte  
Oval tray · Travessa redonda

	Ref	€	cm	h (cm)	L	U.Venta
<b>A</b>	63557	10,00	32x12	6	0,85	6
	63558	15,90	41,5x17	8	2,20	6
<b>B</b>	63567	10,00	32x12	6	0,85	6
	63568	15,90	41,5x17	8	2,20	6



Fuente pescado

Plateau poisson · Fischplatte  
Fish tray · Travessa peixe

	Ref	€	cm	h (cm)	U.Venta
<b>A</b>	63589	31,30	57x22	4	1
<b>B</b>	63599	31,30	57x22	4	1



Bandeja delicatessen con mango

Plateau delicatessen · Schüssel delicatessen  
Delicatessen tray · Bandeja delicatessen

	Ref	€	cm	U.Venta
<b>A</b>	63609	3,60	9,5x9,5	6
<b>B</b>	63619	3,60	9,5x9,5	6



Bandeja delicatessen

Plateau delicatessen · Schüssel delicatessen  
Delicatessen tray · Bandeja delicatessen

	Ref	€	cm	h (cm)	U.Venta
<b>A</b>	63610	3,10	10x10	2,5	6
<b>B</b>	63617	3,10	10x10	2,5	6

Fuente redonda White

Plateau rond · Rundplatte  
Round tray · Travessa redonda

	Ref	€	Ø (cm)	h(cm)	U.Venta
	63551	29,70	40,0	6,0	6
	63552	39,50	44,5	6,5	1



Fuente cuadrada White

Plateau rectangulaire · Serviertablet, rechteckig  
Rectangular tray · Travessa quadrada

	Ref	€	cm	h(cm)	L	U.Venta
	63573	29,00	33,5x33,5	8,5	5,0	1



Fuente White

Plateau · Serviertablet  
Tray · Travessa

	Ref	€	Ø (cm)	h(cm)	L	U.Venta
	63577	27,30	35,5	11	4,0	6



Portartartas

Gueridon pâtisier · Kuchenplatte  
Cake stand · Porta-tartes

	Ref	€	Ø (cm)	h(cm)	U.Venta
	63586	33,40	30	9,0	4



Bol redondo White

Bol rond · Schale rund  
Round bowl · Bacia redonda

	Ref	€	Ø (cm)	h(cm)	L	U.Venta
	63553	16,20	22	10,0	2,4	6
	63554	24,00	28	10,0	4,0	6
	63555	33,40	33	13,0	7,0	6
	63556	41,50	38	14,5	11,0	2



Bol Oval White

Bol oval · Schale oval  
Oval bowl · Bacia oval

	Ref	€	cm	h(cm)	L	U.Venta
	63585	24,30	29x26	16	4,0	6



Ribbed bol

Ribbed bol · Schale gerippt  
Bowl Ribbed · Bacia Ribbed

	Ref	€	Ø (cm)	h(cm)	L	U.Venta
	63611	2,50	7,0	3	0,05	6
	63612	2,90	8,5	4	0,10	6







**Bol ensalada**  
Bac salade · Schüssel  
Salad bowl · Bacia de salada

Ref	€	cm	h (cm)	L	U.Venta
63570	8,10	13x13	6	0,5	6
63571	20,30	19x19	9	2,0	1
63572	39,60	25x25	12	4,8	1
63580	8,10	13x13	6	0,5	6
63581	20,30	19x19	9	2,0	1
63582	39,60	25x25	12	4,8	1

**Bandeja oval**  
Plateau ovale · Serviertablett oval  
Oval tray · Bandeja oval

Ref	€	cm	h (cm)	U.Venta
62751	4,30	20,7x14,4	1,8	10
62753	6,40	25,0x18,3	2,2	10
62754	7,00	28,0x20,0	2,4	10
62755	8,20	31,4x23,4	2,5	10
62756	10,40	33,5x25,8	2,6	10
62757	11,50	32,6x28,5	2,7	10
62759	17,00	45,8x34,8	3,0	10



**Bandeja redonda**  
Plateau rond · Serviertablett rund  
Round tray · Bandeja redonda

Ref	€	Ø (cm)	h (cm)	U.Venta
62761	4,40	18,0	2,4	10
62762	5,20	20,0	2,5	10
62764	7,60	25,4	2,9	10
62766	12,50	30,7	3,3	10
62768	15,00	35,5	3,2	10
62769	21,60	40,0	3,5	6

**Bandeja redonda ondulada**  
Plateau rond ondulé · Rund Teller gewellt  
Undulated round plate · Prato redondo ondulado

Ref	€	Ø (cm)	h (cm)	U.Venta
62770	6,60	20,7	2,8	10
62771	11,00	25,0	3,0	1
62772	12,80	29,5	3,1	1

**Bandeja rectangular**  
Plateau rectangulaire · Serviertablet, rechteckig  
Rectangular tray · Bandeja rectangular

Ref	€	cm	h (cm)	U.Venta
62791	7,50	24,8x16,0	2,3	10
62792	10,90	28,0x19,0	2,3	10
62793	12,50	30,0x20,8	2,3	10



**Bol redondo**  
Bac rond · Schüssel, rund  
Round bowl · Bacia refondo

Ref	€	Ø (cm)	h (cm)	L	U.Venta
62785	3,80	11,8	5,1	0,30	10
62786	4,50	12,8	5,7	0,40	10
62787	5,30	14,9	6,5	0,60	10

**Bol cuadrado**  
Bac carre · Schüssel, viereckig  
Square bowl · Bacia quadrada

Ref	€	cm	h (cm)	L	U.Venta
62780	4,30	12,3x12,3	6,3	0,40	10
62781	5,00	14,9x14,9	7,0	0,70	10
62782	6,30	17,3x17,3	7,9	1,00	10
62783	8,20	19,7x19,7	8,8	1,50	1
62784	10,90	21,5x21,5	9,5	2,00	1



**Cuchara lisa**  
Cuillère lisse · ServierLöffel  
Plain spoon · Colher lisa

Ref	€	Largo (cm)	U.Venta
63600	1,00	18	6



**Cacillo**  
Louche · Schöpfkelle  
Soup ladle · Concha

Ref	€	Largo (cm)	ml	U.Venta
63602	3,00	27	150	6
63605	3,00	27	-	6



**Cuchara**  
Cuillère · Löffel  
Spoon · Colher

Ref	€	Largo (cm)	ml	U.Venta
63601	1,80	25	40	6
63604	2,60	30	50	6
63603	2,50	30	-	6

# White & Black



- Fabricado en melamina de alta calidad. Libre de BPA.
- Diseñado para realizar las creaciones del chef.
- Ligero, resistente a golpes y choques térmicos.
- Higiénico y fácilmente lavable, apto para el lavavajillas.

- Fabriqué en mélamine de haute qualité. Sans BPA.
- Conçu pour améliorer les créations du chef.
- Léger, résistant aux coups et aux chocs thermiques.
- Hygiénique et facilement lavable, adapté au lave-vaisselle.

- Made of high quality melamine. BPA free.
- Designed to enhance the creations of the chef.
- Light, resistant to blows and thermal shocks.
- Hygienic and easily washable, suitable for dishwasher.



**Bol cónico**  
Conique bol · Schale konisch  
Conical bowl · Bacia cónica

Ref	€	Ø (cm)	h (cm)	L	U.Venta
63261	9,90	17	7,0	0,70	6
63262	11,80	21	8,0	1,25	6
63263	13,50	25	8,5	1,80	6
63361	9,90	17	7,0	0,70	6
63362	11,80	21	8,0	1,25	6
63363	13,50	25	8,5	1,80	6



**Bol oval**  
Bol oval · Oval bowl  
Oval bowl · Bacia ova

Ref	€	cm	h (cm)	L	U.Venta
63268	8,00	17x14	6	0,40	6
63269	18,00	24x20	9	1,70	6
63368	8,00	17x14	6	0,40	6
63369	18,00	24x20	9	1,70	6



**Fuente redonda**  
Plateau rond · Rundplatte  
Round tray · Travessa redonda

Ref	€	Ø (cm)	h (cm)	L	U.Venta
63267	30,60	31	8	3,0	6
63367	30,60	31	8	3,0	6



**Bol redondo**  
Bac rond · Schüssel, rund  
Round bowl · Bacia refondo

Ref	€	Ø (cm)	h (cm)	L	U.Venta
63264	7,80	12,5	7,5	0,45	6
63265	9,00	14,0	7,5	0,60	6
63364	7,80	12,5	7,5	0,45	6
63365	9,00	14,0	7,5	0,60	6



**Bol luna**  
Bol · Schale  
Bowl · Bacia

Ref	€	Ø (cm)	h (cm)	U.Venta
63284	2,30	8	5,0	1
63285	10,70	16	9,5	1
63286	15,50	19	11,5	1
63404	2,30	8	5,0	1
63405	10,80	16	9,5	1
63406	15,50	19	11,5	1



**Fuente oval**  
Plateau oval · Oval platte  
Oval tray · Travessa redonda

Ref	€	cm	h (cm)	U.Venta
63275	13,70	32x14	4	6
63375	13,70	32x14	4	6

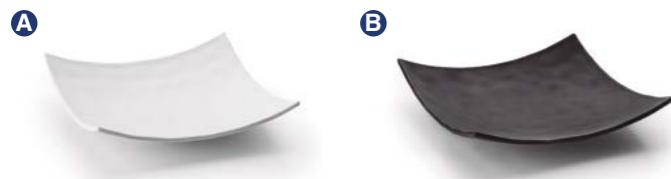

### Fuente cuadrada

Plateau carrée · Quadratischen platte  
Square tray · Travessa quadrado

	Ref	€	cm	h (cm)	U.Venta
A	63272	7,60	19x19	4	6
	63273	16,30	25x25	5	6
B	63372	7,60	19x19	4	6
	63373	16,30	25x25	5	6



### Bol salsa

Bac sauce · Schüssel saucen  
Sauce bowl · Bacia molho

	Ref	€	cm	h (cm)	L	U.Venta
A	63270	6,10	14x12	5	0,25	6
B	63370	6,10	14x12	5	0,25	6



### Fuente rectangular

Plateau rectangulaire · Serviertablet, rechteckig  
Rectangular tray · Travessa rectangular

	Ref	€	cm	h (cm)	U.Venta
A	63274	9,90	25x17,5	3	6
B	63374	9,90	25x17,5	3	6



### Fuente salsa mini

Plateau sauce mini · Serviertablet sauce mini  
Sauce tray mini · Travessa molho min

	Ref	€	cm	h (cm)	U.Venta
A	63279	4,10	9x7	3	6
B	63379	4,10	9x7	3	6



### Fuente 3 salsas

Plateau 3 sauces · Serviertablet 3 sauces  
3 sauces tray · Travessa 3 molhos

	Ref	€	cm	h (cm)	U.Venta
A	63280	5,60	19x8	3	6
B	63380	5,60	19x8	3	6

### Vaso

Timbale · Trinkbecher  
Tumbler · Copo

	Ref	€	Ø (cm)	h (cm)	L	U.Venta
A	63350	3,50	7,3	7,7	0,32	1
B	63351	3,50	7,3	7,7	0,32	1



### Cuchara snack

Cuillère snack · Löffel snack  
Snack spoon · Colher snack

	Ref	€	cm	h (cm)	U.Venta
A	63287	3,70	14,5x14,5	4,5	1
B	63407	3,70	14,5x14,5	4,5	1

### Bandeja 3 boles

Plateau avec 3 bols · Platte mit 3 Schalen  
Tray with 3 bowls · Bandeja com 3 tijelas

Ref	€	Ø (cm)	cm	h(cm)	ml	U.Venta
63403	14,60	8	27x11	1,0	120 (x3)	1

### Set 6 boles mini

Plateau avec 3 bols Black · Bandeja 3 Schalen Schwarz  
Tray with 3 bowls Black · Bandeja 3 taças Preto

Ref	€	Ø (cm)	h(cm)	U.Venta
63408	9,40	6	7	1



# Stone Collection



- Fabricado en melamina de alta calidad. Libre de BPA.
- Combina formas naturales con aspecto elegante parecido al mármol.
- Diseñado para realizar las creaciones del chef.
- Ligero, resistente a golpes y choques térmicos.
- Higiénico y fácilmente lavable, apto para el lavavajillas.

- Fabriqué en mélamine de haute qualité. Sans BPA.
- Il combine des formes naturelles avec une apparence élégante similaire au marbre.
- Conçu pour améliorer les créations du chef.
- Léger, résistant aux coups et aux chocs thermiques.
- Hygiénique et facilement lavable, adapté au lave-vaisselle.

- Made of high quality melamine. BPA free.
- It combines natural forms with elegant appearance similar to marble.
- Designed to enhance the creations of the chef.
- Light, resistant to blows and thermal shocks.
- Hygienic and easily washable, suitable for dishwasher.



### Plato redondo

Plateau rond · Rund Plate  
Round plate · Prato redondo

Ref	€	Ø (cm)	h(cm)	U.Venta
63180	36,00	35	3,0	1
63181	54,90	44	3,0	1
63182	82,20	55	3,0	1



### Bandeja cuadrada

Plateau carrée · Quadratischen platte  
Square tray · Travessa quadrado

Ref	€	cm	h(cm)	U.Venta
63187	26,00	28,5x28,5	0,9	1



### Bandeja rectangular

Plateau rectangulaire · Serviertablet, rechteckig  
Rectangular tray · Bandeja rectangular

Ref	€	cm	h(cm)	U.Venta
63188	31,30	35x28,5	0,9	1
63189	39,60	43x28,5	0,9	1
63190	58,70	53x32	0,9	1



### Fuente oval

Carrée ovale · Schale oval  
Oval tray · Travessa oval

Ref	€	cm	h(cm)	U.Venta
63183	47,10	65x26	3,0	1



### Fuente huevo

Plat oeufs · Eier platte  
Egg plate · Travessa ovo

Ref	€	cm	h(cm)	U.Venta
63184	35,10	40,7x30,5	4,3	1



### Tabla con mango

Planche avec manche · Servierbrett mit Griff  
Board with grip · Tábua com mango

Ref	€	cm	h(cm)	U.Venta
63185	24,00	40x19,5	0,9	1
63186	33,00	46x25	0,9	1



### Fuente hoja

Palt feuille · Bratt platte  
Leaf plate · Travessa folha

Ref	€	cm	h(cm)	U.Venta
63191	22,00	40x25,3	4,3	1
63192	39,00	53x33	4,3	1

# Wood Collection

new



- Fabricadas en melamina de máxima calidad, 100% libre de BPA.
- Ofrecen un aspecto muy natural parecido a la madera.
- Ideales para servir y presentar cualquier alimento.
- Ligeras y resistentes.
- Higiénicas y fáciles de limpiar, aptas para el lavavajillas.

- Fabriqués en mélamine de qualité supérieure, 100% sans BPA.
- Ils offrent un aspect bois très naturel.
- Idéals pour le service et la présentation de tous les aliments.
- Légers et résistants.
- Hygiéniques et faciles à nettoyer, ils passent au lave-vaisselle.

- Made of top quality melamine, 100% BPA free.
- They offer a very natural wood-like appearance.
- Ideal for serving and presenting any food.
- Light and resistant.
- Hygienic and easy to clean, dishwasher safe.



## Bol rectangular

Bol rectangulaire · Rechteckige Schale  
Rectangular bowl · Bacia rectangular

Ref	€	cm	h(cm)	L	U.Venta
63092	18,20	17,5x16	8,0	1,30	1
63093	30,70	32,5x17,5	8,0	3,00	1
63094	35,40	53x16	8,0	4,50	1



## Bol redondo

Bol rond · Schale, rond  
Round bowl · Bacia redonda

Ref	€	Ø (cm)	h(cm)	L	U.Venta
63080	10,60	12,5	4,5	0,30	1
63081	15,20	15,5	5,5	0,50	1
63082	24,20	20,5	7,5	1,30	1



## Bandeja serve

Plateau Serve · Serve Serviertablet  
Serve tray · Bandeja Serve

Ref	€	cm	h(cm)	U.Venta
63090	24,40	45x17,5	1,5	1
63091	32,70	53x20	1,5	1



## Bandeja rectangular

Plateau rectangulaire · Serviertablet, rechteckige  
Rectangular tray · Bandeja rectangular

Ref	€	cm	h(cm)	U.Venta
63086	20,50	32,5x17,5	1,0	1
63087	34,00	32,5x26,5	1,0	1
63088	65,70	53x32,5	1,0	1
63089	30,30	53x16	1,0	1



## Plato redondo

Plateau rond · Plate, rond  
Round plate · Prato redondo

Ref	€	Ø (cm)	h(cm)	U.Venta
63083	6,10	15	1,5	1
63084	12,10	20	2,0	1
63085	20,10	26	2,2	1

Servicio mesa  
Table service





## Mini Serve Melamina

new



- **Mini cacerola con tapa fabricada en melamina de máxima calidad, 100% libre de BPA.**
- **Ofrece un aspecto muy natural parecido a la porcelana.**
- **Ideal para servir y presentar los platos más exquisitos.**
- **Ligera y resistente.**
- **Higiénica y fácil de limpiar, apta para el lavavajillas.**

- Mini-casserole avec couvercle en mélamine de qualité supérieure, 100 % sans BPA.
- Elle a un aspect très naturel, semblable à celui de la porcelaine.
- Idéale pour servir et présenter les plats les plus exquis.
- Légère et résistante.
- Hygiénique et facile à nettoyer, lavable au lave-vaisselle.

- Mini casseroles with lid made of top quality, 100% BPA-free melamine.
- Very natural porcelain-like appearance.
- Perfect for serving and presenting the most exquisite dishes.
- Lightweight and robust.
- Hygienic, easy to clean and dishwasher safe.

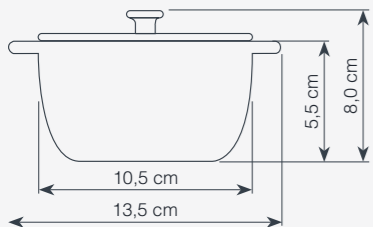

### Mini cocotte Serve

Mini cocotte · Mini cocotte  
Mini cocotte · Mini cocotte

	Ref	€	cm	h(cm)	ml	Color	U.Venta
<b>A</b>	63200	20,10	13,5x10,5	5,5	350	Rojo · Red	1
<b>B</b>	63201	20,10	13,5x10,5	5,5	350	Azul · Blue	1
<b>C</b>	63202	20,10	13,5x10,5	5,5	350	Gris · Grey	1



## Magma Melamina



- **Fabricadas en melamina de alta calidad.**
- **Libres de BPA.**
- **Ofrecen un aspecto muy natural parecido al hierro fundido.**
- **Ideales para servir y presentar los platos más exquisitos.**

- Fabriqué en mélamine de haute qualité.
- Sans BPA.
- Aspect très naturel, semblable à la fonte d'aluminium.
- Idéale pour servir et présenter les plats les plus exquis.

- Made of high quality melamine.
- BPA free.
- Very natural appearance similar to cast iron.
- Perfect for serving and presenting the most exquisite dishes.



### Cacerola redonda

Faitout rond · Rund Bratentopf  
Round casserole · Caçarola redonda

Ref	€	Ø (cm)	U.Venta
63384	5,20	16	12
63385	6,40	18	12



### Cacerola oval

Faitout ovale · Oval Bratentopf  
Oval casserole · Caçarola roval

Ref	€	cm	U.Venta
63388	4,60	18x12	12
63389	6,00	21x15	12



### Wok

Wok · Wok  
Wok · Wok

Ref	€	Ø (cm)	U.Venta
63386	4,40	15	12
63387	6,10	18	12



### Mini sartén

Mini pôele · Mini Pflanne  
Mini frying pan · Mini sertã

Ref	€	Ø (cm)	U.Venta
63381	7,20	15	6



### Mini grill

Mini grill · Mini grill  
Mini grill · Mini grill

Ref	€	cm	U.Venta
63382	7,60	13,5x13,5	6



### Mini sartén rectangular

Mini pôele rectangulare · Mini Pflanne, rechteckiger  
Rectangular Mini frying pan · Mini sertã rectangular

Ref	€	cm	U.Venta
63383	5,20	17x11,5	12



## Mini Cocotte Melamina

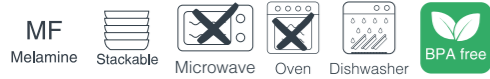

- Fabricada en melamina de alta calidad. Libre de BPA.
- Ofrece un aspecto muy natural parecido al hierro fundido.
- Ideal para servir y presentar los platos más exquisitos.

- Fabriqué en mélamine de haute qualité. Sans BPA.
- Il offre un aspect très naturel similaire à la fonte.
- Idéal pour servir et présenter les plats les plus exquis.

- Made of high quality melamine. BPA free.
- It offers a very natural aspect similar to cast iron.
- Ideal to serve and present the most exquisite dishes.

### Cacerola Black

Faitout · Bratentopf  
Casserole · Caçarola

	Ref	€	Ø (cm)	h(cm)	ml	U.Venta
<b>A</b>	63390	4,50	9	4,5	150	1
<b>B</b>	63391	12,10	18x8,5	5,0	480	1
<b>C</b>	63392	11,40	10	4,5	210	1
	63393	20,60	14	6,5	640	1



### Cacerola Red

Faitout · Bratentopf  
Casserole · Caçarola

	Ref	€	Ø (cm)	h(cm)	ml	U.Venta
<b>A</b>	63394	4,50	9	4,5	150	1
<b>B</b>	63395	12,10	18x8,5	5,0	480	1
<b>C</b>	63396	11,40	10	4,5	210	1
	63397	20,60	14	6,5	640	1



### Cacerola Grey

Faitout · Bratentopf  
Casserole · Caçarola

	Ref	€	Ø (cm)	h(cm)	ml	U.Venta
<b>A</b>	63398	4,50	9	4,5	150	1
<b>B</b>	63399	12,10	18x8,5	5,0	480	1
<b>C</b>	63400	11,40	10	4,5	210	1
	63401	20,60	14	6,5	640	1



## Batería Mini



### Cacerola con tapa

Faitout avec couvercle · Bratentopf mit Deckel  
Casserole with lid · Caçarola com tampa

Ref	€	Ø (cm)	Ød (cm)	h(cm)	L	U.Venta
25160	21,50	16	12	5,0	0,8	1



### Cazo

Casserole · Stielkasserole, flach  
Saucepan · Caçarola direite

Ref	€	Ø (cm)	Ød (cm)	h(cm)	L	U.Venta
25164	16,60	14	10	8,0	1,0	1



### Paellera

Plat à paella · Pfanne  
Round dish · Paelheira

Ref	€	Ø (cm)	Ød (cm)	h(cm)	L	U.Venta
25161	21,50	20	11,5	4,5	1,0	1



### Sartén

Poêle · Pfanne  
Frying pan · Sertã

Ref	€	Ø (cm)	Ød (cm)	h(cm)	U.Venta
25163	13,20	14	10,0	3,0	1



### Grill

Grill · Grill Induktionfähig  
Grill · Grelhador

Ref	€	cm	Ød (cm)	h(cm)	U.Venta
25162	14,50	14x14	10,0	2,5	1



## Mini Cocottes



**HINWEIS:** In Deutschland nicht verfügbar

- Fabricada en aluminio fundido. Diseño atractivo y funcional.
- Garantiza la absorción y distribución uniforme del calor, sin puntos de sobrecalentamiento.
- La distribución del calor uniforme por toda la pieza hace que los alimentos no pierdan su jugo durante la cocción, conservando así todos sus nutrientes y vitaminas.
- Es la pieza perfecta para: arroces, carnes, pescados, legumbres, verduras, guisos, cremas, salsas, sopas, etc.
- Revestimiento antiadherente ILAG:ULTIMATE.

- Fabriqué en aluminium fondu. Conception attrayante et fonctionnelle.
- Il garantit l'absorption et la distribution uniformes de la chaleur, sans surchauffe.
- La distribution de la chaleur uniforme dans toute la pièce fait que les aliments ne perdent pas leur jus pendant la cuisson, conservant ainsi tous ses nutriments et vitamines.
- C'est la pièce parfaite pour: le riz, les viandes, le poisson, les légumineuses, les légumes, les ragoûts, les crèmes, les sauces, les soupes, etc.
- Ilag: Ultime.

- Manufactured in molten aluminum. Attractive and functional design.
- It guarantees the uniform absorption and distribution of heat, without overheating points.
- The distribution of uniform heat throughout the piece causes food not to lose their juice during cooking, thus retaining all its nutrients and vitamins.
- It is the perfect piece for: rice, meats, fish, legumes, vegetables, stews, creams, sauces, soups, etc.
- Ilag: Ultimate.

### Cacerola con tapa Mini

Faitout avec couvercle "MINI" · "MINI" Bratentopf mit Deckel  
"MINI" round casserole with lid · Caçarola com tampa "MINI"

	Ref	€	Ø (cm)	h(cm)	L	U.Venta
<b>A</b>	25909	23,10	10	5,0	0,24	12
	25914	33,90	14	7,5	0,90	1
<b>B</b>	25910	23,10	10	5,0	0,24	1
	25915	33,90	14	7,5	0,90	1



### Cacerola oval con tapa Mini

Faitout Ovale avec couvercle "MINI" · "MINI" Oval Bratentopf mit Deckel  
"MINI" oval round casserole with lid · Caçarola oval com tampa "MINI"

	Ref	€	Ø (cm)	h(cm)	L	U.Venta
<b>A</b>	25911	24,30	12x8,5	5,0	0,25	1
<b>B</b>	25912	23,00	12x8,5	5,0	0,25	1



# Magma Collection



- Construida en una sola pieza.
- Recubierta con una capa de aceite vegetal.
- Ideal para cocinar, prolonga suavemente la cocción.
- Gran conductor del calor, mantiene el calor mientras disfrutas y saboreas la comida.
- Base de madera para servir y presentar la comida recién cocinada.

- Construit en un seul morceau.
- Recouvert d'une couche d'huile végétale.
- Idéal pour la cuisine, la cuisine doucement prolongée.
- Excellent conducteur de chaleur, gardez la chaleur tout en profitant et sauvant la nourriture.
- Base de bois pour servir et présenter des aliments fraîchement cuits.

- Built in one piece.
- Covered with a layer of vegetable oil.
- Ideal for cooking, gently prolonged cooking.
- Great heat driver, keep heat while enjoying and savors the food.
- Wood base to serve and present freshly cooked food.



## Cacerola

Faitout · Bratentopf  
Casserola · Caçarola

Ref	€	Ø (cm)	ml	U.Venta
25771	11,00	12,5	230	4
25772	16,00	16,2	470	4
25773	19,30	18,5	720	1



## Cacerola con base

Faitout avec basse · Bratentopf mit Holzsockel  
Casserola with base · Caçarola com base

Ref	€	Ø (cm)	ml	U.Venta
25871	15,80	12,5	230	4
25872	21,60	16,2	470	1
25873	27,70	18,5	720	1



## Cacerola oval

Faitout ovale · Oval Bratentopf  
Oval casserola · Caçarola oval

Ref	€	cm	ml	U.Venta
25781	12,40	15x10	200	4
25782	19,50	17,5x12,5	300	1
25783	22,20	21,7x15	700	1



## Cacerola oval con base

Faitout ovale avec basse · Oval Bratentopf mit Holzsockel  
Oval casserola with base · Caçarola oval com base

Ref	€	cm	ml	U.Venta
25881	16,00	15x10	200	4
25882	24,70	17,5x12,5	300	1
25883	27,40	21,7x15	700	1



## Mini plancha rectangular

Mini plaque grill lisse rectangulaire · Mini Platte Grill, glatt, rechteckiger  
Mini rectangular grill plaque flat · Mini plancha grill liso rectangular

Ref	€	cm	U.Venta
25774	10,50	17x10	4



## Mini plancha rectangular con base

Mini plaque Grill lisse rectang. a/basse · Mini Platte Grill, glatt, rechteckiger m/Holzsockel  
Mini rectangular grill plaque flat with base · Mini plancha grill liso rectangular c/base

Ref	€	cm	h(cm)	U.Venta
25874	15,40	17x10	2,5	4



## Mini plancha grill cuadrado

Mini plaque grill carré · Mini Platte Grill, Quadrat  
Mini square grill plaque · Mini plancha grill quadrado

Ref	€	cm	h(cm)	U.Venta
25775	11,00	14x14	1,7	4



## Mini grill

Mini grill · Mini Grill  
Mini grill · Mini grill

Ref	€	cm	h(cm)	U.Venta
25776	11,40	14x14	2,5	4



## Mini sartén lisa

Mini poêle lisse · Mini Pflanne  
Mini frying pan flat · Mini sertã lisa

Ref	€	Ø (cm)	h(cm)	U.Venta
25777	11,50	13	1,7	4



## Mini plancha grill cuadrado con base

Mini plaque grill carré avec basse · Mini Platte Grill, Quadrat mit Holzsockel  
Mini square grill plaque with base · Mini plancha grill quadrado com base

Ref	€	cm	h(cm)	U.Venta
25875	15,40	14x14	1,7	4



## Mini grill con base

Mini grill avec basse · Mini Grill mit Holzsockel  
Mini grill with base · Mini grill com base

Ref	€	cm	h(cm)	U.Venta
25876	17,80	14x14	2,5	1



## Mini sartén lisa con base

Mini poêle lisse avec basse · Mini Pflanne mit Holzsockel  
Mini frying pan flat with base · Mini sertã lisa com base

Ref	€	Ø (cm)	h(cm)	U.Venta
25877	16,50	13	1,7	1

Mango desmontable  
Removable handle

new



## Bandeja oval con mango y base

Plateau ovale avec manche et base · Ovale tablett mit griff und basis  
Oval tray with handle and base · Bandeja oval com cabo e base

Ref	€	cm	h (cm)	U.Venta
25867	18,10	24x14	2,2	1

# Magma Grey & Red



- Acabado exterior e interior esmaltado, muy resistente y de gran durabilidad.
- Muy versátil: ideal para cocinar asados, arroces, pasta, cocer a fuego lento e incluso hornear tartas dulces y pan.
- Conserva todos los nutrientes, vitaminas y sabores de los alimentos.
- Excelente retención y distribución uniforme del calor.
- Incluye base de madera, ideal para servir y presentar.
- Apta para todo tipo de fuegos.

- Finition émaillée extérieure et intérieure, très résistante et d'une grande durabilité.
- Très polyvalent: idéal pour cuisiner des rôtis, du riz, des pâtes, cuire à feu doux et même cuire des gâteaux sucrés et à pain.
- Gardez tous les nutriments, vitamines et saveurs des aliments.
- Excellente rétention et distribution uniforme de la chaleur.
- Comprend la base en bois, idéale pour servir et présenter.

- Convient à tous les types d'incendies.
- Exterior and interior enameled finish, very resistant and of great durability.
- Very versatile: Ideal for cooking roasts, rice, pasta, cook over low heat and even bake sweet and bread cakes.
- Keep all nutrients, vitamins and flavors of food.
- Excellent retention and uniform distribution of heat.
- Includes wood base, ideal to serve and present.
- Suitable for all types of fires.



## Cacerola redonda

Faitout rond · Rund Bratentopf  
Round casserole · Caçarola redonda

	Ref	€	Ø (cm)	h(cm)	ml	U.Venta
A	25841	18,10	12,0	3,0	200	1
	25848	28,10	16,2	3,0	470	1
	25849	34,80	18,5	3,0	720	1
B	25851	18,10	12,0	3,0	200	1
	25858	28,10	16,2	3,0	470	1
	25859	34,80	18,5	3,0	720	1

## Cacerola oval

Faitout ovale · Oval Bratentopf  
Oval casserole · Caçarola oval

	Ref	€	cm	h(cm)	ml	U.Venta
A	25842	24,10	17,5x12,5	3,0	250	1
	25840	34,70	21,7x15	3,0	700	1
	25852	24,30	17,5x12,5	3,0	250	1
B	25850	35,00	21,7x15	3,0	700	1



## Sartén

Poêle · Pfanne  
Frying pan · Sertä

	Ref	€	Ø (cm)	h(cm)	ml	U.Venta
A	25843	18,20	13,5	3,0	275	1
B	25853	18,20	13,5	3,0	275	1

## Cacerola oval con tapa

Faitout ovale avec couvercle · Oval Bratentopf mit Deckel  
Oval casserole with lid · Caçarola oval com tampa

	Ref	€	cm	h(cm)	ml	U.Venta
A	25847	34,70	13x10	5,0	400	1
B	25857	34,70	13x10	5,0	400	1



# Presentación



## Fuente 5 compartimentos Zensai

Plat 5 compartiments · Platte mit 5 Fächern  
5-compartment tray · Travessa com 5 compartimentos

Ref	€	Ø (cm)	h(cm)	Compart	U.Venta
61242	9,70	25,5	4,0	5	1



## Bandeja con cuencos Basic

Plateau avec bols · Tablett mit Schüsseln  
Tray with bowls · Bandeja com taças

	Ref	€	Base (cm)	Cuenco (cm)	ml
A	61240	7,50	28x10x1	100 (x3)	1
B	61241	7,50	28x10x1	90 (x3)	1
C	61243	22,30	Ø26x1	-	1



## Bandeja Olive

Plateau · Tablett  
Tray · Bandeja

Ref	€	cm	U.Venta
61244	4,80	19x9	1

## Set 3 ramequines

Ensemble de 3 ramequins · 3 kleine Auflaufformen  
Set of 3 ramekins · Conjunto de 3 ramequins

Ref	€	Ø (cm)	h(cm)	ml	U.Venta
61239	6,00	9	5	130	1



## Bandeja Share

Plateau · Tablett  
Tray · Bandeja

Ref	€	cm	h(cm)	U.Venta
61245	15,20	38,5x10	4,8	1



## Tabla mármol y bambú

Planche marbre & bambou · Marmor & bambusbrett  
Marble & bamboo board · Tábua mármore & bambu

Ref	€	Tabla (cm)	Mármol (cm)	Cuenco (cm)	ml	U.Venta
61040	18,70	28x28x1,5	24,5x15x1	Ø8x3	100 (x3)	1



## Tabla pizarra & bambú con cuencos

Planche ardoise & bambou · Schiefer & bambusbrett  
Tábua ardósia & bambu · Slate & bamboo board

Ref	€	Tabla (cm)	ml	U.Venta
61042	18,90	28x28x1,5	56	1

### Tabla pizarra & bambú

Planche ardoise & bambou · Schiefer & bambusbrett  
Slate & bamboo board · Tábua ardósia & bambu

	Ref	€	Tabla (cm)	Pizarra (cm)	U.Venta
<b>A</b>	61045	7,50	40x10x1,5	25x7,5	1
<b>B</b>	61046	15,00	50x18x1,5	35x15	4
<b>C</b>	61047	20,20	38,5x28x1,5	Ø25	12

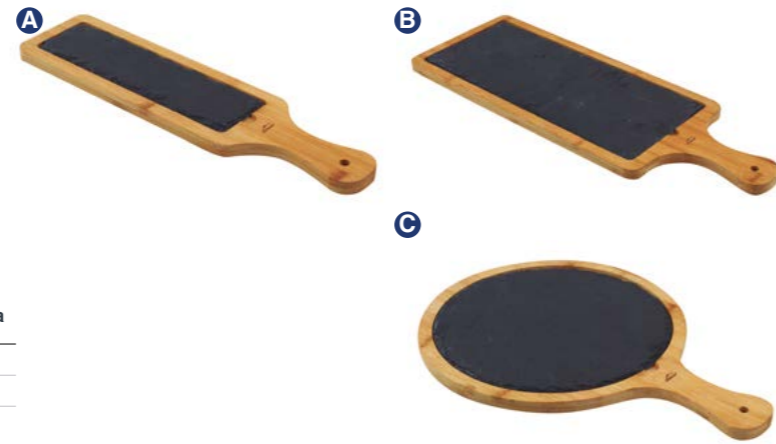

## Miniaturas y cestillos



Reversible  
Reversible

MF Melamine Stackable Dishwasher BPA free

### Soporte para tacos

Support de tacos · Tacos Unterstützung  
Tacos support · Suporte de tacos

	Ref	€	Tacos	cm	h(cm)	U.Venta
<b>A</b>	63281	4,10	1-2	12x6	4	1
<b>B</b>	63282	4,70	2-3	18x6	4	1
<b>C</b>	63283	5,60	3-4	23x6	4	1



ABEDUL Birch Dishwasher

### Mini pallet presentación

Mini palette de présentation · Minipalette für Präsentation  
Mini pallet for presentation · Mini palette de apresentação

	Ref	€	cm	h(cm)	U.Venta
	61060	6,70	13x8	3,0	1
	61059	8,90	20x12	3,0	1
	61058	11,90	30x20	3,0	1
	61057	13,70	40x15	3,0	1

Vitro Electric Gas Dishwasher ECO PFOA free

### Colección Smart

Plat à paella · Paellapfanne, emailliert  
Round dish for paelle · Paelheira esmaltada

	Ref	€	Ø (cm)	U.Venta
<b>A</b>	60170	5,20	10	1
	60172	5,90	12	1
	60175	6,90	15	1
	60180	8,80	20	1
<b>B</b>	60192	6,70	12	1
	60196	7,90	16	1
	60190	8,70	20	1



## INOX

### Mini cubo

Mini-cube · Mini-Eimer  
Mini cube · Mini cubo

	Ref	€	Ø (cm)	h(cm)	ml	U.Venta
<b>A</b>	61107	4,90	7	7,0	200	12
<b>B</b>	61109	5,90	9	9,0	340	1
<b>C</b>	61112	7,60	12	12,0	900	1



INOX Dishwasher

### Cestillo redondo

Panier rond · Korb, Rund  
Round basket · Cesta redonda

	Ref	€	Ø (cm)	h(cm)	U.Venta
<b>A</b>	61009	8,90	9	8,0	6
<b>B</b>	61069	8,90	9	8,0	6
<b>C</b>	61150	8,70	9	8,0	6



### Cestillo cuadrado

Panier carré · Korb, quadratisch  
Square basket · Cesta cuadrada

	Ref	€	cm	h(cm)	U.Venta
<b>A</b>	61007	8,90	10x8	7,0	6
	61052	11,50	12x10	9,0	6
<b>B</b>	61067	8,90	10x8	7,0	6
	61062	11,50	12x10	9,0	6
<b>C</b>	61151	8,70	10x8	7,0	6
	61152	11,20	12x10	9,0	6



### Cestillo cónico

Panier conique · Korb, Konisch  
Conical basket · Cesta cónica

	Ref	€	Ø (cm)	h(cm)	U.Venta
<b>A</b>	61053	9,90	12	10,0	6
<b>B</b>	61063	9,90	12	10,0	6
<b>C</b>	61153	9,60	12	10,0	6



### Cestillo rectangular

Panier rectangulaire · Korb, rechteckig  
Rectangular basket · Cesta rectangular

	Ref	€	cm	h(cm)	U.Venta
<b>A</b>	61056	13,40	21x11	6,0	1
<b>B</b>	61066	13,40	21x11	6,0	1
<b>C</b>	61155	12,90	21x11	6,0	1



### Cestillo rectangular con asas

Panier rectangulaire a/poignées · Korb, rechteckig mit Griffen  
Rectangular basket with handles · Cesta rectangular com alças

	Ref	€	cm	h(cm)	U.Venta
<b>A</b>	61055	13,40	21x11	6,0	1
<b>B</b>	61065	13,40	21x11	6,0	1
<b>C</b>	61154	12,90	21x11	6,0	1





# Paneras y fruteros



- Tapa fabricada en madera de caucho con orificios de ventilación para una óptima circulación del aire.
- 2 en 1: la tapa de madera de caucho se puede utilizar como tabla de cortar.

- Cover made of rubber wood with ventilation holes for optimal air circulation.
- 2 in 1: The rubber wood lid can be used as a cutting table.



RUBBER WOOD

## Panera nórdica

Boîte à pain · Brotkasten  
Bread basket · Caixa para guardar pão

Ref	€	cm	h(cm)	U.Venta
A 62868	39,60	30x18	12,5	1
B 62869	43,00	42x22,5	12,5	1



- Fabricada en fibra virgen natural.
- Material ecológico y respetuoso con el medio ambiente.
- Lavable, resistente y duradera.
- Diseñada y fabricada en España.
- Hecha a mano.
- Tacto agradable y suave, similar a la piel. Espesor 0,55 mm.

- Fabriqué en fibre vierge naturelle.
- Matériel écologique et environnemental.
- Lavable, résistant et durable.
- Conçu et fabriqué en Espagne.
- Fait main.
- Un toucher agréable et doux, similaire à la peau. 0,55 mm d'épaisseur.

- Manufactured in natural virgin fiber.
- Ecological and environmental material.
- Washable, resistant and lasting.
- Designed and manufactured in Spain.
- Handmade.
- Nice and soft touch, similar to the skin. 0.55 mm thickness.



INOX

## Frutero - Panera inox

Panier à fruit et à pain · Brot-/Obstschale  
Fruits and bread basket · Fruteiro-Cesto

Ref	€	Ø (cm)	U.Venta
61821	7,70	20	1
61823	11,60	24	1



## Panera kraft

Boîte à pain · Brotkasten  
Bread basket · Caixa para guardar pão

Ref	€	cm	h max (cm)	h min (cm)	U.Venta
A 63476	13,80	10x10	25	8	1
B 63477	14,70	12x12	25	12	1
C 63478	16,60	15x15	25	12	1
D 63479	19,20	20x20	33	12	1



## Panera Tex

Boîte à pain · Brotkasten  
Bread basket · Caixa para guardar pão

Ref	€	cm	h max (cm)	h min (cm)	U.Venta
A 63486	13,80	10x10	25	8	1
B 63487	14,70	12x12	25	12	1
C 63488	16,60	15x15	25	12	1
D 63489	19,20	20x20	33	12	1

Estructura de refuerzo de acero inoxidable  
Stainless steel reinforcement structure



## Cesta baguette

Corbeille · Brotkorb  
Basket · Cesta

Ref	€	A (cm)	B (cm)	C (cm)	D (cm)	E (cm)	U.Venta
A 63492	64,40	32,0	28,5	42,0	25,0	36,5	1
B 63493	64,40	32,0	28,5	42,0	25,0	36,5	1



## Cesta de pan redonda

Corbeille a pain ronde · Brotkorb, rund  
Round bread basket · Cesta de pão redonda

Ref	€	Ø (cm)	h(cm)	U.Venta
63471	7,90	19	8	1
A 63472	8,80	21	8	1
63473	9,40	23	8	1
63474	10,10	28	8	1
63871	8,00	19	8	1
B 63872	8,80	21	8	1
63873	9,40	23	8	1
63874	10,20	26	8	1

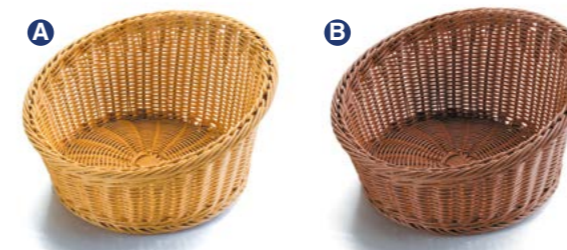

## Cesta de pan

Corbeille a pain · Brotkorb  
Bread basket · Cesta de pão

Ref	€	Ø (cm)	h (cm)	U.Venta
A 63494	30,80	35	20	1
B 63894	30,30	35	20	1



PP Polypropylene  
BPA free  
Stackable  
Dishwasher

- Cesta para pan fabricada en polipropileno. Diseñada para uso intensivo.
- Estructura de refuerzo de acero inoxidable. Parte trasera más alta que proporciona suficiente apoyo para panes largos.
- Material con aspecto de mimbre muy resistente, libre de BPA.
- Elaborada a mano. Práctica e higiénica. Acabado en mate.
- Ideal para almacenar y exponer panes.
- Apilable.

- Panier à pain fabriqué en polypropylène. Conçu pour une utilisation intensive.
- Structure d'armature en acier inoxydable. L'arrière le plus élevé qui fournit un soutien suicide aux pains longs.
- Matériau très résistant en osier, sans BPA.
- Fait main. Pratique et hygiénique. Finition mate.
- Idéal pour stocker et exposer le pain.
- Empilable.

- Bread basket manufactured in polypropylene. Designed for intensive use.
- Stainless steel reinforcement structure. Highest rear that provides suicide support for long breads.
- Very resistant wicker -like material, BPA free.
- Handmade. Practice and hygienic. Matte finish.
- Ideal to store and expose bread.
- Stackable.



## Cesta de pan oval

Corbeille a pain ovale · Brotkorb, Oval  
Oval bread basket · Cesta de pão oval

Ref	€	cm	h(cm)	U.Venta
63480	7,20	19x14	8,0	1
A 63481	8,50	24x17	8,0	1
63482	10,40	28x16	8,5	1
63880	7,20	19x14	8,0	1
B 63881	8,40	24x17	8,0	1
63882	10,40	28x16	8,5	1



## Cesta de pan cuadrada

Corbeille a pain carré · Brotkorb, viereckig  
Square bread basket · Cesta de pão quadrada

Ref	€	cm	h (cm)	U.Venta
A 63490	35,20	53x33,5	9	1
B 63890	34,90	53x33,5	9	1



- Diseño transpirable.
- Versátil: ideal para fruta, verdura, tarros de conservas, frutos secos, huevos, etc.

- The breathable design.
- Versatile: perfect for fruit, vegetables, canning jars, etc.

Medidas · Sizes  
19,5x17,5x7 cm

Medidas · Sizes  
29x18x8 cm



RUBBER WOOD  
FE  
Iron

### Frutero varillas Dual

Corbeille à fruits · Obstschale aus Gitterstäben  
Rod fruit bowl · Cesto de metal para fruta



Ref	€	Ø superior (cm)	Ø inferior (cm)	h(cm)	Diámetro varilla (mm)	U.Venta
61140	54,90	Ø40x10	Ø24x10	63	4	1

### Frutero Dual SQ

Corbeille à fruits · Obstkorb  
Fruit basket · Fruteira

Ref	€	cm	h(cm)	U.Venta
61124	19,30	29x18,5	33,5	4

Madera contrachapada color haya  
Plywood beech color



FE  
Iron

### Frutero varilla mango

Corbeille à fruits · Obstschale aus Gitterstäben  
Square fruit bowl · Cesto de metal para fruta

Ref	€	h (cm)	Diámetro varilla (mm)	U.Venta
<b>A</b> 61137	35,30	28	4	1
<b>B</b> 61138	35,30	29	4	1

Ideales para almacenar fruta, pan, verduras, huevos, etc.  
Can be used for storing fruit, bread, vegetables, eggs, etc.



FE  
Iron

### Frutero varillas

Corbeille à fruits · Obstschale aus Gitterstäben  
Square fruit bowl · Cesto de metal para fruta

Ref	€	Ø (cm)	h (cm)	Diámetro varilla (mm)	U.Venta
<b>A</b> 61126	23,50	23,5	25,5	4	2
<b>B</b> 61127	21,40	27,0	14,0	4	1
<b>C</b> 61128	22,60	34,0	9,5	4	1



Madera aglomerada  
Agglomerate wood



FE  
Iron

### Frutero varillas redondo bajo

Corbeille à fruits ronde basse · Obstschale aus Gitterstäben  
Round low rod fruit bowl · Cesto de metal para fruta redondo baixo

Ref	€	Diámetro varilla (mm)	Ø superior (cm)	Base (cm)	h(cm)	U.Venta
61139	40,80	4	39	31,3	7,6	1

# Mesa

INOX 18/10  
Dishwasher



### Legumbreira

Legumiere · Servierschüssel  
Vegetable dish · Legumeira

Ref	€	Ø (cm)	L	U.Venta
60812	25,50	22	2,0	1
60814	28,60	24	3,0	1
60818	37,60	28	4,5	1



### Sopera con base

Soupiere sur pied · Suppenschüssel mit Fussreif  
Soup-tureen with base · Sopeira com base

Ref	€	Ø (cm)	L	U.Venta
60823	32,80	22	2,00	1
60825	35,00	24	2,50	1
60829	43,10	28	4,00	1



### Tapa sopera

Couvercle soupiere · Deckel für Servierschüssel  
Soup-tureen lid · Tampa sopeira

Ref	€	Ø (cm)	U.Venta
60922	20,70	22	1
60924	23,00	24	1
60928	27,00	28	1



ASA  
Acrylic  
Dishwasher  
Oven  
BPA free

### Ensaladera redonda

Saladier ronde · Salatschüssel, rund  
Round salad bowl · Bacia de salada redonda

Ref	€	Ø (cm)	L	U.Venta
62394	12,70	25	4,0	1



INOX

### 6 boles pequenos

6 petit bols · 6 Schüsseln, klein  
Vegetable bowls set of 6 · 6 bacias pequenas

Ref	€	Ø (cm)	ml	U.Venta
14012	11,60	12	325	1



### Salsera Luxe con cuchara

Sauciere "Luxe" · Sauciere Luxe  
Gravy boat "Luxe" · Molheira "LUXE" com colher

Ref	€	ml	U.Venta
62424	24,30	200	1



### Salsera Aladino

Sauciere "Aladino" · Sauciere "Aladino"  
Gravy boat "Aladino" · Molheira "Aladino"

Ref	€	cm	ml	U.Venta
61409	9,80	13x6x8	90	1
61415	11,70	15,5x7,2x10	150	1
61424	15,80	19x8,5x12,5	240	1
61430	17,00	20x9,5x12,5	300	1



### Quesera parmesana con cuchara

Boite à fromage a/cuillère · Parmesanmenage mit Löffel  
Parmesan bowl with spoon · Queijeira parmesana c/ colher

Ref	€	Ø (cm)	ml	U.Venta
62970	32,20	9x5	200	1
* 62971	4,20	-	200	18

\* Recipiente de cristal · Glass container



### Fuente de mantequilla

Beurrier avec couvercle · Butterdose mit Deckel  
Butter dish with cover · Manteigueira

Ref	€	cm	h(cm)	U.Venta
62951	14,40	11,5x22,5	6,5	1

Área útil de la base:  
Base useful area:  
15x10,5 cm

BAMBOO VIDRIO  
Glass



### Recipiente mantequilla

Réceptacle pour le beurre · Butterdose  
Butter container · Recipiente para manteiga

Ref	€	cm	h(cm)	U.Venta
62898	10,10	18,5x14	6,5	1



PP  
Polypropylene  
RUBBER WOOD  
BPA free

### Recipiente mantequilla PP

Réceptacle pour le beurre · Butterdose  
Butter container · Recipiente para manteiga

Ref	€	cm	h(cm)	U.Venta
62899	15,40	16,5x11,5	6,5	1



**Campana cubreplatos Inox**  
Cloche couvre plat · Tellerlocke  
Plate Cover · Campânula cobre-pratos

Ref	€	Ø (cm)	h(cm)	U.Venta
69024	26,30	24	11,0	1
69029	39,50	28	17,5	1



**Campana cubreplatos PS**  
Cloche couvre plat · Tellerlocke  
Plate Cover · Campânula cobre-pratos

Ref	€	Ø (cm)	h(cm)	U.Venta
61806	40,50	25	18,5	1
61809	46,30	29	20,3	1
61802	50,10	33	22,3	1



**Campana cubreplatos PS**  
Cloche couvre plat · Tellerlocke  
Plate Cover · Campânula cobre-pratos

Ref	€	Ø (cm)	h(cm)	U.Venta
61801	6,70	22,0	12,0	1
61803	12,40	30,0	15,5	1



**Servilletero**  
Distributeur de serviettes · Serviettenspender  
Napkin holder · Guardanapo

Ref	€	cm	h(cm)	U.Venta
61004	13,90	18x19	5,0	1

INOX



**Servilletero bar**  
Distributeur de serviettes bar · Serviettenspender bar  
Bar napkin holder · Guardanapo bar

Ref	€	cm	Medidas Servilleta	U.Venta
61002	9,70	9,5x13,5	90x125	4



**Cubre quesos/tartas**  
Couvre fromage/gâteau · Tellerabdeckung  
Cheese/cake cover · Cloque para queijo/tartes

Ref	€	Ø (cm)	U.Venta
62380	55,10	32	1



**Quesera**  
Plateau à fromage avec cloche · Käseglocke  
Cheese dome · Queijeira

Ref	€	U.Venta
62404	29,80	1



**Quesera Keep**  
Plateau à fromage avec cloche · Käseglocke  
Cheese dome · Queijeira

Ref	€	cm	h(cm)	U.Venta
62004	26,00	28,5x18,5	10	1



INOX

**Campanilla de recepción**  
Sonnente de réception · Rezeptionsklingel  
Reception call bell · Campainha de receção

Ref	€	Ø (cm)	U.Venta
61025	11,60	10	1



**Papelerera sobremesa**  
Poubelle de table · Tish-Abfallbehälter  
Table bin · Papeleira de mesa

Ref	€	Ø (cm)	h(cm)	L	U.Venta
63302	24,80	12	16	1,20	1



**Azucarero sobremesa**  
Sucrier de table sphérique · Zuckerdose, Kugelförmig  
Spherical table sugar bowl · Açucareiro de mesa esférico

Ref	€	Ø (cm)	ml	U.Venta
63304	17,40	14	600	1



INOX

**Pinza sujeta manteles (4pcs.)**  
Pince à nappe · Tischclothklammer  
Tablecloths pegs · Pinça para toalhas de mesa

Ref	€	U.Venta
61023	7,10	6



INOX

**Número de mesa**  
Numéros de table · Tischnummernschild  
Table numbers · Números para tabela

Ref	€	cm	Números	U.Venta
61095	20,50	6x5	1-12	1
61096	20,50	6x5	13-24	1
61097	20,40	6x5	25-36	1



INOX

**Indicador reservado**  
Indicateur résevée · Reserviert-Aufsteller  
Reserved signal · Indicador reservado

Ref	€	cm	U.Venta
61098	4,40	5x12	6



**Soporte menú con pinza**  
Support menu à pince · Menükartenhalter  
Menu card holder · Suporte menú com pinça

Ref	€	h(cm)	U.Venta
61008	13,20	20,0	1
61012	14,80	30,0	1



INOX

**Cepillo recogemigas**  
Ramasse-miettes à rouleaux · Krümelbürste  
Crumbs cleaner · Escova apanha-migalhas

Ref	€	cm	h(cm)	U.Venta
64407	15,10	9,5x16,5	4,0	1



**Cepillo recogedor Hiperluxe**  
Ramasse-miettes à rouleaux · Krümelbürste  
Crumbs cleaner · Escova apanha-migalhas

Ref	€	cm	U.Venta
64408	51,10	14,5x17	1



**Cepillo recogedor Luxe**  
Ramasse-miettes · Krümelbürste  
Crumbs cleaner · Espátula apanha-migalhas

Ref	€	cm	U.Venta
64409	31,70	22x7	1



**Bandeja con pinza para notas**  
Porte addition à pince · Platte mit Klemmvorrichtung  
Bill holder · Bandeja com pinça para notas

Ref	€	cm	U.Venta
A 68007	5,40	11x15,2	12
B 68017	6,40	12x21,5	12



**Bandeja cambios Coin**  
Coupelle ramasse monnaie · Wechselgeldablagen  
Changetray · Bandeja para trocos

Ref	€	Ø (cm)	U.Venta
68720	3,20	13	12



**Cenicero**  
Cendrier · Aschenbecher  
Ashtray · Cinzeiro

Ref	€	Ø (cm)	U.Venta
A 14013	2,80	14	12
A 14065	3,20	16	12
B 62941	6,40	14	1

# Encendedores



new

- Encendedor de gas flexible y recargable.
- Ideal para las cocinas de gas, chimeneas o barbacoas.
- Regulador de llama. Sistema de bloqueo de seguridad.
- Ranura transparente, para controlar el nivel de carga.
- Protector anti viento.

- Flexible and refillable gas lighter.
- Ideal for gas cookers, fireplaces or barbecues.
- Flame regulator.
- Safety locking system.
- Transparent slot, to control the charge level.
- Anti-wind protector.



Llama · Flame

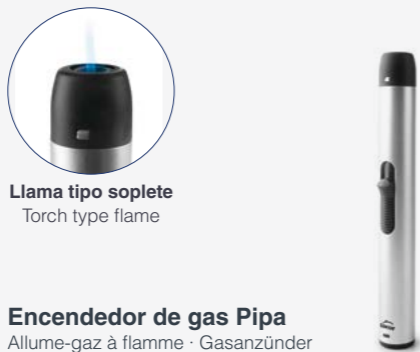

Llama tipo soplete  
Torch type flame

## Encendedor de gas Flex

Allume-gaz à flamme · Gasanzünder  
Gas lighter · Isqueiro de gás

Ref	€	Largo (cm)	U.Venta
68966	2,40	23,5	1

## Encendedor de gas Pipa

Allume-gaz à flamme · Gasanzünder  
Gas lighter · Isqueiro de gás

Ref	€	Largo (cm)	U.Venta
68967	3,40	16,0	1

- Encendedor eléctrico. Recargable con cable USB.
- Ideal para las cocinas de gas, barbacoas, etc.
- Funciona mediante una chispa entre los dos electrodos que hará encender el gas o las mechas.
- Indicador LED de nivel de carga.
- Autonomía: 50 usos con una sola carga.

- Electric lighter. Rechargeable with USB cable.
- Ideal for gas cookers, barbecues, etc.
- It works by means of a spark between the two electrodes that will ignite the gas or wicks.
- LED charge level indicator.
- Autonomy: 50 uses on a single charge.



Impulsos eléctricos  
Electrical impulses

## Encendedor de gas Chip

Allumeur électrique · Elektrisches Küchenfeuerzeug  
Electric lighter · Isqueiro elétrico

Ref	€	Largo (cm)	U.Venta
68959	11,70	18	1



## Encendedores de gas Spark

Allume-gaz à flamme · Gasanzünder  
Gas lighter · Isqueiro de gás

Ref	€	Largo (cm)	U.Venta
68987	4,10	27	6



## Encendedor de gas Fixed

Allume-gaz à flamme · Gasanzünder  
Gas lighter · Isqueiro de gás

Ref	€	Largo (cm)	U.Venta
68978	3,60	27	12



## Encendedor de gas Bend

Allume-gaz à flamme · Gasanzünder  
Gas lighter · Isqueiro de gás

Ref	€	Largo (cm)	U.Venta
68979	4,40	27	12

Caña flexible  
Flexible rod

## Caja encendedor de gas Fixed

Allume-gaz à flamme · Gasanzünder  
Gas lighter · Isqueiro de gás

Ref	€	Piezas	U.Venta
68976	37,80	12	1



12 units

## Caja encendedores de gas Bend

Allume-gaz à flamme · Gasanzünder  
Gas lighter · Isqueiro de gás

Ref	€	Piezas	U.Venta
68977	48,50	12	1



12 units



# Fondue collection

- Fondue eléctrica acabada en acero inoxidable de gran calidad.
- Ideal para fundir queso, chocolate o calentar aceite.
- Olla de acero inoxidable desmontable y de 1,2 L de capacidad con fondo termodifusor para una distribución uniforme del calor.
- Termostato regulable para calentar y mantener los ingredientes siempre calientes.
- Protector antisalpicaduras extraíble con soporte para 8 tenedores.
- Incluye 8 tenedores de acero inoxidable y marcas de colores.
- Apagado de seguridad contra sobrecalentamiento.
- Pies antideslizantes. 100% estable.
- Olla, protector y tenedores aptos para el lavavajillas.

- High quality stainless steel electric fondue set.
- Ideal for melting cheese, chocolate or heating oil.
- 1.2 L removable stainless steel pot with thermo-diffuser bottom for even heat distribution.
- Adjustable thermostat to heat and keep the ingredients hot at all times.
- Removable splash guard lid that holds 8 forks.
- Includes 8 stainless steel colour marked forks.
- Overheating safety function.
- Non-slip feet. 100% stable.
- Dishwasher safe pot, lid and forks.



- Fabricada en hierro fundido esmaltado de máxima calidad. Interior y exterior esmaltado que garantiza una distribución del calor uniforme sin puntos de sobrecalentamiento.
- No absorbe la humedad, los sabores, ni los olores de los alimentos.
- Diseñada para preparar deliciosas fondues de chocolate, queso, verduras, carne, etc.
- Cuenta con protección contra las salpicaduras, soporte de hierro colado y base de madera para mayor estabilidad. Además, incluye quemador de gel combustible (gel no incluido).
- La olla tiene 16,5 cm de diámetro y una capacidad de 1,2 L.
- Apta para todas las fuentes de calor, incluida la inducción.

- Manufactured in molten Iron enameled of the highest quality. Interior and outdoor enameled that guarantees a distribution of uniform heat without overheating points.
- It does not absorb moisture, flavors, nor the smells of food.
- Designed to prepare delicious chocolate fondues, cheese, vegetables, meat, etc.
- It has protection against splashes, cast iron support and wood base for greater stability. In addition, it includes fuel gel burner (gel not included).
- The pot is 16.5 cm in diameter and a capacity of 1.2 L.
- Suitable for all heat sources, including induction.



INOX 18/10 CE

## Fondue Grey Plus

Fondue · Fondue  
Fondue · Fonduel

Ref	€	W	Temperatura	L	U.Venta
69399	101,90	1500	40°C - 95°C	1,20	1



FE Iron  
FUNDIDO Cast  
Dishwasher

## Fondue Rosso

Fondue · Fondue  
Fondue · Fonduel

Ref	€	L	U.Venta
71711	63,90	1,20	1



## Gel combustible Etanol

Gel chauffe ETHANOL · Brennpaste, ETHALKOHOL  
Fuel gel, ETHANOL · Gel combustible ETANOL

	Ref	€	Peso (Kg)	Horas	U.Venta
A	71780	4,90	0,08	80 min	1
B	69108	2,80	0,225	3	72
C	69107	8,80	0,840	-	1
D	69109	40,50	4,00	-	1



# Aliño

INOX  Dishwasher



**Juego vinagrera Basic**  
Set vinaigrie · Menage  
Cruet set · Jogo galheteiro

Ref	€	ml	U.Venta
62864	14,30	175-37,5	1



**Juego aceitera-vinagrera Basic**  
Set huilier et vinaigries · Öl-Essig-Set  
Oil-vinegar set · Jogo azeiteira-galheteiro

Ref	€	ml	U.Venta
62862	11,40	175	1



**Juego salero-pimentero Basic**  
Set calière et poivriere · Satz-Pfeffer-Set  
Salt-pepper set · Jogo saleiro-pimenteiro

Ref	€	ml	U.Venta
62866	5,90	37,5	6



**Juego salero-pimentero-mostaza Basic**  
Set 3 pièces sel poivre moutarde · Salz/Pfeffer/Senf-Set  
Salt-pepper-mustard set · Saleiro-pimenteiro-mostarda set

Ref	€	ml	U.Venta
62867	9,40	37,5-150	1



INOX 18/10

**Aceitera cónica**  
Huilier · Ölkanne  
Oil can · Azeiteira cónica

Ref	€	h(cm)	L	U.Venta
62525	28,80	10,0	0,25	1
62555	42,20	19,0	0,50	1
62551	51,90	23,0	1,00	1



**Dosificador-medidor de aceite**  
Doseur distributeur à huile · Öl-Dosierer mit Massanzeige  
Oil portionner-measurer · Distribuidor-manómetro de óleo

Ref	€	Ø (cm)	ml	U.Venta
62252	22,70	7,8x23	250	1



PC Polycarbonate 

**Pulverizador de aceite**  
Pulvérisateur d'huile · Öl-Spray  
Oil Sprayer · Pulverizador de azeite

Ref	€	Ø (cm)	ml	U.Venta
61908	15,80	7x18	100	1



ASA Acrylic 

**Pulverizador de aceite-vinagre**  
Pulvérisateur d'huile et vinaigries · Öl-Essig Spray  
Oil-vinager bottle spray · Pulverizador de azeite-galheteiro

Ref	€	Ø (cm)	ml	U.Venta
61921	16,50	5,5x20	200	1



**Filtro resistente al calor**  
Heat-resitant filter

PS Plastic 

**Jarra separadora grasas**  
Separateur de graisse · Fettabscheider  
Gravy/fat separator · Separador de gorduras

Ref	€	ml	Unidad	U.Venta
61610	7,30	500	ml-oz-cup	4

# Especieros

INOX 



**Especiero agujeros Inox**  
Saupoudreuse à figures · Gewürzdose/Streuer, Lochung  
Shaker plastic cover hole lid · Polvilhador burucos

Ref	€	Ø (cm)	h (cm)	U.Venta
A 62906	8,90	7	9,5	12
B 62905	8,90	7	9,5	12



**Especiero queso Inox**  
Saupoudreuse à fromage · Käsestreuert  
Cheese shaker · Polvilhadoqueijo ralado

Ref	€	Ø (cm)	h (cm)	U.Venta
62904	8,70	7	9,50	12



**Especiero malla Inox**  
Saupoudreuse à maille · Gewürzdose/Streuer-Fein  
Shaker plastic cover fine mesh lid · Polvilhador rede fina

Ref	€	Ø (cm)	h (cm)	U.Venta
62903	9,40	7	9,50	12

PMMA Plastic  INOX 18/10  





**Pimentero Clear**  
Poivrière · Pfefferstreuer  
Pepper shaker · Pimenteiro

Ref	€	Ø (cm)	h (cm)	U.Venta
61903	10,90	7	12,5	1



**Especiero queso Clear**  
Saupoudreuse à fromage · Käsestreuert  
Cheese shaker · Polvilhadoqueijo ralado

Ref	€	Ø (cm)	h (cm)	U.Venta
61905	10,90	7	12,5	1



**Salero Clear**  
Salière · Salzstreuet  
Salt shaker · Saleiro

Ref	€	Ø (cm)	h (cm)	U.Venta
61907	11,00	7	12,5	1



**Azucarero Clear**  
Saupoudreuse à sucre · Zuckerstreuert  
Sugar shaker · Acucareiro

Ref	€	Ø (cm)	h (cm)	U.Venta
61904	12,30	7	12,5	1



**Especiero malla Clear**  
Saupoudreuse à maille fine · Mehlstreuer  
Mesh shaker · Polvilhador rede

Ref	€	Ø (cm)	h (cm)	U.Venta
61906	11,60	7	12,5	1



**Dispensador miel Clear**  
Distributeur de miel · Honigbehälter  
Honey dispenser · Dosificador mel

Ref	€	Ø (cm)	h (cm)	U.Venta
61909	14,40	7	12,5	1

# Molinillos



new



- Fabricados en madera de caucho de alta calidad con un revestimiento de esmalte mate natural.
- Muela de cerámica eficaz, de gran durabilidad y resistente a la corrosión.
- Pomo ajustable de molienda fabricado en acero inoxidable.
- Diseño clásico y elegante, dirigidos tanto para el usuario profesional como para el doméstico.
- Ergonómicos y versátiles: aptos para sal, pimienta y otras especias.

- Fabriquée en bois de caoutchouc de haute qualité avec un revêtement en vernis mat naturel.
- Meule en céramique efficace, très durable et résistante à la corrosion.
- Bouton de meulage réglable en acier inoxydable.
- Conception classique et élégante, destinée aux professionnels et aux particuliers.
- Ergonomiques et polyvalent : apte pour le sel, le poivre et d'autres épices.

- Made of high quality rubber wood with a natural matt enamel coating.
- Effective, highly durable and corrosion-resistant ceramic grinding wheel.
- Adjustable grinding knob made of stainless steel.
- Classic and elegant design, suitable for both professional and home users.
- Ergonomic and versatile: suitable for salt, pepper and other spices.

**Mecanismo cerámico**  
Ceramic mechanism

**Mecanismo cerámico**  
Ceramic mechanism

RUBBER WOOD CE INOX  
Ceramic



**Molinillo Black**  
Moulin · Manuelle  
Grinder · Moinho

Ref	€	h(cm)	U.Venta
64515	21,70	15	1
64520	27,20	20	1
64530	42,30	30	1

RUBBER WOOD CE INOX  
Ceramic



**Molinillo Wood**  
Moulin · Manuelle  
Grinder · Moinho

Ref	€	h(cm)	U.Venta
64815	18,50	15	1
64820	23,10	20	1
64830	37,10	30	1

**Mecanismo de acero templado**  
Hardened steel mechanism



HAYA  
Wood

**Mecanismo cerámico**  
Ceramic mechanism



ASA  
Acrylic

**Molinillo pimienta**  
Moulin à Poivre · Pfeffermühle  
Pepper Grinder · Moinho de pimenta em madeira

Ref	€	Ø (cm)	h(cm)	U.Venta
63215	27,40	5,0	15	1
63220	32,20	5,5	20	1
63225	38,20	6,0	25	1

**Molinillo de sal-pimienta**  
Moulin à sel - poivre · Pfeffer / Salz mühle  
Salt - pepper Grinder · Moinho de sal - pimenta

Ref	€	h(cm)	U.Venta
62814	24,10	14	6
62818	25,10	18	6
62823	27,10	23	6

**Mecanismo cerámico**  
Ceramic mechanism



ASA  
Acrylic

**Molinillo doble sal-pimienta**  
Moulin double à sel - poivre · Salz und Pfeffermühle Doppelt  
Salt - pepper double grinder · Moinho duplo de sal - pimenta

Ref	€	Ø (cm)	h(cm)	U.Venta
62816	20,00	6	18	1

2 in 1



CRISTAL INOX  
Glass 18/10

**Molinillo manual**

Moulin manuel · Manuelle Mühle  
Manual grinder · Moinho manual

Ref	€	Capacidad contenedor	U.Venta
62817	34,10	45 g	1



INOX CE BPA free Dishwasher

**Molinillo Limu**

Moulin à café · Kaffeemühle  
Coffe grinder · Moedor de café

Ref	€	W	Capacidad contenedor	U.Venta
69385	38,20	200	60 g	1



8 niveles de grosor  
8 grinding levels



**Mecanismo cerámico**  
Ceramic mechanism



- Ideal para moler café y otros alimentos como semillas, hierbas, frutos secos, cereales, sal, pimienta o especias.
- Muele al instante. Muelas cerámicas extrafuertes: no pierden filo y no se oxidan.
- Molido a baja velocidad: conserva mejor las propiedades y aromas.
- Funcionamiento sencillo. Muy fácil de limpiar.
- 8 niveles de grosor: obtén la molienda perfecta para ocasión.
- Depósito para 45 g de granos de café molido.

- Ideal for grinding coffee and other foods such as seeds, herbs, nuts, cereals, salt, pepper or spices.
- Move instantly. Extrafuertes ceramic teeth: do not lose edge and do not oxidize.
- Low speed: Better preserves properties and aromas.
- Simple operation. Very easy to clean.
- 8 thickness levels: get the perfect grinding for occasion.
- Deposit for 45 g of ground coffee beans.

- Ideal para moler café y otros productos como semillas, hierbas, frutos secos, cereales, sal, pimienta o especias.
- 100% acero inoxidable: cuerpo y cuchillas fabricados en acero inoxidable de máxima calidad.
- Tapa transparente: tapa superior de color transparente para visualizar el grano molido.
- Interruptor ON/OFF: funcionamiento con un simple botón (inicio/parada).
- Interruptor de seguridad: las cuchillas se activan solo cuando la tapa está correctamente cerrada.
- Depósito para 60 g de granos de café molido. Almacenamiento para el cable.

- Idéal pour le café et d'autres produits tels que les graines, les herbes, les noix, les céréales, le sel, le poivre ou les épices.
- 100% en acier inoxydable: corps et lames en acier inoxydable de qualité maximale.
- Couvercle transparent: couvercle de couleur transparente supérieure pour afficher le grain moulu.
- Interrupteur ON / OFF: Fonctionnement avec un bouton simple (démarrage / arrêt).
- Interrupteur de sécurité: les lames ne sont activées que lorsque le couvercle est correctement fermé.
- Déposez 60 g de grains de café moulus. Stockage du câble.

- Ideal for grinding coffee and other products such as seeds, herbs, nuts, cereals, salt, pepper or spices.
- 100% stainless steel: body and blades made of maximum quality stainless steel.
- Transparent lid: upper transparent color lid to display the ground grain.
- On/off switch: operation with a simple button (start/stop).
- Safety switch: The blades are activated only when the lid is correctly closed.
- Deposit for 60 g of ground coffee beans. Cable storage..



# Pinzas

INOX  
18/10  
Dishwasher



## Pinza servicio mesa

Pince à servir · Servierzange  
Serving tong · Pinça de serviço de mesa

Ref	€	Largo (cm)	U.Venta
62307	4,90	21	12



## Tenedor - Cucharar servir

Pince à service · Servierzange  
Utility tong · Garfo e colher de servir

Ref	€	Largo (cm)	U.Venta
68009	10,20	24	6



## Cuchara pinza servir

Cuillère pince à service · Servierlöffel, Zange  
Serving spoon tong · Concha pinça de servir

Ref	€	Largo (cm)	U.Venta
62353	12,50	24	1



## Pinza hamburguesa

Pince inox pour hamburger · Zange für Burgers  
Tongs for beef Burgers · Pinça de hamburger

Ref	€	Largo (cm)	U.Venta
62318	12,20	24	12



## Pinza pasta Luxe

Pince à spaghetti · Teigwaren Zange  
Pasta Tong · Pinça massas

Ref	€	Largo (cm)	U.Venta
62981	10,40	20	1



## Pinza pasta

Pince à spaghetti · Teigwaren-Zange  
Spaguetti Tong · Pinça massas

Ref	€	Largo (cm)	U.Venta
62986	5,60	19	12



## Pinza pan Small

Pince à pain · Brotzange  
Bread tong · Pinça pão

Ref	€	Largo (cm)	U.Venta
62978	9,00	18	1



## Pinza pan Medium

Pince à pain · Brotzange  
Bread tong · Pinça pão

Ref	€	Largo (cm)	U.Venta
62982	17,40	23	12



## Pinza ensalada

Pinces a salade · Salatzege  
Salad scissor tong · Pinça de salada

Ref	€	Largo (cm)	U.Venta
68021	4,90	28,5	12



ASA  
Acrylic  
BPA free

## Tenedor + cuchara ensalada

Fourchette + cuillère a salade · Gabel + Löffel Acryl  
Salad spoon + fork · Garfo + colher de salada

Ref	€	Largo (cm)	U.Venta
62399	7,80	30	1



## Pinza repostería

Pince à gateau · Gebäck-Tortenzange  
Cake tong · Pinça pastelaria

Ref	€	Largo (cm)	U.Venta
62317	12,00	20	1



## Pinza repostería con anillas

Pince à gateau avec anneaux · Gebäckzange  
Cake tong with rings · Pinça pastelaria com anilhas

Ref	€	Largo (cm)	U.Venta
68008	6,10	16	6

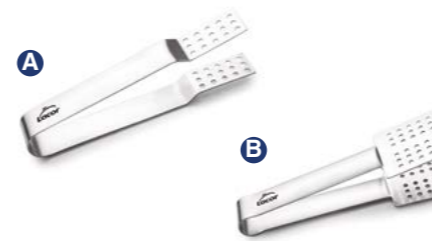

## Pinza para bolsitas de té

Pince pour sachets de thé · Teebeutelzange  
Tea bag tong · Pinças para saquetas de chá

Ref	€	Largo (cm)	U.Venta
A 68078	2,40	13,5	1
B 68079	3,60	14	1



## Pinza azucarillos

Pince à sucre · Zucker-Zange  
Food tong · Pinça p/cubos de açúcar

Ref	€	Largo (cm)	U.Venta
62985	3,80	11	6



## Pinza hielo

Pince à glace · Eiszange  
Ice tong · Pinça de gelo

Ref	€	Largo (cm)	U.Venta
62306	4,70	18,5	12



INOX

## Pinza hielo inox

Pince à glace · Eiszange  
Ice tong · Pinça de gelo

Ref	€	Largo (cm)	U.Venta
62337	10,20	20	12



## Pinza multiusos Luxe

Pince multi-usages · Allzweck Zange  
Multipurpose tong · Pinça multiusos

Ref	€	Largo (cm)	U.Venta
62334	20,30	25	1



INOX

## Pinza multiusos

Pince multi-usages · Allzweck-Zange  
Luxe tong · Pinça multiusos

Ref	€	Largo (cm)	U.Venta
62984	3,90	16	5



## Pinza Luxe

Pince · Zange  
Tong · Pinça

Ref	€	Largo (cm)	U.Venta
62983	15,70	30	12



SI  
Silicone  
BPA free  
200°C  
Max

## Pinza grill Red

Pince à grill · Grillzange  
Grill tong · Pinça grelhador

Ref	€	Largo (cm)	U.Venta
62931	9,20	29	1



INOX

## Pinza Jumbo

Pince de service · Zange  
Utility tong · Pinça

Ref	€	Largo (cm)	U.Venta
62924	5,90	24	12
62930	6,90	30	12
62940	8,10	40	12

INOX PA  
Nylon



**Pinza Jumbo Nylon**  
Pince de service · Zange  
Utility tong · Pinça

Ref	€	Largo (cm)	U.Venta
62926	7,60	24	12
62929	8,80	30	12
62939	11,40	40	12

INOX SI  
Silicone



**Pinza Jumbo Silicona**  
Pince de service · Zange  
Utility tong · Pinça

Ref	€	Largo (cm)	U.Venta
63926	7,60	24	12
63929	8,80	30	12
63939	11,40	40	12

2 in 1



INOX 18/10 PP PA  
Polypropylene Nylon



**Pinza Duplo**  
Pince · Zange  
Tong · Pinça

Ref	€	Largo (cm)	U.Venta
63049	11,90	30	1

INOX SI  
Silicone

**Pinzas Silicona**  
Pinces silicon · Silikon Zanges  
Silicone tongs · Pinças silicone

Ref	€	Largo (cm)	U.Venta
A 64434	69,30	18,0	1
B 64432	3,00	18,0	12
C 64433	3,00	18,0	12
D 64436	3,00	18,0	12
E 64437	3,00	18,0	12
F 64439	3,00	18,0	12



INOX BPA free

**Pinzas Karu**  
Pinces · Zanges  
Tongs · Pinças

Ref	€	Largo (cm)	Ref	€	Largo (cm)	U.Venta
A 63060	7,50	24	63070	8,10	30	12
B 63061	7,50	24	63071	8,10	30	12
C 63062	7,50	24	63072	8,10	30	12
D 63063	7,50	24	63073	8,10	30	12
E 63064	7,50	24	63074	8,10	30	12
F 63065	7,50	24	63075	8,10	30	12

Mango revestido con una capa de aislante térmica para una mejor sujeción.  
Handle coated with a layer of thermal insulation and an enhanced grip.



## Pinzas de precisión

INOX 18/10  
Dishwasher

- Pinza de precisión fabricada en acero inoxidable 18/10 de máxima calidad.
- Ideal para manipular y emplatar tus creaciones a la perfección.
- Mango antideslizante y puntas acanaladas para una sujeción 100% segura.
- Apta para el lavavajillas.

- Pince de précision en acier inoxydable 18/10 de qualité maximale.
- Idéal pour manipuler et placer parfaitement vos créations.
- Mango sans glissement et conseils châtés pour un soutien à 100% sûr.
- Convient au lave-vaisselle.

- Precision clamp made of stainless steel 18/10 of maximum quality.
- Ideal to manipulate and place your creations perfectly.
- Non-slip mango and chasted tips for 100% safe support.
- Suitable for dishwasher.

Puntas curvas puntiagudas y rugosas  
Curved tipspointed and rough



**Pinza de precisión recta**  
Pince à grill · Grilltange  
Grill tong · Pinça grelhador

Ref	€	Largo (cm)	U.Venta
62955	5,40	15,5	1
62956	10,60	21,0	1
62933	15,40	30,0	6

**Pinza de precisión acodada**  
Pince de précision · Präzision zange  
Precision tong · Pinça de precisão

Ref	€	Largo (cm)	U.Venta
62865	4,80	15,5	1

**Pinza de precisión Inox**  
Pince de précision · Präzision zange  
Precision tong · Pinça de precisão

Ref	€	Largo (cm)	U.Venta
62954	5,40	16	1
62821	6,40	21	1

Acabado negro mate  
Finish in matte black



Acabado iridiscente  
Iridescent finish



**Pinza de precisión Titan Black**  
Pince de précision · Präzision zange  
Precision tong · Pinça de precisão

Ref	€	Largo (cm)	U.Venta
62874	4,60	16	1
62872	6,10	21	1

**Pinza de precisión Titan Rainbow**  
Pince de précision · Präzision zange  
Precision tong · Pinça de precisão

Ref	€	Largo (cm)	U.Venta
62875	4,60	16	1
62873	6,10	21	1

**Pinza de precisión con cuchara**  
Pince de précision a/cuillère · Präzision zange m/Löffel  
Precision tong with spoon · Pinça de precisão c/colher

Ref	€	Largo (cm)	U.Venta
62863	6,00	17,0	1



# Utensilios cocina

INOX  
18/10



## Cuchara para miel

Cuillère à miel · Honiglöffel aus Edelstahl  
St steel honey spoon · Colher para mel

Ref	€	Largo (cm)	U.Venta
61361	10,90	16,5	1

ZAMAK  
Zinc Alloy



## Tenaza extractor huesos aceitunas

Dénoyateur, Chromé · Olivenentsteiner, Verchromt  
Zinc alloy live seed remover · Tenaz extrator de ossos de azeitonas

Ref	€	Largo (cm)	U.Venta
62973	8,20	16	1

6  
units



INOX

## Pinchos para marisco

Curettes à homard · Hummergabel  
Seafood forks · Espetos para marisco

Ref	€	Largo (cm)	U.Venta
62976	30,70	20,0	1

INOX



## Desescamador de pescado Mini

Grattoir de poissons · Fischeschuppenentferner  
Fish scraper · Raspador de peixe

Ref	€	Largo (cm)	U.Venta
39040	8,40	19	1



## Cascanueces Wood

Casse Noix · Nussknacker  
Nut Cracker · Parte-nozes

Ref	€	U.Venta
63059	8,20	1

- Fabricado en aleación de aluminio y mango de madera de acacia de gran calidad.
- Muelle de alta resistencia. Gracias a su diseño de alicata, la parte interior de la nuez no se rompe.
- 2 en 1: cascanueces y abridor de botellas.
- Mango ergonómico: fácil uso y sin apenas esfuerzo.
- Gran durabilidad.

new

- Fabriqu  en alliage d'aluminium et manche en bois d'acacia de grande qualit .
- Ressort hautement r sistant. Gr ce   sa conception en forme de tenailles, la partie int rieure de la noix ne se casse pas.
- 2 en 1 : casse-noix et ouvre-bouteilles.
- Manche ergonomique : utilisation simple et sans   peine d'efforts.
- Grande durabilit .
- Made of aluminium alloy with a high quality acacia wood handle.
- High resistance spring. The plier-like design prevents the kernel of the nut from breaking.
- 2 in 1: nutcracker and bottle opener.
- Ergonomic handle: easy and almost effortless to use.
- Long-lasting durability.



## Desescamador de pescado

Grattoir de poissons · Fischeschuppenentferner  
Fish scraper · Raspador de peixe

Ref	€	Largo (cm)	U.Venta
39041	12,10	27,5	1

## Doble hojas dentadas

Double toothed slats



Las escamas se quedan atrapadas en la funda  
The scales get trapped in the cover

INOX  
18/10  
SI  
Silicone

## Desescamador de pescado Safe

Grattoir de poissons · Fischeschuppenentferner  
Fish scraper · Raspador de peixe

Ref	€	Largo (cm)	U.Venta
39042	24,70	30	1
A R39042A	8,10	14	1

ZAMAK  
Zinc Alloy



## Cascanueces Basic

Casse Noix · Nussknacker  
Nut Cracker · Parte-nozes

Ref	€	Largo (cm)	U.Venta
63016	15,80	17	6

ZAMAK  
Zinc Alloy



## Cascanueces

Casse Noix · Nussknacker  
Nut Cracker · Parte-nozes

Ref	€	U.Venta
63017	19,80	6

3 in 1

INOX



## Tenaza marisco

Pince   casse-homard · Hummerzange  
Lobster cracker · Tenaz mariscos

Ref	€	Largo (cm)	U.Venta
62908	15,90	16	12

INOX



## Tijera-tenaza marisco

Pince casse homard · Schere/Zange Meeresfr chte  
Sea food scissor-tong · Tesoura-tenaz marisco

Ref	€	Largo (cm)	U.Venta
62974	17,60	18,5	12

## Abre ostras Luxe

Couteau   hu tres · Austermesser  
Oyster opener · Aberto-ostras

Ref	€	Largo (cm)	U.Venta
62684	12,90	20	1

# Manteles y salvamanteles

## Tablecloths and placemats



## Manteles de mesa



- Fabricado en cuero 100% reciclado. Espesor de 1,5 y 2,1 mm.
- Resistente a altas temperaturas y manchas. Aislante del calor. Impermeable.
- Perfecto para vestir y proteger las mesas de restaurantes, cafeterías y hasta el propio hogar.

- Fabriqué en cuir 100% recyclé. 1,5 et 2,1 mm d'épaisseur.
- Résistant aux températures et taches élevées. Isolateur de chaleur. Imperméable.
- Parfait pour s'habiller et protéger les tables des restaurants, des cafés et même de la maison.

- Made of 100% recycled leather. 1.5 and 2.1 mm thickness.
- Resistant to high temperatures and spots. Heat insulator. Raincoat.
- Perfect to dress and protect the tables of restaurants, coffee shops and even home.

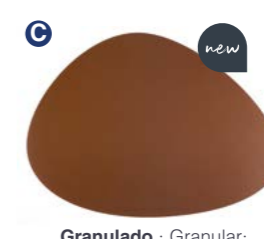

### Mantel individual Oval

Nappe individuelle ovale · Tischset, oval  
Oval individual placemat · Toalhas de mesa individual oval

Ref	€	cm	e (mm)	U.Venta
<b>A</b> 66845	20,40	45x35	1,6	1
<b>B</b> 66846	20,40	45x35	1,6	1
<b>C</b> 66847	20,40	45x35	1,6	1
<b>D</b> 66839	20,40	45x35	1,5	1
<b>E</b> 66840	20,40	45x35	1,5	1
<b>F</b> 66841	21,30	45x35	2,1	1
<b>G</b> 66842	21,30	45x35	2,1	1

- SAURA
- BOSCO
- SIMONE
- MILOS
- CRETA
- RINIA
- COS

### Mantel individual rectangular

Nappe individual rectangulaire · Tischset, rechteckiger  
Rectangular individual placemat · Toalhas de mesa individual rectangular

	Ref	€	cm	e (mm)	U.Venta	
<b>A</b>	66831	18,80	45x30	1,5	1	MILOS
<b>B</b>	66834	19,50	45x30	2,1	1	COS

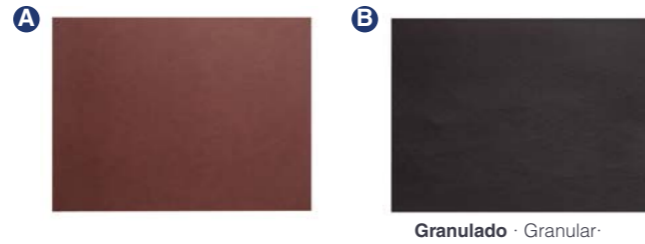

Granulado · Granular



### Mantel individual Home

Nappe individuel · Tischset  
Individual placemat · Toalha de mesa individual

	Ref	€	cm	U.Venta	
<b>A</b>	66756	4,40	45x30	6	KRABI
<b>B</b>	66757	4,40	45x30	6	TAPU
<b>C</b>	66772	4,90	45x30	6	LANTA
<b>D</b>	66773	4,90	45x30	6	KOTAO
<b>E</b>	66780	4,80	45x30	6	SUMBA
<b>F</b>	66781	4,80	45x30	6	BIAK
<b>G</b>	66782	4,80	45x30	6	GILI
<b>H</b>	66783	4,80	45x30	6	RINCA

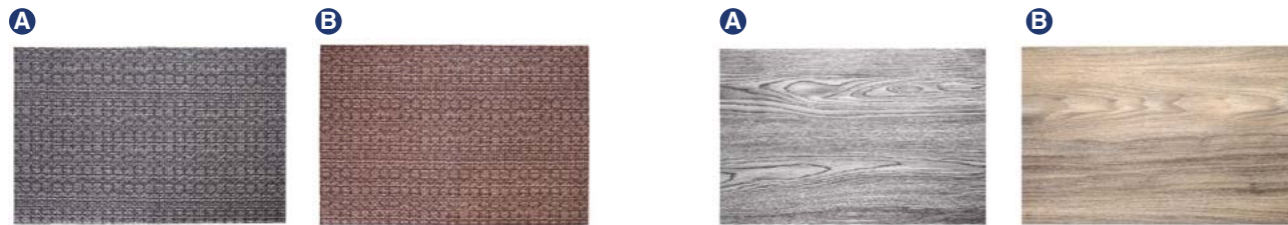

PVC  
Plastic

PVC  
Plastic

### Mantel individual Aura

Nappe individuel · Tischset  
Individual placemat · Toalha de mesa individual

	Ref	€	cm	U.Venta	
<b>A</b>	66784	7,10	45x30	6	MASBATE
<b>B</b>	66785	7,10	45x30	6	LEYTE

### Mantel individual Wood

Nappe individuel · Tischset  
Individual placemat · Toalha de mesa individual

	Ref	€	cm	U.Venta	
<b>A</b>	66787	7,10	45x30	6	DAVAO
<b>B</b>	66788	7,10	45x30	6	TICAO

# Salvamanteles



- **Salvamantel magnético fabricado en roble de máxima calidad, muy agradable al tacto (63041).**
- **Salvamantel magnético fabricado en silicona de máxima calidad (63042).**
- **Diseñado para apoyar y transportar sartenes, ollas, cacerolas, etc. de forma cómoda y segura, sin riesgo a quemarse.**
- **Superresistente a altas temperaturas. Protege las superficies y las encimeras.**
- **No es apto para el lavavajillas.**

- Dessous de plat magnétique fabriqué en chêne de la plus grande qualité, très agréable au toucher (63041).
- Dessous de plat magnétique fabriqué en en silicone de qualité supérieure (63042).
- Conçu pour transporter et y poser des poêles, des casseroles, des faitouts, etc. de façon pratique et sûre, sans risquer de se brûler.
- Très résistant aux hautes températures. Protège les surfaces et les plans de travail.

- Ne peut pas être mis au lave-vaisselle.
- Magnetic trivet made of top quality oak with a very nice feel (63041).
- Magnetic trivet made of top quality silicone (63042).
- Designed to hold and move frying pans, pots, casseroles etc. safely and conveniently without risk of getting burned.
- Extremely resistant to high temperatures. Protects surfaces and counter tops.
- Not dishwasher safe.



ROBLE  
Oak

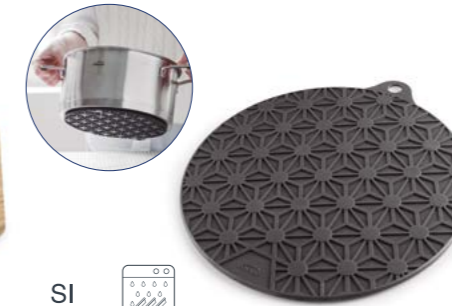

SI  
Silicone  
Dishwasher



SI  
Silicone  
Dishwasher

### Salvamanteles magnético

Dessous de plat magnétique · Untersetzer, magnetisch  
Magnetic trivet · Base para tachos magnética

Ref	€	cm	U.Venta
63041	21,80	23x20	1

### Salvamanteles magnético Grip

Dessous de plat magnétique · Untersetzer, magnetisch  
Magnetic trivet · Base para tachos magnética

Ref	€	Ø (cm)	U.Venta
63042	8,50	20	1

### Salvamanteles Unite

Dessous de plat · Untersetzer  
Trivet protector · Protector de toalhas

Ref	€	cm	U.Venta
63043	4,20	16x16	1

Cerrado · closed  
12,5x12,5 cm



INOX  
SI  
Silicone



INOX  
18/10



INOX

### Salvamanteles desplegable

Dessous de plats dépliant · Untersatz  
Trivet foldable · Protector de toalhas dobrável

Ref	€	cm	U.Venta
66752	11,40	16x16	1

### Salvamanteles

Dessous de plats · Untersatz  
Trivet protector · Protector de toalhas

Ref	€	cm	U.Venta
63008	18,90	23x23	1

FE  
Iron



### Salvamanteles Black

Dessous de plats · Untersatz  
Trivet protector · Protector de toalhas

	Ref	€	cm	Varilla (mm)	U.Venta
<b>A</b>	61129	13,70	18,5x18,5	5x3	1
	61130	17,80	25x25	5x3	1
	61131	17,80	30x20	5x3	1
<b>B</b>	61132	24,30	40x25	5x3	1

# Termos y botellas

## Thermos and bottles



### Jarras termo



- Jarras termo que mantienen los líquidos calientes y fríos durante horas.
- Ideales para servir café, leche o té.
- Cuerpo de polipropileno, ligero y muy cómodo.
- Doble pared con una capa de vidrio en el interior que proporciona un alto rendimiento térmico.
- Tapa aislante de rosca con botón de apertura que mantiene el calor y dispensa fácilmente las bebidas.

- Pichet isotherme qui maintient les liquides chauds et froids pendant des heures.
- Idéales pour servir le café, lait ou le thé.
- Corps en polypropylène, léger et très pratique.
- Double paroi avec ampoule en de verre à l'intérieur qui confère un haut rendement thermique.
- Couvercle isolant à vis avec poussoir d'ouverture qui maintient la chaleur et distribue facilement les boissons.

- Thermos jug that keeps liquids hot and cold for hours.
- Ideal for coffee, milk or tea.
- Polypropylene body, light and very comfortable.
- Double skin with a glass layer inside to provide high thermal performance.
- Insulated screw cap with opening button for easy pouring and to keep the heat in the jug.



Triple pared aislante  
Triple insulating wall



**Jarra termo Wood**  
Pichet thermo · Thermoskanne  
Termo jug · Jarra termo

**Jarra Termo**  
Pichet thermo · Thermoskanne  
Termo jug · Jarra termo

**Jarra Termo Push**  
Pichet thermo · Thermoskanne  
Termo jug · Jarra termo

	Ref	€	cm	L	U.Venta
A	62598	22,70	Ø13x25,3	1,00	1
B	62599	22,70	Ø13x25,3	1,00	1

	Ref	€	L	U.Venta
A	62563	15,30	1,00	1
	62564	17,50	1,50	1
B	62575	15,10	1,00	1
	62579	17,50	1,50	1

	Ref	€	L	U.Venta
	62496	27,80	0,60	1
	62491	39,90	1,20	1
	62492	50,10	2,00	1

# Jarras termo



- Jarras termo que mantienen los líquidos calientes y fríos durante horas.
- Ideales para servir café, leche o té.
- Doble pared que proporciona un alto rendimiento térmico.
- Boca amplia; facilita su llenado y su limpieza.



Termo Hermético  
Hermetic cap

## Jarra Termo Suite

Verseuse isothermo · Thermoskanne, idoliert  
Vacuum flask · Servidor termo

Ref	€	L	U.Venta
62522	51,30	1,6	1
62523	56,50	2,2	1

## Jarra Termo Quick

Bouteille thermo · Thermoskanne  
Insulated server · Jarra termo Luxe

Ref	€	L	U.Venta
62430	57,20	0,30	1
62460	63,40	0,60	1
62410	70,10	1,00	1
62415	90,30	1,50	1

## Jarra Termo Luxe

Bouteille thermo · Thermoskanne  
Insulated server · Jarra termo

Ref	€	L	U.Venta
63360	68,80	0,60	1
63310	74,90	1,00	1
63315	86,50	1,50	1
63320	92,20	2,00	1



### HINWEIS :

In Deutschland nicht verfügbar

## Jarra Termo White & Black

Verseuse isothermo · Thermoskanne, idoliert  
Vacuum flask · Servidor termo

Ref	€	L	U.Venta
62483	32,00	1,00	1
62484	32,00	1,00	1

## Jarra termo Pot

Verseuse isothermo · Thermoskanne, idoliert  
Vacuum flask · Servidor termo

Ref	€	L	h (cm)	U.Venta
62481	30,50	1,00	16	1
62485	36,10	1,50	20	1
62486	37,10	2,00	22	1



## Termo Bala Inox

Thermo pour liquides · Thermobehälter für Flüssigkeiten  
Thermo for liquids · Termo para líquidos

Ref	€	L	h(cm)	U.Venta
62441	12,30	0,35	20,0	1
62442	14,10	0,50	24,8	1
62443	19,00	0,75	29,8	1
62444	20,40	1,00	33,7	1

### NO UTILIZAR CON BEBIDAS GASEOSAS. CALDOS NI LÁCTEOS

DO NOT USE WITH FIZZY DRINKS,  
BROTHS OR DAIRY

- Mantiene las bebidas calientes o frías durante 24 horas.
- Doble pared que proporciona un alto rendimiento térmico.
- Ligero e irrompible.
- Boca ancha para cubos de hielo.
- Fácil de abrir y cerrar. Fácil limpieza.

- Keep hot or cold drinks for 24 hours.
- Double wall that provides high thermal performance.
- Light and unbreakable.
- Wide mouth for ice cubes.
- Easy to open and close. Easy cleaning.

## INOX

### Air Pot

Air pot · Getränkespender, isoliert  
Air pot · Air pot

Ref	€	L	h (cm)	U.Venta
62472	71,50	2,50	32,5	1
62473	77,60	3,00	34,5	1
62475	104,00	4,00	39,0	1



Boca ancha para cubitos hielo  
Wide mouth for ice cubes



# Termo alimentos



## Termo para alimentos Flora

Thermo pour aliments · Thermobehälter für Speisen  
Thermo for food · Termo para alimentos

Ref	€	h(cm)	L	U.Venta
62635	13,90	14,5	0,36	1
62636	24,20	15,0	0,50	1

## Termo para alimentos Inox

Thermo pour aliments · Thermobehälter für Speisen  
Thermo for food · Termo para alimentos

Ref	€	L	h(cm)	U.Venta
62448	21,50	0,70	19,7	1
62440	25,70	1,00	23,5	1

## Termo para alimentos Soft Touch

Thermo pour aliments · Thermobehälter für Speisen  
Thermo for food · Termo para alimentos

Ref	€	L	h(cm)	U.Venta
62480	53,50	1,50	18	1

# Botellas & Vasos



- Fabricadas en acero inoxidable 18/10 de la mejor calidad.
- Doble pared de aislamiento, no transmiten el calor o el frío.
- Tapón de rosca hermético, a prueba de filtraciones y antiderrames.
- No transmiten sabores ni olores.
- Libres de BPA.

- Fabriqué en acier inoxydable 18/10 de la meilleure qualité.
- Double paroi d'isolement, ne transmettez pas la chaleur ou le froid.
- Bouchage de fil hermétique, fuite de fuites et antiderrames.
- Il ne transmet pas les saveurs ou les odeurs.
- Sans BPA.

- Made of stainless steel 18/10 of the best quality.
- Double isolation wall, do not transmit heat or cold.
- Hermetic thread plug, leak-proof of leaks and antiderrams.
- It does not transmit flavors or odors.
- BPA free.

## Botellas Inox Edan

Bouteille inox · Stahlflasche  
Stainless steel bottle · Garrafa de aço inoxidável

Ref	€	L	U.Venta
62536	11,40	0,26	1
62537	12,40	0,50	1
62538	15,40	0,75	1
62546	11,40	0,26	1
62547	12,40	0,50	1
62548	15,40	0,75	1
62585	12,40	0,50	1
62588	12,40	0,50	1



Acabado exterior con proceso de revestimiento en polvo  
Outside finished with powder coating process

Tapón de madera con anilla para colgar  
Wood stopper with a ring for hanging



- Vaso reutilizable fabricado en vidrio borosilicato de gran espesor.
- Tapa de polipropileno con pestaña deslizando, libre de BPA.
- Cierre hermético; 100% a prueba de fugas. Banda de silicona antideslizante para un agarre seguro.
- Higiénico y resistente al contraste térmico. Diseñado para disfrutar de bebidas calientes o frías para llevar.
- No absorbe olores ni sabores. Fácil limpieza; apto para el lavavajillas.

- Reusable vessel manufactured in large thick borosilicate glass.
- Polypropylene lid with sliding tab, BPA free.
- Hermetic closure; 100% leak -proof. Non -slip silicone band for a safe grip.
- Hygienic and resistant to thermal contrast. Designed to enjoy hot or cold drinks to wear.
- It does not absorb odors or flavors. Easy cleaning; Apt for the dishwasher.

### Botella inox Flora

Bouteille inox · Stahlflasche  
Stainless steel bottle · Garrafa de aço inoxidável

Ref	€	L	U.Venta
62556	14,50	0,50	1
62559	16,10	0,75	1

Tapón con doble protección a prueba de goteo  
Drip proof double protected lid



Correa de transporte resistente  
Strong carrying strap

VIDRIO BOROSILICATO Borosilicate Glass  
PP Polypropylene  
SI Silicone  
Dishwasher

### Vaso Serve & Go

Timbale · Trinkbecher  
Tumbler · Copo

Ref	€	ml	Ø (cm)	h (cm)	U.Venta
63138	15,00	280	9	14,0	1
63139	17,00	450	9	17,0	1

### TRITAN

Plastic

### Botella personal Energy

Personnelle bouteille · Persönliche Flasche  
Personal bottle · Garrafa pessoal

Ref	€	L	U.Venta
61950	14,30	0,50	1
61965	15,50	0,65	1

Cierre hermético: tapa de rosca fabricada en bambú con junta de silicona  
Hermetic closure: thread cover made of bamboo with a silicone joint



Filtro infusor de acero inoxidable 18/10 extraíble  
Infusor filter of stainless steel 18/10 removable

Vidrio borosilicato de doble pared  
Double quality double wall borosilicate glass.



- Vaso reutilizable fabricado en acero inoxidable de doble pared. **Mantiene las bebidas calientes o frías durante más tiempo.**
- Tapa de polipropileno con cierre de rosca, libre de BPA.
- DobleClip, giro de 180°. Cierre hermético; 100% a prueba de fugas.
- Banda de silicona antideslizante para un agarre seguro.
- Base de silicona antideslizante.
- Higiénico y resistente al contraste térmico.
- Diseñado para disfrutar de bebidas calientes o frías para llevar.
- No absorbe olores ni sabores

new

- This reusable glass in double-walled stainless steel. Keeps drinks hot or cold for a longer period of time.
- It has a BPA free polypropylene lid with screw-on closure.
- DoubleClip, Up 180°. Hermetic Seal: 100% leak proof.
- It has a non-slip silicone band for a secure grip.
- It has a non-slip silicone base.
- It's hygienic and resistant to thermal shock.
- It's designed to enjoy hot and cold drinks on the go.
- It doesn't absorb odours or avours.

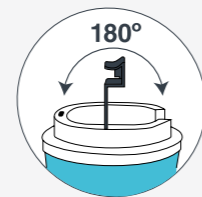

INOX  
PP Polypropylene  
SI Silicone

### Vaso termo Ocean

Timbale isotherme · Thermo-Trinkbecher  
Thermo tumbler · Copo térmico

Ref	€	ml	h(cm)	U.Venta
63134	11,10	350	15,0	1
63135	11,50	500	17,0	1

VIDRIO BOROSILICATO Borosilicate Glass  
BAMBOO  
INOX 18/10  
Dishwasher

### Botella termo infusora Flora

Bouteille thermos avec infuseur · Thermo-Teebereiter  
Infuser thermo bottle · Garrafa termo com infusor

Ref	€	Ø (cm)	h(cm)	ml	U.Venta
62534	15,70	6,6	21,5	350	1

Cafeteria  
Coffee

# Molinillos de café



**Molinillo Limu**  
Moulin à café · Kaffeemühle  
Coffe grinder · Moedor de café

Ref	€	W	Capacidad contenedor	U.Venta
69385	38,20	200	60 g	1

- Ideal para moler café y otros alimentos como semillas, hierbas, frutos secos, cereales, sal, pimienta o especias.
- Muele al instante. Muelas cerámicas extrafuertes: no pierden filo y no se oxidan.
- Molido a baja velocidad: conserva mejor las propiedades y aromas.
- Funcionamiento sencillo. Muy fácil de limpiar.
- 8 niveles de grosor: obtén la molienda perfecta para ocasión.

- Ideal for grinding coffee and other foods such as seeds, herbs, nuts, cereals, salt, pepper or spices.
- Move instantly. Extrafuertes ceramic teeth: do not lose edge and do not oxidize.
- Low speed: Better preserves properties and aromas.
- Simple operation. Very easy to clean.
- 8 thickness levels: get the perfect grinding for occasion.

**Mecanismo cerámico**  
Ceramic mechanism



**8 niveles de grosor**  
8 grinding levels

**CRISTAL INOX**  
Glass 18/10

**Molinillo manual**  
Moulin manuel · Manuelle Mühle  
Manual grinder · Moinho manual

Ref	€	W	Capacidad contenedor	U.Venta
62817	34,10		45 g	1

# Espumadores de leche



- Disfruta de una espuma fina y cremosa en pocos segundos.
- Base independiente rotativa de 360°, fácil de rellenar y verter.
- Funcionamiento silencioso. Apagado automático.
- Indicador de luz que visualiza si la leche está caliente o fría.
- Apta para leches vegetales. Fácil de limpiar.

- Profitez d'une mousse fine et crémeuse en quelques secondes.
- Base rotative à 360°, facile à remplir et à verser.
- Fonctionnement silencieux. Électricité automatique.
- Indicateur léger qui visualise si le lait est chaud ou froid.
- Convient aux laits de légumes. Facile à nettoyer.

- Enjoy a fine and creamy foam in a few seconds.
- 360° rotary base, easy to fill and pour.
- Silent functioning. Auto power off.
- Light indicator that visualizes whether the milk is hot or cold.
- Suitable for vegetable milks. Easy to clean.



**Espumador de leche Latte**  
Mousseur à lait · Milchaufschäumer  
Milk frother · Espumador de leite

**Espumador de leche Magnetic**  
Mousseur à lait · Milchaufschäumer  
Milk frother · Espumador de leite

Ref	€	W	Capacidad	Capacidad espuma	Medidas	U.Venta
69396	63,50	500	240ml	115 ml	Ø10x21 cm	1

Ref	€	W	Capacidad	Capacidad espuma	Medidas	U.Venta
69398	78,90	600	250ml	115 ml	Ø12x19,5 cm	1

# Cafeteras espresso



**Apta para café molido y cápsulas ESE**  
Suitable for ground coffee and ESE capsules



**Cafetera espresso Compact**  
Cafetière espresso · Espresso-Maschine  
Espresso coffee maker · Cafeteira espresso

Ref	€	W	Capacidad	Presión	Medidas	U.Venta
69429	235,20	1450	1,25L	20 bar	14x31x31 cm	1



**Prepara 1 o 2 cafés**  
Make 1 or 2 coffees



**Calienta y espuma la leche**  
Heat and froth milk



**Apta para café molido y cápsulas ESE**  
Suitable for ground coffee and ESE capsules



**Cafetera espresso Sence**  
Cafetière espresso · Espresso-Maschine  
Espresso coffee maker · Cafeteira espresso

Ref	€	W	Capacidad	Presión	Medidas	U.Venta
69256	189,20	850	1,5L	15 bar	21x26,5x30 cm	1



**Prepara 1 o 2 cafés**  
Make 1 or 2 coffees



**Calienta y espuma la leche**  
Heat and froth milk

- Ideal para preparar todo tipo de cafés, espresso, cappuccino, latte machiato, té o infusiones.
- Su sistema de calentamiento rápido Thermoblock calienta el agua en segundos.
- Función manual y automática. Permite programar el ciclo de vertido a tu gusto.
- Incluye vaporizador con rotación para espumar leche y preparar cappuccino. También dispensa agua caliente para las infusiones.
- Brazo portafiltros con doble salida, te permite preparar uno o dos cafés simultáneamente.
- Bandeja caliente tazas de acero inoxidable, calienta la taza previamente para evitar el contraste térmico.
- Incluye cucharilla dosificadora con prensador para el café y 3 filtros (individual, doble y para usar cápsulas ESE) para acoplar al brazo de la cafetera.
- Sistema de ahorro energético con apagado automático.
- Apta para usar con café molido y con cápsulas ESE.
- Ideal to prepare all kinds of coffees, espresso, cappuccino, late machiato, teas or infusions.
- Your fast heating system Thermoblock heats the water in seconds.
- Manual and automatic function. Allows you to program the dumping cycle to your liking.
- Includes rotation vaporizer for foam milk and prepare cappuccino. It also dispenses hot water for infusions.
- Double outlet portafiltros arm, allows you to prepare one or two coffees simultaneously.
- Heat stainless steel cups tray, heat the cup previously to avoid thermal contrast.
- Includes dosing teaspoon with coffee presser and 3 filters (individual, double and to use that) to attach to the coffee maker.
- Removable drip tray with level indicator to facilitate cleaning.
- Energy savings system with automatic shutdown.
- Suitable to use with ground coffee and that with that.

- Ideal para preparar todo tipo de cafés, espresso, cappuccino, latte machiato, té o infusiones.
- Café perfecto y rápido gracias a su potencia y sus bares de presión.
- Sistema de calentamiento rápido Thermoblock, calienta el agua en segundos.
- Fácil de usar, muy intuitiva. Indicadores luminosos en cada función.
- Función manual y automática. Permite programar el ciclo de vertido a tu gusto.
- Incluye vaporizador con rotación para espumar leche, preparar cappuccinos y también dispensar agua caliente para las infusiones.
- Brazo portafiltros con doble salida; te permite preparar uno o dos cafés simultáneamente.
- Depósito de agua extraíble con marcas de máximo y mínimo. Libre de BPA.
- Bandeja caliente tazas de acero inoxidable, calienta la taza previamente para evitar el contraste térmico.
- Bandeja de goteo desmontable con indicador de nivel para facilitar la limpieza.
- Sistema de ahorro energético con apagado automático.
- Apta para usar con café molido y con cápsulas ESE (69256 / 69429).

- Ideal to prepare all kinds of coffees, espresso, cappuccino, late machiato, teas or infusions.
- Perfect and fast coffee thanks to its power and pressure bars.
- Thermoblock fast heating system, heats the water in seconds.
- Easy to use, very intuitive. Luminous indicators in each function.
- Manual and automatic function. Allows you to program the dumping cycle to your liking.
- Includes rotation vaporizer for milk foam, prepare cappuccinos and also dispense hot water for infusions.
- Portafiltros arm with double outlet; It allows you to prepare one or two coffees simultaneously.
- Removable water tank with maximum and minimum marks. BPA free.
- Heat stainless steel cups tray, heat the cup previously to avoid thermal contrast.
- Removable drip tray with level indicator to facilitate cleaning.
- Energy savings system with automatic shutdown.
- Suitable for use with ground coffee and with that (69256 / 69429).



Accesorios  
Accessories



Depósito de café  
Coffee tank



Prepara  
1 o 2 cafés  
Make 1 or 2 coffees



Calienta y espuma  
la leche  
Heat and froth milk



- Ideal para preparar todo tipo de cafés, espresso, capuccino, latte machiato, tés o infusiones.
- Molinillo con fresa cónica de acero inoxidable integrado, proporciona la cantidad necesaria de café.
- Depósito de café de 250 g con opción de regular entre 30 tipos de molido. Libre de BPA.
- Control de temperatura PID. Alcanza la temperatura de extracción óptima.
- Fácil de usar, muy intuitiva. Indicadores luminosos en cada función.
- Función manual y automática. Permite programar la cantidad de vertido a tu gusto.
- Incluye vaporizador con rotación para espumar la leche y preparar cappuccino. También dispensa agua caliente para las infusiones.
- Brazo portafiltros con doble salida; te permite preparar uno o dos cafés simultáneamente.
- Incluye prensador de acero inoxidable para el café, 2 filtros (individual y doble) para acoplar al brazo de la cafetera y jarra de acero inoxidable de 0,46 L para la leche.
- Bandeja de goteo desmontable con indicador de nivel para facilitar la limpieza.
- Sistema de ahorro energético con apagado automático.

- deal to prepare all kinds of coffees, espresso, capuccino, late machiato, teas or infusions.
- Milling with conical stainless steel strawberry integrated, provides the necessary quantity of coffee.
- 250 g coffee tank with an option to regulate between 30 types of ground. BPA free.
- PID temperature control. Reach the optimal extraction temperature.
- Easy to use, very intuitive. Luminous indicators in each function.
- Manual and automatic function. It allows to program the amount of discharge to your liking.
- Includes rotation vaporizer to foam milk and prepare cappuccino. It also dispenses hot water for infusions.
- Portafilters arm with double outlet; It allows you to prepare one or two coffees simultaneously.
- Includes stainless steel presier for coffee, 2 filters (individual and double) to attach the coffee maker and 0.46 l stainless steel jug for milk.
- Removable drip tray with level indicator to facilitate cleaning.
- Energy savings system with automatic shutdown.

### Cafetera Espresso Pro

Cafetière espresso · Espresso-Maschine  
Espresso coffee maker · Cafeteira espresso

Ref	€	W	Capacidad	Capacidad contenedor	Presión	Medidas	U.Venta
69428	659,40	1550	2,8L	250 g (café/Coffee)	20 bar	31x34,5x41,5 cm	1

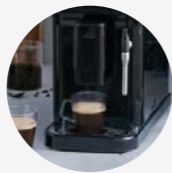

Doble salida de café regulable en altura  
Double coffee spout adjustable in height

Prepara  
1 o 2 cafés  
Make 1 or 2 coffees



Calienta y espuma  
la leche  
Heat and froth milk



- Cafetera superautomática compacta y diseñada para los amantes del café recién molido. Pantalla intuitiva táctil.
- Disfruta del café recién hecho con grano molido.
- Se puede ajustar la cantidad de café para cada una de las 3 funciones.
- Molinillo ajustable de muelas cónicas: 15 niveles de molienda. Ajusta el grano de molienda a tu gusto.
- Gran capacidad: Hasta 180 gramos de café y depósito de agua de 1,5L.
- Calentamiento ThermoBlock: Sistema eléctrico de calentamiento del agua ultra rápido. Disfruta de un café recién molido al instante.
- Doble salida de café regulable en altura desde 8,5 cm hasta 11,5 cm.
- AutoClean System: Sistema de limpieza automático.
- Molinillo y depósito para residuo totalmente accesible: facilita su limpieza.
- Incluye vaporizador para calentar y espumar la leche o calentar agua para infusiones.

- Machine à café superautomatique compacte conçue pour les amateurs de café fraîchement moulu. Écran tactile intuitif.
- Savourez un café fraîchement préparé avec des grains moulus.
- La quantité de café est réglable pour chacune des 3 fonctions.
- Moulin conique réglable : 15 niveaux de mouture. Ajustez la mouture à votre goût.
- Grande capacité : Jusqu'à 180 grammes de café et un réservoir d'eau de 1,5 litre.
- Chauffage ThermoBlock : Système de chauffage électrique de l'eau ultra-rapide. Profitez instantanément d'un café fraîchement moulu.
- Double écoulement de café réglable en hauteur de 8,5 cm à 11,5 cm.
- Système AutoClean : Système de nettoyage automatique.
- Le moulin et le bac à déchets sont entièrement accessibles, ce qui facilite le nettoyage.
- Mousseur inclus pour chauffer et faire mousser le lait ou chauffer l'eau pour les infusions.

- Compact superautomatic coffee machine designed for lovers of freshly ground coffee.
- Enjoy freshly brewed coffee with ground beans. Intuitive touch screen
- The amount of coffee can be adjusted for each of the 3 functions.
- Adjustable conical grinder: 15 grinding levels. Adjust the grind to your taste.
- Large capacity: Up to 180 grams of coffee and 1.5L water tank.
- ThermoBlock heating: Ultra-fast electric water heating system. Enjoy freshly ground coffee instantly.
- Double coffee spout adjustable in height from 8.5 cm to 11.5 cm.
- AutoClean System: Automatic cleaning system.
- Fully accessible grinder and waste container: easy to clean.
- Includes frother for heating and frothing milk or heating water for infusions.

### Cafetera automática Sabore

Machine à café automatique · Automatische Kaffeemaschine  
Automatic coffee machine · Máquina de café automática

Ref	€	W	Capacidad	Capacidad contenedor	Presión	Medidas	U.Venta
69435	554,10	1350	1,5L	180g	20 bar	44x19x32 cm	1



## Cafeteras Italianas Inox



- Cafetera italiana fabricada en acero inoxidable 18/10 de gran calidad y máxima resistencia.
- Máxima seguridad garantizada: dispone de válvula de seguridad y asa termoresistente.
- 100% hermético gracias a su junta de cierre de silicona.
- Alta conductividad térmica.
- Fondo FULL INDUCTION: apta para todo tipo de fuegos, incluida la inducción.

- Cafetière italienne fabriquée en acier inoxydable 18/10 de haute qualité et résistance maximale.
- Sécurité maximale garantie: il a une soupape de sécurité et une poignée résistante au thermor.
- 100% hermétique grâce à son articulation de fermeture en silicone.
- Haute conductivité thermique.
- Fonds complet à induction: Convient à tous les types d'incendies, y compris l'induction.

Disponen de válvula de seguridad  
They have a safety valve



- Italian coffee maker manufactured in stainless steel 18/10 of high quality and maximum resistance.
- Maximum guaranteed security: It has safety valve and thermor resistant handle.
- 100% hermetic thanks to its silicone closure joint.
- High thermal conductivity.
- Full induction fund: suitable for all types of fires, including induction.

Acabado MATE  
SATIN finish



Acabado BRILLO  
GLOSS finish



Acabado BRILLO  
GLOSS finish



### Cafetera Express Hyperluxe

Cafetière express · Esspressokocher  
Express coffee · Cafeteira café expresso

Ref	€	Tazas	U.Venta
62074	82,60	4	1
62076	91,20	6	1
62071	104,30	10	1

Acabado BRILLO  
GLOSS finish



### Cafeteras Express Luxe

Cafetière express · Esspressokocher  
Express coffee · Cafeteira café expresso

Ref	€	Tazas	U.Venta
62084	67,60	4	1
62086	78,90	6	1
62081	93,20	10	1

Acabado BRILLO  
GLOSS finish



### Cafeteras Express Moka

Cafetière express · Esspressokocher  
Express coffee pot · Cafeteira espresso

Ref	€	Tazas	U.Venta
62054	56,50	4	1
62056	64,70	6	1
62051	76,70	10	1

Acabado BRILLO  
GLOSS finish



### Cafetera Pava

Cafetière pava · Kaffeekanne Pava  
Coffee pot · Chaleira

Ref	€	L	U.Venta
68215	35,60	1,00	1
68225	42,90	2,00	1
68235	52,40	2,80	1
68205	60,30	4,00	1

### Cafetera Express Milan

Cafetière express · Esspressokocher  
Express coffee pot · Cafeteira espresso

Ref	€	Tazas	U.Venta
62033	22,10	4	1
62036	25,80	6	1
62031	32,20	10	1

### Cafetera Express Siena

Cafetière express · Esspressokocher  
Express coffee pot · Cafeteira espresso

Ref	€	Tazas	U.Venta
62124	49,90	4	1
62126	60,30	6	1
62121	72,10	10	1





## Cafeteras Italianas Aluminio



- Cafetera italiana fabricada en aluminio fundido de gran calidad y máxima resistencia.
- Máxima seguridad garantizada: dispone de válvula de seguridad y asa de baquelita (Turin) / asa de madera de Haya (Trento) termorresistente.
- 100% hermético gracias a su junta de cierre de silicona.
- Alta conductividad térmica.

- Cafetières italienne fabriquées en fonte d'aluminium de grande qualité et d'une résistance maximale.
- Sécurité maximum garantie : dispose d'une soupape de sécurité et d'une anse en bakélite (Turin) anse en bois de hêtre (Trento) thermostable.
- 100% hermétique grâce à son joint de fermeture en silicone.

- Haute conductivité thermique.
- Moka pot coffee maker made of high quality and very strong cast aluminium.
- Guaranteed maximum safety: pressure valve and heat resistant bakelite handle (Turin) / beech wood handle (Trento).
- 100% Hermetic because of the silicone seal.
- High thermal conductivity.



**Cafetera Express Turin**  
Cafetière express · Espresso-Kocher  
Express coffee pot · Cafeteira expresso

Ref	€	Tazas	Base (cm)	U.Venta
62026	17,40	6	9,5	1
62029	21,70	9	10,5	1
62022	23,90	12	12,0	1



**Cafetera Express Trento**  
Cafetière express · Espresso-Kocher  
Express coffee pot · Cafeteira expresso

	Ref	€	Tazas	Base (cm)	h(cm)	U.Venta
A	62046	30,70	6	8,5	20,0	1
	62048	39,10	9	9,0	22,5	1
B	62096	30,70	6	8,5	20,0	1
	62099	39,10	9	9,0	22,5	1



## Cafeteras Francesas

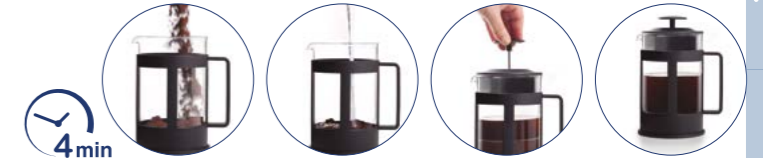

- Fabricada en vidrio borosilicato, superresistente a los cambios de temperatura.
- Filtro robusto de acero inoxidable 18/10; asegura una buena textura y sabor.
- Forma práctica y sencilla de preparar los mejores cafés e infusiones en pocos minutos.

- Fabriqué dans du verre borosilicé, changements de température.
- Filtre inoxydable en acier inoxydable 18/10; Assure une bonne texture et une bonne saveur.
- Moyen pratique et simple de préparer les meilleurs cafés et perfusions en quelques minutes.

- Manufactured in borosilicate glass, temperature changes.
- Stainless steel stainless filter 18/10; ensures good texture and flavor.
- Practical and simple way to prepare the best coffees and infusions in a few minutes.



A

Copper



B

Black



### Cafetera francesa

Cafetière à piston · Französische Kaffemaschine  
French coffee maker · Cafeteira francesa

	Ref	€	Tazas	L	U.Venta
A	62173	19,60	3	0,35	1
	62178	26,80	6	0,80	1
B	62183	8,50	3	0,35	6
	62186	13,20	6	0,80	1

### Cafetera francesa Wood

Cafetière à piston · Französische Kaffemaschine  
French coffee maker · Cafeteira francesa

	Ref	€	Tazas	L	U.Venta
A	62163	11,20	3	0,35	1
	62168	15,00	6	0,80	1
B	62161	15,50	8	1,00	1

### INOX



### Cafetera de cristal

Cafetière en verre · Glaskaffeemaschine  
Coffee pot w/glass · Cafeteira vidro

	Ref	€	Tazas	L	U.Venta
A	62153	30,40	2	0,35	1
	62180	43,10	6	0,80	1

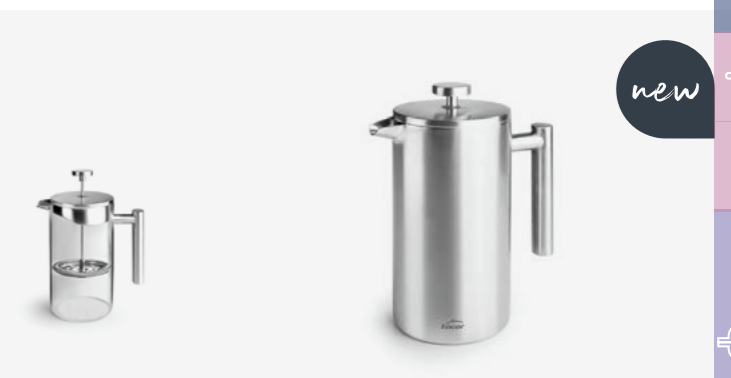

### Cafetera Francesa Inox

Cafetière à piston inox · Französische Kaffeepresse inox  
French coffee maker inox · Cafeteira francesa inox

	Ref	€	L	U.Venta
A	62141	39,60	1,0	1

# Classic Collection

INOX 18/10  
Dishwasher



**Tetera**  
Théière · Teekanne  
Tea pot · Bule

Ref	€	L	U.Venta
62023	19,40	0,23	12
62035	21,60	0,35	12
62060	29,40	0,60	6
62010	36,10	1,00	1



**Cafetera**  
Cafetière · Kaffeekanne  
Coffee pot · Cafeteira

Ref	€	L	U.Venta
62135	23,50	0,35	6
62160	31,60	0,60	6
62110	35,00	1,00	6
62115	48,90	1,50	1
62120	56,30	2,00	1



**Lechera**  
Cremiere · Milchkanne  
Creamer · Leiteira

Ref	€	L	U.Venta
62215	9,00	0,15	6
62225	14,40	0,25	6
62235	15,10	0,35	6
62260	17,70	0,60	6
62210	22,10	1,00	6
62216	34,30	1,50	6
62220	40,90	2,00	1

**Azucarero**  
Sucrier · Zuckerdose  
Sugar bowl · Açucareiro

Ref	€	L	U.Venta
62001	16,40	0,23	6
62003	21,30	0,35	1

# Luxe Collection

INOX 18/10  
Dishwasher



**Tetera**  
Théière · Teekanne  
Tea pot · Bule

Ref	€	L	U.Venta
65025	38,80	0,25	1
65035	41,10	0,35	1
65060	48,50	0,60	1
65012	61,00	1,20	1



**Cafetera**  
Cafetière · Kaffeekanne  
Coffee pot · Cafeteira

Ref	€	L	U.Venta
65135	40,50	0,35	1
65160	48,40	0,60	1
65110	61,40	1,00	1



**Lechera**  
Cremiere · Milchkanne  
Creamer · Leiteira

Ref	€	L	U.Venta
65215	14,70	0,15	6
65235	25,20	0,35	6
65260	30,30	0,60	6

# Batidor Capuccino

INOX AS Plastic Dishwasher BPA free



**Batidor Capuccino**  
Batteur pour cappuccino · Capuccino-Mixer  
Capuccino mixer · Batedor capuccino

Ref	€	W	U.Venta
69041	27,40	2,7	1

Incluye: Vaso medidor  
Base para guardar el batidor y varillas  
Varilla agitadora  
Varilla para espumar  
Batidor  
Mezclador

Includes: Measuring cup  
Base to store the whisk and rods  
Stirring rod  
Frothing rod  
Whisk  
Mixer

# Teteras de hierro

FE CAST Iron Colado Induction Vitro Electric Gas Dishwasher ECO PFOA free

- Fabricadas artesanalmente en hierro fundido de alta calidad muy resistentes.
- Incluyen infusor extraíble de acero inoxidable.
- Interior esmaltado para evitar la oxidación.
- Se recomienda hacer uso de un hervidor para calentar el agua y evitar así que pierda el color.

- Fonte de haute qualité fait à la main.
- Ils comprennent des infuseurs en acier inoxydable amovibles.
- Intérieur émaillé pour éviter l'oxydation.
- Il est recommandé d'utiliser une bouilloire pour chauffer l'eau et éviter de perdre la couleur.

- Handmade high quality cast iron.
- They include removable stainless steel infuses.
- Enameled interior to avoid oxidation.
- It is recommended to use a kettle to heat the water and avoid losing the color.



Incluye filtro extraíble de acero inoxidable  
Includes removable stainless steel filter



**Tetera**  
Théière · Teekanne  
Tea pot · Bule

Ref	€	L	U.Venta
68663	30,10	0,25	1
68667	40,30	0,50	1
68666	33,60	0,60	1
68664	49,00	0,70	1
68662	44,90	0,80	1
68668	36,90	0,80	1
68661	41,60	1,10	1



# Lecheras Collection



INOX

## Lechera

Pot crémier · Milchkanne  
Milk jug · Leiteira

	Ref	€	L	U.Venta
A	58151	14,00	0,35	1
	58152	16,70	0,60	1
B	58251	14,00	0,35	1
	58252	16,70	0,60	1
C	58153	14,00	0,35	1
	58253	16,70	0,60	1



INOX 18/10

## Lechera Barista

Pot crémier pour baristas · Milchkanne für Baristas  
Barista milk jug · Leiteira barista

	Ref	€	L	U.Venta
A	58050	29,20	0,50	1
B	58150	32,20	0,50	1
C	58250	32,20	0,50	1
D	58450	32,10	0,50	1

# Hervidor Silbante



## Hervidor Silbante

Bouilloire siffiante · Flötenwasserkessel  
Whistling kettle · Chaleira com apito

	Ref	€	L	U.Venta
A	68619	38,40	2,00	1
	68627	40,50	2,50	1
	68629	43,00	3,00	1
	68639	44,50	4,00	1
B	68643	47,70	2,50	1
C	68644	47,70	2,50	1



Alto nivel de calidad y resistencia.  
Apto para hervir agua o calentar café preparado.  
Emite un ligero silbido cuando el agua hierve.

High level of quality and resistance.  
Apt to boil water or heat prepared coffee.  
It emits a slight whistle when the water boils.

# Dispensador de agua caliente



## Dispensador de agua caliente

Distributeur d'eau chaude · Heißwasserspender  
Hot water dispenser · Dispensador de água quente

Ref	€	L	W	Niveles calentamiento	Medidas	U.Venta
69298	127,90	2 L	2400	25°C - 70°C - 85°C - 95°C	32x17x33 cm	1

Agua caliente en 5 segundos  
Hot water in 5 seconds



Bandeja de goteo extraíble e imantada  
Removable and magnetic drip tray

# Hervidores de agua



Base independiente rotativa de 360°  
Independent base rotates 360°



Interior inox 18/10  
Interior 18/10 st. steel



Interior inox 18/10.  
Interior 18/10 st. steel.



CE  
Ceramic

## Hervidor de agua Retro

Bouilloire électrique · Elektrische Wasserwamer  
Electric kettle · Chaleira eléctrica

Ref	€	W	Capacidad	Medidas	U.Venta
69397	59,80	2200	1,7L	26 x 19,5 x 26,5 cm	1



## Hervidor de agua

Bouilloire · Wasserwamer  
Kettle · Chaleira

	Ref	€	W	L	Medidas	U.Venta
A	69591	22,60	2200	1,3	20x15x21 cm	1
B	69590	22,60	2200	1,3	20x15x21 cm	1



Fácil llenado  
Easy filling



## Hervidor de agua Rapid

Bouilloire · Wasserwamer  
Kettle · Chaleira

Ref	€	W	Capacidad	Medidas	U.Venta
69291	40,90	1630	1,0L	22 x 16 x 21 cm	1
69297	51,10	2200	1,7L	22 x 18 x 23 cm	1



## Hervidor de agua Lake

Bouilloire · Wasserwamer  
Kettle · Chaleira

Ref	€	W	Capacidad	Medidas	U.Venta
69277	61,30	2200	1,7 L	23 x 16 x 23 cm	1



Protección de ebullición en seco  
Dry boil protection

CRISTAL  
Glass

## Hervidor de agua Vista

Bouilloire · Wasserwamer  
Kettle · Chaleira

Ref	€	W	L	Medidas	U.Venta
69292	80,70	2200	1,70	23x23x32 cm	1



50 - 95°C max

# Bar / Bodega

## Bar / Wine cellar



## Fundas enfriabotellas



- **Funda térmica; enfría y mantiene la temperatura durante más tiempo.**
  - **Se adapta a todo tipo de botellas.**
  - **Cubre prácticamente toda la botella, desde la base hasta al cuello.**
  - **Nota: mete la funda térmica en el congelador antes de su uso. El gel refrigerante no es tóxico. Para lavarlo, utilizar un paño húmedo. No apto para el lavavajillas.**
- Cas thermique; refroidir et garder la température plus longtemps.
  - Il s'adapte à tous les types de bouteilles.
  - Il couvre pratiquement toute la bouteille, de la base au cou.
  - Remarque: Mettez le boîtier thermique dans le congélateur avant utilisation. Le gel réfrigérant n'est pas toxique. Pour le laver, utilisez un chiffon humide. Pas adapté au lave-vaisselle.
- Thermal case; cool and keep the temperature for longer.
  - It adapts to all types of bottles.
  - It covers practically the entire bottle, from the base to the neck.
  - Note: put the thermal case in the freezer before use. Refrigerant gel is not toxic. To wash it, use a damp cloth. Not suitable for dishwasher.



### Fundas enfriabotellas

Housse de refroidissement de bouteilles · Flaschenkühler  
 Bottle cooler cover · Arrefecedor de garrafas

	Ref	€	cm	h (cm)	U.Venta
<b>A</b>	62276	15,10	15x23	3,5	1
<b>B</b>	62277	15,10	15x23	3,5	1
<b>C</b>	62270	15,10	15x23	3,5	1
<b>D</b>	62288	14,70	15x23	3,5	1

### Fundas enfriabotellas Classic

Housse de refroidissement de bouteilles · Flaschenkühler  
 Bottle cooler cover · Arrefecedor de garrafas

	Ref	€	U.Venta
<b>A</b>	62325	10,90	6
<b>B</b>	62355	11,60	6

# Cubiteras



**Cubitera de silicona flexible. Fácil de desmoldar**  
Flexible silicone ice cube tray/Easy to unmould



**Cubitera Glacier**  
Bac à glaçon · Eiwürfelschale  
Ice cube tray · Cuvete para gelo

Ref	€	Cubitos	Cubitos (cm)	cm	h(cm)	U.Venta
63336	16,90	32	2,5x2,5x1,8	22,5x12	10,5	1

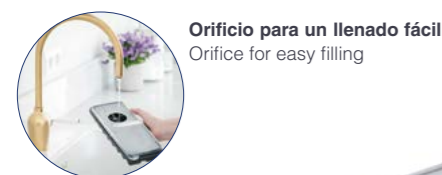

**Orificio para un llenado fácil**  
Orifice for easy filling

**Cubitera Fresh**  
Bac à glaçon · Eiwürfelschale  
Ice cube tray · Cuvete para gelo

Ref	€	Cubitos	Cubitos (cm)	cm	h(cm)	U.Venta
63337	4,40	16	4,5x3x3	30x11,5	4,6	1

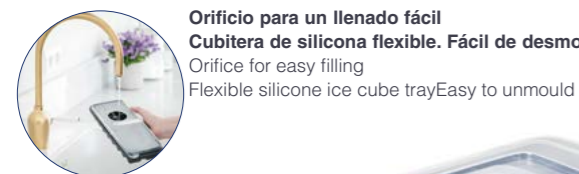

**Orificio para un llenado fácil**  
**Cubitera de silicona flexible. Fácil de desmoldar**  
Orifice for easy filling  
Flexible silicone ice cube tray/Easy to unmould

**Cubitera Ice**  
Bac à glaçon · Eiwürfelschale  
Ice cube tray · Cuvete para gelo

Ref	€	Cubitos	Cubitos (cm)	cm	h(cm)	U.Venta
63338	8,70	15	3x3x2,5	20x11,5	3,5	1

**Cubitera de silicona flexible. Fácil de desmoldar**  
Flexible silicone ice cube tray/Easy to unmould



**Cubitera Ice XL**  
Bac à glaçon · Eiwürfelschale  
Ice cube tray · Cuvete para gelo

Ref	€	Cubitos	Cubitos (cm)	cm	h(cm)	U.Venta
63339	8,30	6	4,5x4,5x4,5	15,5x10,5	4,5	1

- **Cubitera de hielo fabricada en silicona de grado alimenticio.**
- **Capacidad para hacer 32 cubitos de hielo de 2,5x2,5x1,8 cm de tamaño.**
- **Contenedor fabricado en polipropileno para almacenar hasta 96 cubitos.**
- **Evita que los hielos adquieran sabores u olores.**
- **Incluye 2 tapas para tapar la cubitera y el contenedor de manera simultánea.**
- **Gracias a su gran flexibilidad podrás sacar los cubitos de forma rápida y sencilla.**
- **Libre de BPA.**

- Ice cube tray made of food grade silicone.
- Capacity for making 32 2,5x2,5x1,8 cm ice cubes.
- Container made of polypropylene for storing up to 96 ice cubes.
- Keeps the ice cubes from taking on flavours or odours.
- Includes 2 lids for covering the ice cube tray and the container at the same time.
- You can get the ice cubes out quickly and easily and almost effortlessly because it's extremely flexible.
- BPA free.

- **Cubitera de hielo fabricada en polipropileno. Libre de BPA.**
- **Capacidad para hacer 16 cubitos de hielo de 4,5x3x3 cm de tamaño.**
- **Evita que los hielos adquieran sabores u olores gracias a su tapa hermética.**
- **La tapa incluye un orificio para un llenado fácil sin derrames o salpicaduras.**

- Bac à glaçons fabriqué en polypropylène. Sans BPA.
- Capacité pour faire 16 glaçons d'une taille de 4,5x3x3 cm.
- Évite aux glaçons d'absorber des goûts ou des odeurs grâce à son couvercle hermétique.
- Le couvercle comprend un trou pour faciliter le remplissage sans renverser ou éclabousser.

- Ice cube tray made of polypropylene. BPA free.
- Capacity for making 16 ice cubes of 4,5x3x3 cm in size.
- Keeps the ice cubes from taking on flavours or odours thanks to its hermetic lid.
- The lid includes a hole for easy filling without spilling or splashing.

- **Cubitera de hielo fabricada en silicona. Libre de BPA.**
- **Capacidad para hacer 15 cubitos de hielo de 3x3x2,5 cm de tamaño.**
- **Evita que los hielos adquieran sabores u olores gracias a su tapa hermética.**
- **La tapa incluye un orificio para un llenado fácil sin derrames o salpicaduras.**
- **Gracias a su gran flexibilidad podrás sacar los cubitos de forma rápida y sencilla.**

- Ice cube tray made of silicone. BPA free.
- Capacity for making 15 ice cubes of 3x3x2,5 cm in size.
- Keeps the ice cubes from taking on flavours or odours thanks to its hermetic lid.
- The lid includes a hole for easy filling without spilling or splashing.
- You can get the ice cubes out quickly and easily and almost effortlessly because it's extremely flexible.

- **Cubitera de hielo fabricada en silicona. Libre de BPA.**
- **Capacidad para hacer 6 cubitos de hielo XL de 4,5x4,5x4,5 cm de tamaño.**
- **Mantiene las bebidas frías durante más tiempo.**
- **Gracias a su gran flexibilidad podrás sacar los cubitos de forma rápida y sencilla.**

- Bac à glaçons fabriqué en silicone. Sans BPA.
- Capacité pour faire 6 glaçons XL d'une taille de 4,5x4,5x4,5 cm.
- Garde les boissons plus froides plus longtemps.
- Grâce à sa grande flexibilité, les glaçons pourront être retirés de façon rapide et simple, presque sans efforts.

- Ice cube tray made of silicone. BPA free.
- Capacity for making 6 XL ice cubes of 4,5x4,5x4,5 cm in size.
- Keeps drinks cold for longer.
- You can get the ice cubes out quickly and easily and almost effortlessly because it's extremely flexible.

# Moon Collection

INOX  
18/10

- **Cuerpo de acero inoxidable 18/10, resistente a la corrosión.**
- **Diseño elegante y actual.**
- **Muy cómodo y fácil de desplazar gracias a su asa de cuero.**
- **Asa de piel vacuno acabado en curtido vegetal de 3 mm de grosor.**
- **Acabado exterior negro mate e interior lijado.**

- 18/10 corps en acier inoxydable, résistant à la corrosion.
- Conception élégante et actuelle.
- Très confortable et facile à déplacer grâce à sa poignée en cuir.
- Poignée en cuir vide finie en bronzage de légumes de 3 mm d'épaisseur.
- Finition extérieure noire mate et intérieure.

- 18/10 stainless steel body, corrosion resistant.
- Elegant and current design.
- Very comfortable and easy to move thanks to its leather handle.
- Vacune leather handle finished in 3 mm thick vegetable tanning.
- Matte and interior black exterior finish.



**Cubitera Moon**

Seau à glace · Sektkühler  
Ice bucket · Porta-cubos de gelo

	Ref	€	Ø (cm)	h (cm)	L	U.Venta
<b>A</b>	65414	41,10	14	12	1,5	1
<b>B</b>	65614	35,50	14	12	1,5	1



**Enfriabotellas Moon**

Seau à champagne · Champagnerkühler  
Wine bucket · Arrefecedora de garrafas

	Ref	€	Ø (cm)	h (cm)	L	U.Venta
<b>A</b>	65418	48,70	18	19,0	4,0	1
	65420	58,10	20	19,5	5,6	1
<b>B</b>	65618	45,00	18	19,0	4,0	1
	65620	54,00	20	19,5	5,6	1



**Champanero Moon**

Refräichisseur à champagne · Champagnerkühler  
Champagne cooler · Champanheiro

	Ref	€	Ø (cm)	h (cm)	L	U.Venta
<b>A</b>	65436	123,60	36	20,5	11,5	1
<b>B</b>	65636	123,60	36	20,5	11,5	1

**Champanero inclinado Moon**

Refräichisseur à champagne incliné · Schräger Champagnerkühler  
Inclined champagne cooler · Champanheiro inclinado

	Ref	€	Ø (cm)	h (cm)	L	U.Venta
<b>A</b>	65440	122,30	40	27	15	1
<b>B</b>	65640	122,30	40	27	15	1



**Barreño Moon**

Bassine · Glatzwanne  
Mirror cooler · Bacia

	Ref	€	Ø (cm)	h (cm)	L	U.Venta
<b>A</b>	65450	108,30	50	21	30	1
<b>B</b>	65650	108,30	50	21	30	1



# Enfriabotellas

INOX 18/10  
Dishwasher

- Amplia gama de enfriadores de botellas para el vino o champán.
- Fabricados en acero inoxidable de gran calidad.
- Ideal para uso doméstico y profesional.

- Large gamme de rafraîchisseurs de bouteilles pour le vin ou le champagne.
- Fabriqué en acier inoxydable de haute qualité.
- Idéal pour un usage domestique et professionnel.

- Wide range of bottle coolers for wine or champagne.
- Made of high quality stainless steel.
- Ideal for domestic and professional use.

Compatible con:  
Compatible with:

- 62315
- 62320
- 62322
- 62321
- 61321
- 61319
- 14121
- 62365
- 62362
- 65418
- 65420
- 65618
- 65620

INOX

## Pie porta cubos

Porte-seau à champagne · Sektkühlerständer  
Wine cooler stand · Pé porta baldes

Ref	€	Ø (cm)	h(cm)	U.Venta
62300	92,50	20	65	1



Sujeción segura y estable en cualquier mesa  
Secure and stable hold on any table



FE Iron  
CRO Cromado Chrome

## Soporte de mesa enfriabotellas

Support seu à champagne · Tischhalterung für Sektkühler  
Wine cooler table support · Sup. balde de gelo arrefecedor

Ref	€	Ø (cm)	U.Venta
62478	13,20	18	1
62479	13,20	20	1

Anilla de acero inoxidable  
Stainless steel ring

Doble pared aislante  
Acabado SOFT TOUCH  
Double insulating wall  
SOFT TOUCH finish



Dishwasher

## Enfriabotellas Black

Seau à vin · Champagnerkühler  
Vine bucket · Balde enfria-garrafas

Ref	€	Ø (cm)	Diámetro interior (cm)	h(cm)	U.Venta
62356	17,00	12,5	9,50	20	1



Apta para la mayoría de las botellas de vino o champán  
Fits most bottles of red wine or champagne



Dishwasher

## Enfriabotellas Inox

Seau à champagne · Champagnerkühler  
Champaing cooler · Arrefecedora de garrafas

Ref	€	Ø (cm)	h(cm)	U.Venta
62389	31,90	10,5	19,5	1

Doble pared aislante  
Double insulating wall



## Cubitera

Seau à glace · Sektkühler  
Ice bucket · Porta-cubos de gelo

Ref	€	Ø (cm)	h (cm)	L	U.Venta
62315	32,60	14	12	1,20	1
62320	44,30	20	19	4,50	1
62322	53,20	22	20	5,50	1
14121	19,70	20	20	4,00	1
62321	64,80	18	20	5,50	1
61321	25,30	20	21	4,25	1
61319	27,40	20	22	4,75	1
62338	84,30	30	20	7,00	1

A Luxe



B Garinox



C Suite



Inox

garinox®

D Cooler



Inox

E Conic



Inox

F Line



## Champanero

Refrâchisseur à champagne · Champagnerkühler  
Champagne cooler · Champanheiro

Ref	€	Ø (cm)	h (cm)	L	U.Venta
62336	134,80	36	28,0	11,50	1
62436	124,60	36	23,0	11,50	1
62439	136,00	40	26,0	15,00	1
62346	88,40	36	20,5	13,0	1
62271	59,80	43x30	20,0	20,00	1
62272	72,00	53x38	25,0	27,00	1
62273	84,20	61x43	28,0	32,00	1

A

Star



B

Luxe



C

Chef



D

Oval



# Enfriabotellas



Acabado metalizado  
Metallic finish

ABS  
Plastic

## Enfriabotellas Artic

Seau à champagne · Champagnerkühler  
Champaing cooler · Arrefecedora de garrafas

Ref	€	Ø (cm)	h(cm)	L	U.Venta
61331	20,10	20	25	3,50	1

## Enfriabotellas Boat Black

Seau à champagne · Champagnerkühler  
Champaing cooler · Arrefecedora de garrafas

Ref	€	Base	cm	h(cm)	L	U.Venta
A 62354	34,30	13,5x16	20,5x25,5	28,5	4,00	1
B 62367	35,60	16x12	27x20	20,0	3,00	1
B 62368	51,40	21x15,5	35x26,5	26,0	7,00	1



## Enfriabotellas

Seau à champagne · Champagnerkühler  
Champaing cooler · Arrefecedora de garrafas

Ref	€	Base	cm	h(cm)	L	U.Venta
A 62364	18,50	16	22x18	23	3,00	1
B 62365	34,20	13,5x16	20,5x25,5	28,5	4,50	1
C 62366	41,10	13,5x18,5	21,5x30,5	26	5,50	1



## Enfriabotellas Bloom

Seau à champagne · Champagnerkühler  
Champaing cooler · Arrefecedora de garrafas

Ref	€	Ø (cm)	h(cm)	L	U.Venta
A 62362	12,90	22	21	3,50	1
B 62371	29,60	33	25	10,00	1

## Enfriabotellas Bubble

Seau à champagne · Champagnerkühler  
Champaing cooler · Arrefecedora de garrafas

Ref	€	cm	h(cm)	L	U.Venta
62373	31,10	47x29	23	13,00	1



# Jarras



2 Tapa con doble posición  
Filtro-colador integrado en la tapa (2) el hielo, las hierbas aromáticas o la fruta es retenida en el vertido  
1 Double position lid  
Filter-strainer integrated in the lid (2).  
Ice, aromatic herbs or fruit is held in place while pouring



Jarra  
Pot à eau · Wasserkanne  
Water jug · Jarra

Ref	€	cm	h(cm)	L	U.Venta
A 61952	16,60	14x9,2	27,3	1,70	1
B 61953	15,40	13,8x8,5	22,8	1,00	1

- Jarra fabricada en vidrio borosilicato ultrarresistente. Resistente a los choques térmicos.
- Tapa extraíble de acero inoxidable 18/10 diseñada para conseguir un cierre hermético. (fresh).
- Tapa extraíble de fibra de bambú diseñada para conseguir un cierre hermético (Sea).
- Colador integrado: el hielo, las hierbas aromáticas o la fruta es retenida en el vertido.
- Perfecta para bebidas calientes o frías como agua, limonada, té, sangría, leche, etc. Ideal para llevar las bebidas a la mesa o guardarlas en la nevera.
- Diseño moderno y elegante. Mango ergonómico y pico vertedor para evitar derrames.
- Gran apertura que facilita su llenado y su limpieza.
- Apta para el lavavajillas.

- Jug made of ultra -resistant borosilicate glass. Resistant to thermal shocks.
- Removable stainless steel lid 18/10 designed to get a hermetic closure (fresh).
- Couvercle en fibre de bambou amovible conçu pour obtenir une fermeture hermétique (Sea).
- Integrated strainer: ice, aromatic herbs or fruit is retained on the discharge.
- Perfect for hot or cold drinks such as water, lemonade, tea, bleeding, milk, etc. Ideal to bring drinks to the table or save them in the fridge.
- Modern and elegant design. Ergonomic mango and pico to avoid spills.
- Great opening that facilitates its filling and cleaning.
- Suitable for dishwasher.



- Jarra dispensadora fabricada en cristal de máxima calidad.
- Grifo integrado para servir la cantidad de bebida deseada directamente en el vaso. Tapa de acero con cierre hermético.
- Perfecta para bebidas frías como agua, limonada, zumo, sangría, etc. Ideal para buffet, área de reuniones, recepciones de hoteles, etc.
- Gran apertura que facilita su llenado y su limpieza. Capacidad de 5,5 L.
- Jarra apta para el lavavajillas.

- Dispenser jug made of maximum quality crystal.
- Integrated tap to serve the amount of drink desired directly in the glass. Steel lid with airtight closure.
- Perfect for cold drinks such as water, lemonade, juice, bleeding, etc. Ideal for buffet, meetings area, hotels receptions, etc.
- Great opening that facilitates its filling and cleaning. Capacity of 5.5 L.
- Jug suitable for dishwasher.



Jarra Dispensadora  
Pichet distributeur de boissons · Getränkespender  
Serving pitcher · Jarra dispensadora

Ref	€	cm	h (cm)	L	U.Venta
A 61951	22,80	18x23	30,5	5,50	1
B 61955	7,90	19,5	18,5	-	1
C 61956	13,60	21,0	14,5	-	1





- Cuerpo fabricado en plástico y tapa en polipropileno.
- Libre de bpa.
- Tapa antiderrames para verter sin ningún problema.
- Filtro infusor en el centro para frutas y verduras.
- Fácil de usar y perfecta para un estilo de vida saludable.

- Corps en plastique et couvercle en polypropylène.
- Sans BPA.
- Couverture antiderram à verser sans aucun problème.
- Filtre de perfusion dans le centre des fruits et légumes.
- Facile à utiliser et parfait pour un mode de vie sain.

- Body made of plastic and lid in polypropylene.
- BPA free.
- Antiderram cover to pour without any problem.
- Infusionary filter in the fruits and vegetable center.
- Easy to use and perfect for a healthy lifestyle.



PP  
Polypropylene  
Dishwasher  
BPA free

**Jarra Infusora Clear**  
Pichet infuseur · Tee-Zubereiter  
Infusion pitcher · Jarra infusionadora

Ref	€	cm	L	U.Venta
61954	31,60	19x16x29	2,40	1

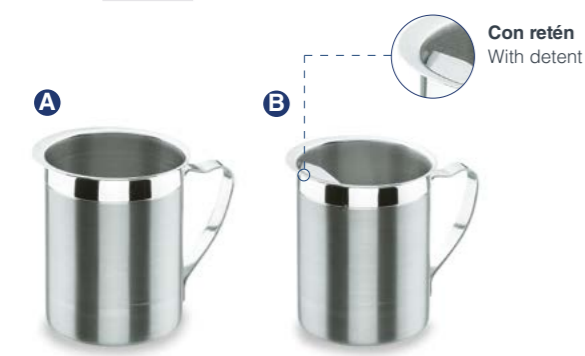

Con retén  
With detent

INOX  
18/10

**Jarra de agua Inox**  
Pot à eau · AcrylKrug  
Water pitcher · Jarra

Ref	€	Ø (cm)	L	U.Venta
62716	26,00	12x16	1,50	1
62721	28,70	12x23	2,00	1
62726	33,10	12x26,5	2,50	1
62715	30,20	12x16	1,50	1
62720	31,50	12x23	2,00	1
62725	35,60	12x26,5	2,50	1

**Jarra de agua abombada**  
Pot à eau bombée · Wasserkanne  
Rounder water pitcher · Jarra bojuda

Ref	€	L	U.Venta
62702	49,20	2,00	1

ASA  
Acrylic  
Dishwasher  
BPA free

**Jarra de agua Clear**  
Pot à eau · AcrylKrug  
Water pitcher · Jarra

Ref	€	L	U.Venta
62392	14,30	2,00	1
62393	18,10	3,00	1



## Vasos



Dishwasher

- Fabricados en trítan transparente libre de BPA; material muy resistente que soporta altas temperaturas.
- Ligeros, versátiles y a prueba de roturas, perfectos para espacios exteriores donde la seguridad es importante.
- Para servir y disfrutar todo tipo de bebidas en cualquier ocasión.
- Su gran parecido visual al vidrio hace que sea sutil, elegante y de calidad, como un vaso de vidrio.
- Reutilizables, irrompibles.

- Fabriqué dans un Tritan transparent sans BPA; Matériau très résistant qui prend en charge des températures élevées.
- Proof léger, polyvalent et brisé, parfait pour les espaces extérieurs où la sécurité est importante.
- Servir et profiter de toutes sortes de boissons à n'importe quelle occasion.
- Sa grande ressemblance visuelle avec le verre le rend subtil, élégant et de qualité, comme un verre en verre.
- Réutilisable, incassable.

- Manufactured in transparent tritan free of BPA; Very resistant material that supports high temperatures.
- Light, versatile and breakage proof, perfect for outdoor spaces where security is important.
- To serve and enjoy all kinds of drinks on any occasion.
- Its great visual resemblance to glass makes it subtle, elegant and quality, like a glass glass.
- Reusable, unbreakable,



TRITAN  
Plastic  
BPA free

### Set 6 vasos Tritán

Set 6 verres · Set 6 gläser  
Set of 6 glasses · Conjunto de 6 copos

	Ref	€	ml	Ø (cm)	h(cm)	U.Venta	
A	63141	33,90	400	8,5	9,5	1	Whisky · Whisky
B	63143	46,50	350	7	20	1	Vino blanco · White wine
C	63144	52,80	500	9,5	21	1	Vino tinto · Red wine
D	63146	63,60	500	8,5	14	1	Cerveza · Beer
E	63147	50,20	350	8,0	10	1	Agua · Water
F	63148	36,00	300	6,5	11	1	Vaso para niño · Child glass
G	63149	52,40	150	4,5	22,5	1	Champán · Champagne

MF  
Melamine  
BPA free

**Vaso Melamina**  
Timbale · Trinkbecher  
Tumbler · Copo

	Ref	€	L	Ø (cm)	h(cm)	U.Venta
A	63350	3,50	0,32	7,3	7,7	1
B	63351	3,50	0,32	7,3	7,7	1

INOX  
18/10  
Dishwasher

**Vaso Inox**  
Timbale · Trinkbecher  
Tumbler · Copo

	Ref	€	L	Ø (cm)	h (cm)	U.Venta
	62406	6,20	0,30	7,5	10,0	1



# Soporte Copas

FE Iron CRO Cromado Chrome

- Soporte que permite ahorrar espacio y almacenar las copas de forma ordenada.
- Se fija a la parte superior de un mueble, techo o cornisa permitiendo colocar las copas boca abajo y facilitando accesibilidad de las mismas.
- Desliza las copas muy fácilmente evitando que se marquen y que se rompan.

- Support qui permet d'économiser de l'espace et de stocker les lunettes de manière ordonnée.
- Il est fixé au sommet d'un mobilier, d'un toit ou d'une corniche permettant de placer les verres face vers le bas et de faciliter leur accessibilité.
- Faites glisser les verres qui les empêchaient très facilement d'être marqués et se briser.

- Support that allows saving space and storing the glasses in an orderly manner.
- It is fixed to the top of a furniture, roof or cornice allowing to place the glasses face down and facilitating their accessibility.
- Slide the glasses very easily preventing them from being marked and breaking.

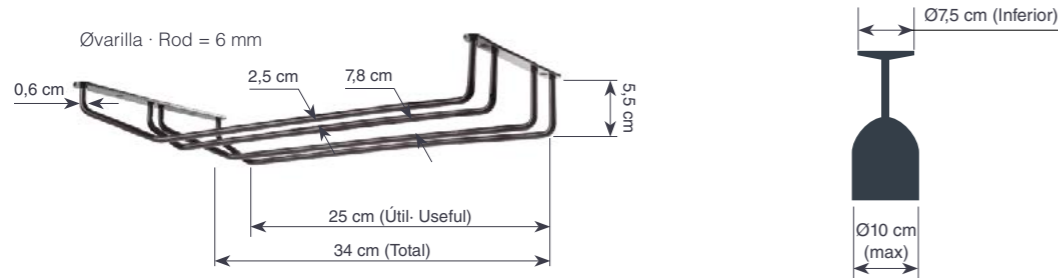

## Soporte de copas Inox

Support à coupes · Gläserhalter  
Cups stand · Suporte de tapas

	Ref	€	cm	h(cm)	U.Venta
<b>A</b>	62261	15,30	34x10	6	1
<b>B</b>	62262	22,40	34x20	6	1
<b>C</b>	62263	34,40	34x40	6	1



## Soporte de Copas Black

Support à coupes · Gläserhalter  
Cups stand · Suporte de tapas

	Ref	€	cm	h(cm)	U.Venta
<b>A</b>	62264	17,80	34x10	6	1
<b>B</b>	62265	27,30	34x20	6	1
<b>C</b>	62266	38,40	34x40	6	1



**No requiere instalación**  
Recubrimiento de silicona, no raya  
No installation required  
Silicone coating, does not scratch

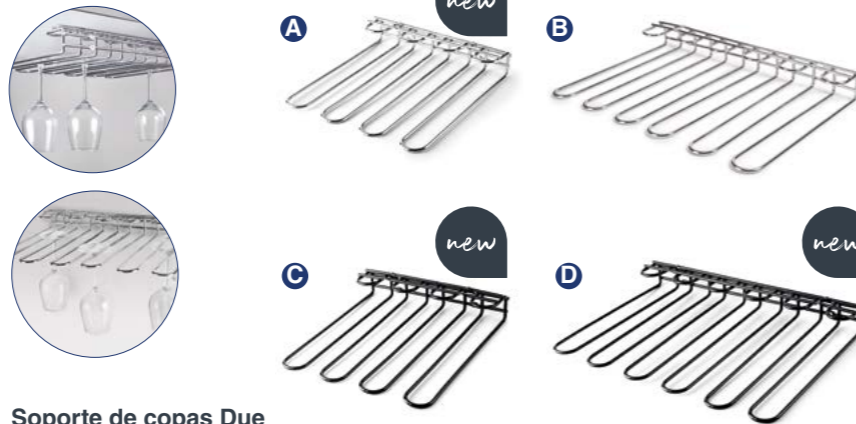

## Soporte de copas Due

Support à coupes · Gläserhalter  
Cups stand · Suporte de tapas

	Ref	€	cm	h(cm)	Capacidad	U.Venta
<b>A</b>	62254	12,30	29x31,5	5,0	12 copas	1
<b>B</b>	62268	19,20	45x32	6,0	20 copas	1
<b>C</b>	62253	12,30	29x31,5	5,00	12 copas	1
<b>D</b>	62255	19,20	45x32	6,00	20 copas	1

## Soporte de copas Tri

Support à coupes · Gläserhalter  
Cups stand · Suporte de tapas

Ref	€	cm	Capacidad	U.Venta
62267	18,60	31x21	6 copas	1



# Coctelería

INOX 18/10 INOX PP Polypropylene Dishwasher BPA free

- Todo lo necesario para preparar deliciosos cócteles.
- Ideal para profesionales de la coctelería.
- Podrá encontrar cocteleras, pinzas para hielo, vasos medidores, cucharas de bar, etc.

- Tout ce dont vous avez besoin pour préparer de délicieux cocktails.
- Idéal pour les mixologues professionnels.
- Vous pouvez trouver des shakers, pinces à glace, verres à mesurer, cuillères de bar, etc.

- Everything you need to prepare delicious cocktails.
- Ideal for professional mixologists.
- You can find cocktail shakers, ice tongs, measuring glasses, bar spoons, etc.

Compuesto por:

- A** Cucharilla cocktail
- B** Coctelera
- C** Maza mojito
- D** Colador gusanillo
- E** Sacacorchos
- F** Dosificador licor
- G** Pinza
- H** Tapón
- I** Dos boquillas servidoras
- J** Soporte

Compuesto por:

- A** Cucharilla cocktail
- B** Coctelera
- C** Maza mojito
- D** Colador gusanillo
- E** Pinza
- F** Dosificador licor
- G** Dos boquillas servidoras



## Juego coctelería Inox

Ensemble pour cocktails · Cocktail-Utilensilien  
Cocktail Set · Conjunto para preparar cocktails

Ref	€	Piezas	U.Venta
62181	61,40	10	1

TPE Plastic Dishwasher

## Tapete para coctelería

Tapis pour égouttoir · Cocktail-Matte  
Cocktail mat · Tapete para cocktails

	Ref	€	cm	h(cm)	U.Venta
<b>A</b>	62626	17,90	45x30	1,80	20
<b>B</b>	62627	11,00	30x15	1,80	20
<b>C</b>	62628	11,00	60x8	1,80	20

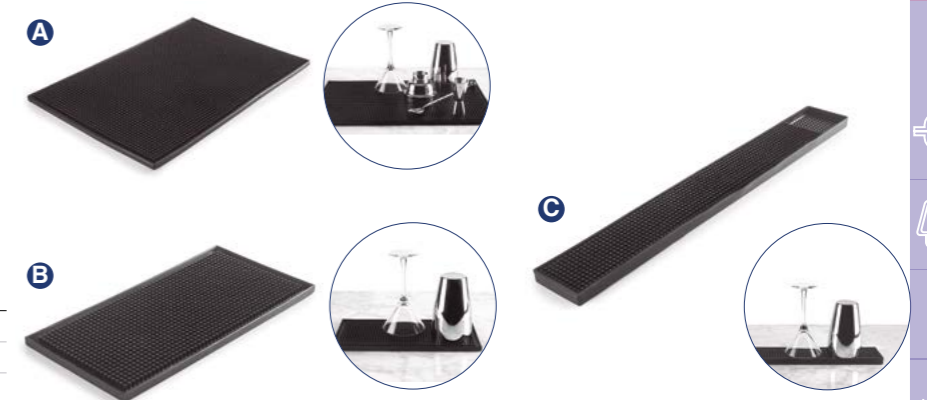

## Juego coctelería Inox cobre

Ensemble pour cocktails · Cocktail-Utilensilien  
Cocktail Set · Conjunto para preparar cocktails

Ref	€	Piezas	U.Venta
62182	57,50	8	1





Perfecto para organizar utensilios y accesorios de coctelería y bar como servilletas, pajitas, adornos, etc. Puede contener aproximadamente 100 servilletas de 12x12 cm

Perfect for organising cocktail utensils and accessories and bar such as napkins, straws and decorations. It holds around 100 12x12 cm cocktail napkins

6 Compart.



ABS Plastic Dishwasher

### Organizador de accesorios cóctel

Organisateur pour accessoires de cocktail · Organizer für Cocktailzubehör  
Cocktail accessory organiser · Organizador de acessórios para cocktails

Ref	€	cm	h(cm)	Compartimentos	U.Venta
62438	9,70	24x14	10	6	1

Diseno Vintage



INOX 18/10 Dishwasher

### Taza Moscow Mule

Tasse · Tassen  
Cup · Copo

Ref	€	ml	Ø (cm)	h(cm)	U.Venta
A 62184	10,30	480	9	9	1
B 62185	10,30	550	9	10	1



Ideal para dar un toque especial a los cócteles. Consigue un efecto de hielo o escarcha

Perfect for adding a special touch to your cocktails. Create a frosty or icy effect

3 Compart.

Almohadilla para zumo  
Pad for juice



ABS Plastic Dishwasher

### Ribeteador de copas y vasos

Sucreur/saleur bordeur de verres · Umranden für Cocktailgläser  
Glass rimmer · Decorador de copos e taças

Ref	€	cm	h(cm)	Bandejas	U.Venta
62414	14,30	20x16	7,5	3	1

- Fabricadas en acero inoxidable 18/10 de alta calidad.
- Revestimiento exterior cobre mate.
- Ideal para preparar el clásico cóctel de vodka "Moscow Mule", (62184/62185), cóctel de menta "Mint Juel" (62187), cócteles o cualquier tipo de bebida frías.
- Mantiene las bebidas frías por más tiempo gracias a su alta conductividad térmica.
- Borde de acero encapsulado reforzado.
- Mango ergonómico fabricado en acero inoxidable (62184/62185).
- Fácil limpieza: Se recomienda lavar a mano y secar a fondo. No apto para el lavavajillas.

- Fabriquée en acier inoxydable 18/10 de grande qualité.
- Revêtement extérieur en cuivre mat.
- Idéales pour préparer le traditionnel cocktail de menthe « Moscow Mule », (62184/62185), cocktail de menthe « Mint Juel », (62187), ainsi que tout type de cocktail ou de boisson froide.
- Gardent les boissons fraîches plus longtemps.
- Bord en acier encapsulé renforcé.
- Poignée ergonomique en acier inoxydable (62184/62185).
- Nettoyage facile : Il est recommandé de les laver à la main et de parfaitement bien les sécher. Ne pas mettre au lave-vaisselle.

- Made of high quality 18/10 stainless steel.
- Matte copper outer finish.
- Perfect for making the classic "Moscow Mule" vodka cocktail (62184/62185), Mint Juel mint cocktail (62187), other cocktails or any kind of cold drink.
- Keeps drinks cold longer because of their high thermal conductivity.
- Reinforced encapsulated steel edge. Ergonomic handle made of stainless steel.
- Ergonomic handle made of stainless steel (62184/62185).
- Easy to clean: Hand washing and thorough drying is recommended. Not dishwasher safe.



INOX 18/10 Dishwasher

### Vaso Julep Mug

Timbale · Trinkbecher  
Tumbler · Copo

Ref	€	ml	h(cm)	U.Venta
62187	10,30	350	10	1

new



INOX VIDRIO Glass Dishwasher

### Coctelera Boston

Agitateur · Cocktailshaker  
Cocktail shaker · Agitador

Ref	€	Ø (cm)	h(cm)	U.Venta
A 62285	14,30	8	16	1
B 62286	18,70	8	16	1

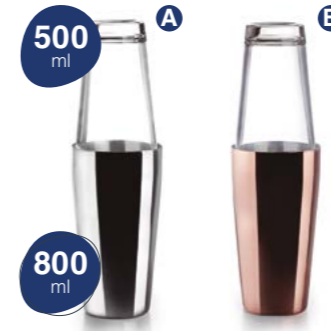

INOX 18/10 ASA Acrylic Dishwasher BPA free

### Coctelera Acrylic

Agitateur · Cocktailshaker  
Cocktail shaker · Agitador

Ref	€	Ø (cm)	h(cm)	ml	U.Venta
62388	21,20	9	22,5	450	1



INOX 18/10 BAMBOO Dishwasher

### Cubitera Nordic

Seau à glace · Sektkühler  
Ice bucket · Porta-cubos gelo

Ref	€	Ø (cm)	h(cm)	L	U.Venta
65514	32,90	14	14,5	1,30	1



### Librador Inox

Pelle à farine · Mehlshaufel  
Ice shovel · Corredor

Ref	€	ml	Largo (cm)	Ancho (cm)	U.Venta
67012	17,90	60	19,0	5,0	6
67013	20,80	110	21,5	6,0	6
67014	24,60	200	24,0	7,0	6
67016	27,30	260	25,5	8,5	1
67017	30,30	360	29,0	10,0	6
67018	32,70	470	31,0	11,0	6
67019	40,70	640	35,0	12,5	6
67020	48,70	860	38,0	14,0	6



### Coctelera Inox

Agitateur · Cocktailshaker  
Cocktail shaker · Agitador

Ref	€	L	U.Venta
623031	52,20	0,50	1
623041	61,90	0,75	1



INOX 18/10 Dishwasher BPA free

### Picadora de hielo manual

Broyeur à glace manuel · Manuel Eis-Crusher  
Manual ice crusher · Picadora de gelo manual

Ref	€	cm	h(cm)	U.Venta
60327	50,60	16x23	12	1



ASA Acrylic Dishwasher BPA free

### Cubitera Clear

Seau à glace · Sektkühler  
Ice bucket · Porta-cubos gelo

Ref	€	Ø (cm)	h(cm)	L	U.Venta
62363	26,50	20	21	3,00	1



PC Polycarbonate Dishwasher BPA free

### Librador

Pelle à farine · Mehlshaufel  
Ice shovel · Corredor

Ref	€	ml	U.Venta
A 67021	5,90	170	1
B 67022	11,90	900	1
C 67023	16,30	1800	1





### Pinza de hielo Nord

Pince à glace · Eiszange  
Ice tong · Pinça de gelo

Ref	€	Largo (cm)	U.Venta
62306	4,70	18,5	12



### Pinza de hielo Luxe

Pince à glace · Eiszange  
Ice tong · Pinça de gelo

Ref	€	Largo (cm)	U.Venta
62337	10,20	20	12



### Colador gusanillo

Passoire à cocktail · Cocktailsieb  
Cocktail strainer · Coador batidos

Ref	€	Ø (cm)	U.Venta
62326	24,20	7,5	1



PP  
Polypropylene  
BPA free

### Maza negra mojito

Pilon noir mojito · Mojitostößel  
Black mace mojito · Maço preto mojito

Ref	€	Largo (cm)	U.Venta
62278	11,50	18	1
62279	13,00	26	1



### Cucharilla Coctail

Cuillère cocktail · Barlöffel  
Cocktail spoon · Colher cocktail

Ref	€	Largo (cm)	U.Venta
A 62302	4,80	27	6
B 62352	8,30	28	6



### Dosificador licor Dual

Mesure à cocktail · Cocktailmass  
Jigger · Dosificador licor

Ref	€	cl	h(cm)	U.Venta
A 62329	22,40	2-2,5 / 4-5	9,7	1
B 62330	20,60	2 / 4	9,7	1

# Vinoteca



INOX

### Descapsulador Rond

Coupe capsule · Folien cutter  
Foil cutter · Descapsulador

Ref	€	Ø (cm)	U.Venta
63137	4,90	6	12



INOX

### Anilla antigoteo

Anneau stop gouttes à vin · Weinring Trop-Stop  
Wine drip stop ring · Anilha anti-gota

Ref	€	Ø (cm)	U.Venta
63019	3,20	5	12



INOX

SI  
Silicone



### Boquilla servidora + tapón

Bec verseur + bouchon · Ausgiess-Aufsatz mit Verschluss  
Spout for wine + rubber cap · Boquilha de servir + tampão

Ref	€	U.Venta
63022	4,50	12



SI  
Silicone



### Aireador de vino

Aérateur de vin · Weinbelüfter  
Wine aerator · Arejador de vinho

Ref	€	U.Venta
63048	2,90	1



### Dispensador de líquidos Bar-Butler

Distributeur de boissons alcoolisées · Spirituosenspender  
Liquor dispenser · Dispensador de bebidas

Ref	€	L	U.Venta
62341	95,20	4 cl	1



### Botella sifón CO2

Bouteille siphon · Soda-Siphon  
Soda maker bottle · Garrafa armadilha

Ref	€	Ø (cm)	L	U.Venta
68601	56,40	10x39	1,00	1



### Cargas para botellas sifón CO2

Cartuches CO2 pour siphon · CO2-Kapsen für Siphon  
CO2 soda charges · Botijas de sifão CO2

Ref	€	Botellas	g	U.Venta
68602	8,20	10	8	1

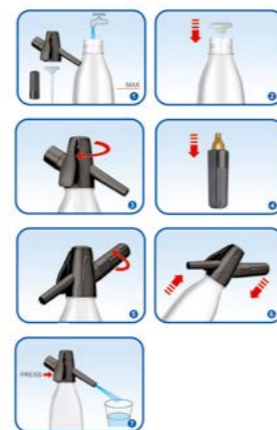

Conserva durante más tiempo el frescor y el sabor del champán o cava  
Conserve the freshness and flavour of Champagne or Cava for longer

PP  
Polypropylene

INOX



### Tapón champán

Bouchon de champagne · Sektflaschenverschluss  
Campagne cap · Tampão champagne

Ref	€	Ø (cm)	h(cm)	U.Venta
A 63021	7,30	4,5	4,5	1
B 63055	8,20	3,8	3,5	1



Innox



Copper



Bloqueo rotativo  
Rotary lock

# Sacacorchos



- **Diseño elegante, moderno y ergonómico: ideal para su uso profesional y de hogar.**
- **Funcionamiento rápido y sencillo tan solo pulsando un botón.**
- **Facilita la extracción del corcho de cualquier botella de vino en tan solo 6-8 segundos.**
- **Extrae el corcho suavemente y de forma silenciosa.**
- **Cabezal de extracción con iluminación led.**
- **Indicador de batería luminoso mediante LED: 4 niveles para indicar el nivel de energía.**
- **Se carga mediante cable Micro USB.**
- **Incluye: cable cargador USB y descapsulador.**

- Design élégant, moderne et ergonomique: idéal pour un usage professionnel et à domicile.
- Fonctionnement rapide et simple simplement en appuyant sur un bouton.
- Il facilite l'extraction du bouchon de n'importe quelle bouteille de vin en seulement 6 à 8 secondes.
- Extraire le liège doucement et silencieusement.
- Tête d'extraction avec éclairage LED.
- Indicateur de batterie LED Utilisation de LED: 4 niveaux pour indiquer le niveau d'énergie.
- Il est chargé par un câble micro USB.
- Comprend: câble de chargeur USB et décapsules.

- Elegant, modern and ergonomic design: ideal for professional and home use.
- Fast and simple operation just by pressing a button.
- It facilitates the extraction of the cork of any wine bottle in just 6-8 seconds.
- Extract the cork gently and silently.
- Extraction head with LED lighting.
- LED battery indicator using LED: 4 levels to indicate the energy level.
- It is loaded by micro USB cable.
- Includes: USB charger cable and decapsulator.



Autonomía  
Battery life  
**30-40**  
Botellas  
Bottles



## Sacacorchos eléctrico Black Luxe

Tire bouchon électrique · Korkenzieher, elektrisch  
Electric corkscrew · Saca-rolhas eléctrico

Ref	€	Ø (cm)	h(cm)	U.Venta
63056	39,30	4,8	22	1



Autonomía  
Battery life  
**30-40**  
Botellas  
Bottles



## Sacacorchos eléctrico Black

Tire bouchon électrique · Korkenzieher, elektrisch  
Electric corkscrew · Saca-rolhas eléctrico

Ref	€	Ø (cm)	h(cm)	U.Venta
63057	30,40	5	19	1



Autonomía  
Battery life  
**30**  
Botellas  
Bottles



## Sacacorchos eléctrico AutoPro

Tire bouchon électrique · Korkenzieher, elektrisch  
Electric corkscrew · Saca-rolhas Eléctrico

Ref	€	cm	U.Venta
63031	41,80	Ø12x32	1



Autonomía  
Battery life  
**30-40**  
Botellas  
Bottles



## Sacacorchos eléctrico Smart

Tire bouchon électrique · Korkenzieher, elektrisch  
Electric corkscrew · Saca-rolhas Eléctrico

Ref	€	cm	U.Venta
63054	44,90	Ø5x25	1



## Sacacorchos profesional Automatic

Tire-bouchon professionnel · Profi-Entkorker  
Professional corkscrew · Saca-rolhas professional

Ref	€	U.Venta
A 63010	333,10	1
B 63012	346,60	1



ZAMAK  
Zinc Alloy

## Sacacorchos Black

Tire-bouchon · Korkenzieher  
Zinc alloy corkscrew · Saca-rolhas

Ref	€	U.Venta
63028	47,10	1



ZAMAK  
Zinc Alloy

## Sacacorchos Vin

Tire-bouchon · Korkenzieher  
Zinc alloy corkscrew · Saca-rolhas

Ref	€	U.Venta
63013	17,80	1



ZAMAK  
Zinc Alloy

## Sacacorchos Classic

Tire-bouchon · Korkenzieher  
Zinc alloy corkscrew · Saca-rolhas

Ref	€	U.Venta
63047	10,30	1

**Multifunción 3 en 1:**  
sacacorchos + abridor de botellas  
+ cuchilla corta cápsulas  
Multi-purpose: 3 in 1:  
corkscrew + bottle opener+ capsule cutter



INOX

## Sacacorchos camarero Duo

Tire-bouchon limonadier · Kellnerkorkenzieher  
Waiter's corkscrew · Saca-rolhas con navalha

Ref	€	U.Venta
63018	5,40	6



**Multifunción 3 en 1**  
Multi-purpose: 3 in 1

INOX

## Sacacorchos camarero Luxe

Tire-bouchon limonadier · Kellnerkorkenzieher  
Waiter's corkscrew · Saca-rolhas con navalha

Ref	€	U.Venta
63044	5,20	1

Acabado en mate negro  
Matte black finish



**Multifunción 3 en 1**  
Multi-purpose: 3 in 1

INOX

RUBBER WOOD

## Sacacorchos camarero Madera

Tire-bouchon limonadier · Kellnerkorkenzieher  
Waiter's corkscrew · Saca-rolhas con navalha

Ref	€	U.Venta
63046	7,70	1

Acabado en mate negro  
Matte black finish

# Bomba de vacío



- Conserva el vino en perfecto estado manteniendo todo su sabor y aroma durante más tiempo.
- Extrae el aire acumulado en el interior de la botella y retrasa el proceso de oxidación.
- Cierra la botella con el tapón y bombea de 10 a 20 veces (dependiendo de la cantidad de vino que haya dentro de la botella) para establecer el vacío.
- Incluye bomba de vacío y dos tapones (con indicador de la fecha en la que se ha sellado la botella).

- Gardez le vin en parfait état en gardant toute sa saveur et son arôme plus longtemps.
- Extraire l'air accumulé à l'intérieur de la bouteille et retarder le processus d'oxydation.
- Fermez la bouteille avec le capuchon et pompez 10 à 20 fois (selon la quantité de vin à l'intérieur de la bouteille) pour établir le vide.
- Comprend une pompe à vide et deux capuchons (avec indicateur de la date à laquelle la bouteille a été scellée).

- Keep the wine in perfect condition keeping all its flavor and aroma for a longer time.
- Extract the accumulated air inside the bottle and delay the oxidation process.
- Close the bottle with the cap and pump 10 to 20 times (depending on the amount of wine inside the bottle) to establish the void.
- Includes vacuum pump and two caps (with indicator of the date on which the bottle has been sealed).

PP  
Polypropylene

**Bomba de vacío Keep**  
Pompe à vide · Weinpumpe  
Vacuum pump · Bomba de vacío

INOX SI ABS  
Stainless Steel Silicone Plastic

**Bomba de vacío Inox**  
Pompe à vide · Weinpumpe  
Vacuum pump · Bomba de vacío

Ref	€	U.Venta	Ref	€	U.Venta
63051	9,10	1	63033	11,50	1
A R63051A	2,40	1	A R63033	3,20	1

# Vitrinas expositoras



**Protección contra posibles contaminaciones**  
Protection against food contaminants



**Tapa Roll-Top (Plegable)**  
Roll-Top Lid (Folding)

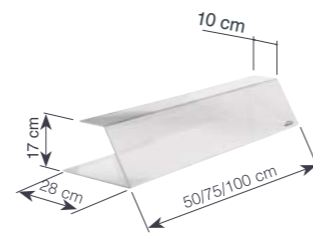

ASA  
Acrylic



**Vitrina expositora Bar**

Vitrine de présentation pour bar · Tisch-Vitrine Gaststätte  
Bar display Case · Vitrina expositora para bar

Ref	€	cm	e (mm)	U.Venta
39450	58,20	50x28x17	5	1
39445	86,10	75x28x17	5	1
39441	122,10	100x28x17	5	1

PC  
Polycarbonate



**Tapa expositora GN 1/1**

Couvercle de présentation GN 1/1 · Rolltop-Haube  
GN 1/1 display Case Lid · Expositor com tampa GN 1/1

Ref	€	cm	GN	U.Venta
66907P	37,70	53x32,5	GN 1/1	1

Un total de 5 modelos de vitrinas neutras, calientes y refrigeradas, diseñadas especialmente para presentar y exponer todo tipo de alimentos, y garantizando siempre la calidad y conservación de estos.

There are 5 models of neutral, warm and refrigerated display cases especially designed to present and display all kinds of food and ensure its quality and conservation at all times.



CRISTAL INOX  
Glass

**Vitrina neutra**

Vitrine neutre · Einfache vitrine  
Clear countertop display case · Vitrina neutra

Ref	€	Capacidad	h(cm)	Medidas	U.Venta
69601	293,10	45L	37	56x37,6x37 cm	1

- Vitrina neutra construida íntegramente en cristal y base de acero inoxidable.
- Diseñada para presentar y exponer sobre la barra / mostrador.
- Superficie superior curvada para una visión panorámica.
- Estante intermedio de cristal templado.
- Puerta trasera abatible.
- 4 pies de goma que garantizan máxima estabilidad.

- Vitrine neutre construite entièrement dans une base en verre et en acier inoxydable.
- Conçu pour présenter et exposer sur la barre / comptoir.
- Surface supérieure incurvée pour une vue panoramique.
- Étagère en verre trempé intermédiaire.
- Porte arrière pliante.
- 4 pieds en caoutchouc qui garantissent une stabilité maximale.

- Neutral showcase built entirely in glass and stainless steel base.
- Designed to present and expose on the bar / counter.
- Curved upper surface for a panoramic view.
- Intermediate tempered glass shelf.
- Folding rear door.
- 4 rubber feet that guarantee maximum stability.

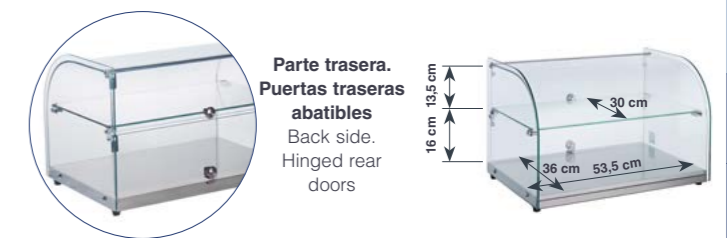

**Parte trasera. Puertas traseras abatibles**  
Back side. Hinged rear doors

- Vitrina térmica fabricada en acero inoxidable y cristal.
- Diseñada para conservar, presentar y exponer sobre la barra / mostrador.
- Puerta trasera abatible.
- Superficie superior inclinada para una visión panorámica.
- Recipiente de agua extraíble que aporta humedad en la cámara.
- Termostato de control de temperatura regulable: 30-90°C.
- Bandeja de rejilla extraíble que facilita el lujo del calor.

IPX4

- Vitrine thermique fabriquée en acier inoxydable et en verre.
- Conçu pour conserver, présenter et exposer sur la barre / comptoir.
- Porte arrière pliante.
- Supérieur submergé pour une vue panoramique.
- Récipient d'eau amovible qui apporte l'humidité dans la chambre.
- Thermostat de commande de température réglable: 30-90°C.
- Plateau de grille amovible qui facilite le luxe de la chaleur.

- Thermal showcase manufactured in stainless steel and glass.
- Designed to conserve, present and expose on the bar / counter.
- Folding rear door.
- Superior overwhelmed for a panoramic view.
- Removable water container that brings moisture in the chamber.
- Adjustable temperature control thermostat: 30-90°C.
- Removable grid tray that facilitates the luxury of heat.



CRISTAL INOX  
Glass

**Vitrina térmica**

Vitrine thermique · Warmhaltevitrine  
Thermal display case · Vitrina térmica

Ref	€	W	Capacidad	Temperatura	Protección	Medidas	U.Venta
69604	592,80	800	45L	30°C-90°C	IPX4	55,5x37,5x37 cm	1



**Parte trasera. Puertas traseras abatibles**  
Back side. Hinged rear doors



4  
Cubetas  
Containers

- Vitrina térmica fabricada en acero inoxidable y cristal.
- Diseñada para conservar, presentar y exponer sobre la barra / mostrador.
- Puertas correderas para una accesibilidad total.
- Superficie superior curvada para una visión panorámica.
- Cubetas gastronorm 1/3 incluidas.
- Termostato de control de temperatura regulable: 30 - 90°C.

- Vitrine thermique fabriquée en acier inoxydable et en verre.
- Conçu pour conserver, présenter et exposer sur la barre / comptoir.
- Portes coulissantes pour l'accessibilité totale.
- Superficie supérieure incurvée pour une vue panoramique.
- Cubetas Gastronorm 1/3 inclus.
- Thermostat de commande de température réglable: 30 - 90 ° C.

- Thermal showcase manufactured in stainless steel and glass.
- Designed to conserve, present and expose on the bar / counter.
- Sliding doors for total accessibility.
- Superficie Curvada superior for a panoramic view.
- Gastronorm 1/3 trays included.
- Adjustable temperature control thermostat: 30 - 90°C.



IPX4

Parte trasera.  
Puertas traseras correderas.  
4 / 6 cubetas gastronorm 1/3 incluidas  
Back side.  
Sliding rear doors.  
4/6 Gastronorm 1/3 trays included

INOX CRISTAL  
Glass

### Vitrina térmica GN

Vitrine thermique · Warmhaltevitrine  
Thermal display case · Vitrina térmica

	Ref	€	W	Capacidad	Temperatura	Protección	Medidas	U.Venta
A	69602	653,60	500	4x GN 1/3	30°C-90°C	IPX4	77,5x42x33,5 cm	1
B	69603	751,40	800	6x GN 1/3	30°C-90°C	IPX4	113x42x33,5 cm	1



Parte trasera  
Back side



- Vitrina refrigerada construida íntegramente en cristal y acero inoxidable.
- Diseñada para conservar, presentar y exponer sobre la barra / mostrador.
- Puertas correderas para una accesibilidad total.
- Superficie superior inclinada para una visión panorámica.
- Sistema de enfriamiento por compresor. Función Defrost.
- Termostato de control de temperatura regulable: 2-12°C.
- Sist. de iluminación LED en la cámara interior y display de control de mandos.

- Vitrine réfrigérée construite entièrement en verre et en acier inoxydable.
- Conçu pour conserver, présenter et exposer sur la barre / comptoir.
- Portes coulissantes pour l'accessibilité totale.
- Surface supérieure inclinée pour une vue panoramique.
- Système de refroidissement du compresseur. Fonction de dégivrage.
- Thermostat de commande de température réglable: 2-12°C.
- Sist. d'éclairage LED dans la chambre intérieure et le contrôle des commandes.

- Refrigerated showcase built entirely in glass and stainless steel.
- Designed to conserve, present and expose on the bar / counter.
- Sliding doors for total accessibility.
- Inclined upper surface for a panoramic view.
- Compressor cooling system. Defrost function.
- Adjustable temperature control thermostat: 2-12°C.
- Sist. of LED lighting in the inner chamber and control of controls.

CRISTAL INOX  
Glass

### Vitrina refrigerada

Vitrine réfrigérée · Kühlvitrine  
Refrigerated display case · Vitrina refrigerada

	Ref	€	W	Capacidad	Temperatura	Refrigerante	Medidas	U.Venta
	69607	1113,60	105	40L	2-12°C	R600a	68x58x34 cm	1



4  
Cubetas  
Containers



6  
Cubetas  
Containers

- Vitrina refrigerada construida íntegramente en cristal y acero inoxidable.
- Diseñada para conservar, presentar y exponer sobre la barra / mostrador.
- Puertas correderas para una accesibilidad total.
- Superficie superior curvada para una visión panorámica.
- Sistema de enfriamiento por compresor.
- Cubetas gastronorm 1/3 incluidas.
- Termostato de control de temperatura regulable: 0-12°C.
- Sistema de iluminación LED en la cámara interior y display de control de mandos.

- Vitrine réfrigérée construite entièrement en verre et en acier inoxydable.
- Conçu pour conserver, présenter et exposer sur la barre / comptoir.
- Portes coulissantes pour l'accessibilité totale.
- Surface supérieure incurvée pour une vue panoramique.
- Système de refroidissement du compresseur.
- Cubetas Gastronorm 1/3 inclus.
- Thermostat de commande de température réglable: 0-12°C.
- Système d'éclairage LED dans l'écran de commande de la chambre intérieure et de la commande.

- Refrigerated showcase built entirely in glass and stainless steel.
- Designed to conserve, present and expose on the bar / counter.
- Sliding doors for total accessibility.
- Curved upper surface for a panoramic view.
- Compressor cooling system.
- Gastronorm 1/3 trays included.
- Adjustable temperature control thermostat: 0-12°C.
- LED lighting system in the inner chamber and control control display.



Control de temperatura  
regulable  
Temperature control thermostat

Puertas traseras correderas  
Sliding rear doors

INOX CRISTAL  
Glass

### Vitrina refrigerada GN

Vitrine réfrigérée · Kühlvitrine  
Refrigerated display case · Vitrina refrigerada

	Ref	€	W	Capacidad	Temperatura	Refrigerante	Medidas	U.Venta
A	69605	1270,50	160	4x GN 1/3	0°C-12°C	R600a	112,1x45x33 cm	1
B	69606	1408,60	160	6x GN 1/3	0°C-12°C	R600a	148,3x45x33 cm	1

69602

Combinaciones posibles  
Possible combinations

GN 2/3	GN 2/3
--------	--------

GN 1/3	GN 1/3	GN 1/3	GN 1/3
--------	--------	--------	--------

69603

Combinaciones posibles  
Possible combinations

GN 2/3	GN 2/3	GN 2/3
--------	--------	--------

GN 1/2	GN 1/2	GN 1/2	GN 1/2
--------	--------	--------	--------

GN 1/3	GN 1/3	GN 1/3	GN 1/3	GN 1/3	GN 1/3
--------	--------	--------	--------	--------	--------

04

Repostería  
Pastry

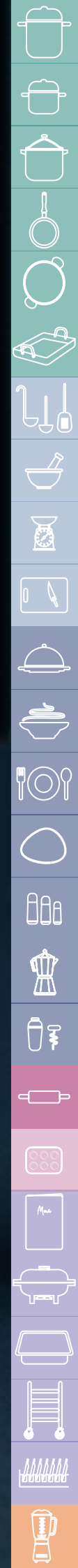

# Jarras medidoras

INOX 18/10  
Dishwasher



**Jarra medidora Inox**  
Pot mesureur · Mass Behälter  
Measuring jug · Jarra de medidas

Ref	€	Ø (cm)	L	U.Venta
62750	<b>77,90</b>	17x22,5	5,00	1

**Jarra medidora**  
Couvercle · Deckel  
Lid · Tampa



Ref	€	Ø (cm)	h(cm)	L	U.Venta
62741	<b>22,40</b>	11,5	13,0	1,0	1
62742	<b>26,50</b>	15,0	17,0	2,0	1

VIDRIO  
Glass  
Microwave



**Jarra medidora Cristal**  
Pot mesureur · Mass Behälter  
Measuring jug · Jarra de medidas

Ref	€	L	U.Venta
67133	<b>11,30</b>	0,5	1

SAN  
Plastic  
BPA free



**Set 3 jarras medidoras Tri**  
Ensemble de 3 pot mesureur · 3-tlg. Satz Messbecher  
3 piece measuring jugs · Jogo 3 jarras de medidas

Ref	€	L	U.Venta
67131	<b>15,60</b>	0,25	1
		0,5	
		1,0	

PMMA  
Plastic  
BPA free



**Vaso medidor Basic**  
Verre doseur · Messbecher  
Measuring cup · Copo medidor

Ref	€	Ø (cm)	h(cm)	L	U.Venta
67075	<b>7,60</b>	8,5	16,0	0,5	1
67071	<b>9,90</b>	10,5	19,0	1,0	1

PP  
Polypropylene  
BPA free



**Set 3 jarras medidoras**  
Set 3 pichets doseurs · Messbecher, 3 Er-Set  
Set of 3 measuring jugs · Conjunto 3 jarras medidas

Ref	€	Ø (cm)	h(cm)	L	U.Venta
67130	<b>9,40</b>	9,5	8,5	0,25	1
		11,0	10,0	0,50	
		13,0	11,5	1,00	

PP  
Polypropylene  
BPA free



**Jarras medidoras Pro**  
Pot mesureur · Mass Behälter  
Measuring jugs · Jarras de medidas

Ref	€	Ø (cm)	h(cm)	L	U.Venta
67210	<b>3,60</b>	9,0	13,8	0,5	1
67211	<b>4,70</b>	12,0	17,0	1,0	1
67212	<b>8,10</b>	15,0	20,8	2,0	1
67213	<b>10,60</b>	17,0	23,5	3,0	1
67214	<b>16,40</b>	20,0	27,5	5,0	1

PP  
Polypropylene  
BPA free



**Set 5 jarras medidoras Pro**  
Setn 5 pichets doseurs · Messbecher, 5 Er-Set  
Set of 5 measuring jugs · Conjunto 5 jarras medidas

Ref	€	cm	h(cm)	L	U.Venta
67215	<b>41,00</b>	15x9	15,3	0,5	1
		18x11	18,8	1,0	
		22x15	23,0	2,0	
		24x17	26,0	3,0	
		27x20	30,2	5,0	

# Cazos y cucharas de medición

INOX 18/10  
Dishwasher



**Graduadas y marcadas en ml y tsp**  
Marked and graduated in ml and cups

**Juego de cucharas medidoras**  
Ensemble de cuillères à doser · Messlöffel-Set  
Measuring set · Jogo de colheres de medidas

Ref	€	ml	U.Venta
A 67001	<b>11,00</b>	0,62/1,25/2/5/15	1
B 67037	<b>4,10</b>	1,25/2,5/5/15	1

**Muestra los resultados en gramos (g) y onzas (oz)**  
Shows the results in grams (g) and ounces (oz)



**Cuchara medidora digital**  
Cuillère avec Balance Digital · Digitale Löffelwaage  
Digital spoon scale · Colher de pesar Digital

Ref	€	Peso (g)	División (g)	Largo (cm)	U.Venta
62519	<b>40,60</b>	300	0,10	28	1

INOX 18/10



**Librador Inox**  
Pelle à farine · Mehlschaufel  
Ice shovel · Corredor

Ref	€	ml	Largo (cm)	Ancho (cm)	U.Venta
67012	<b>17,90</b>	60	19,0	5,0	6
67013	<b>20,80</b>	110	21,5	6,0	6
67014	<b>24,60</b>	200	24,0	7,0	6
67016	<b>27,30</b>	260	25,5	8,5	1
67017	<b>30,30</b>	360	29,0	10,0	6
67018	<b>32,70</b>	470	31,0	11,0	6
67019	<b>40,70</b>	640	35,0	12,5	6
67020	<b>48,70</b>	860	38,0	14,0	6

**Graduadas y marcadas en ml y tsp**  
Marked and graduated in ml and cups



**Juego de cazos medidores**  
Ensemble de dosettes à doser · Mass-Pfännchen-Set  
Measuring cup · Jogo de caçaroles de medidas

Ref	€	ml	U.Venta
A 67007	<b>11,90</b>	60/80/125/250	4
B 67036	<b>6,30</b>	60/80/120/180/235	1

- **Cuchara báscula con pantalla digital y selección de medidas entre gramos u onzas.**
- **Ideal para pesar pequeñas cantidades: levadura, especias, suero, aceite, etc.**
- **Diseñado para recetas de poco gramaje y alta precisión.**
- **Apagado automático. Función congelación de pantalla. Función tara.**
- **Cuchara desmontable; se puede lavar en el lavavajillas.**
- **Medidas: Largo total con mango: 22 x 2,5 cm / Cuchara: 6 x 4,5 x 2 cm**
- **Pila incluida.**
- **Para una óptima medición se aconseja posicionar la cuchara sobre una superficie.**

- Spoon scales with digital screen and selection of measures between grams or ounces.
- Ideal to weigh small amounts: yeast, spices, serum, oil, etc.
- Designed for little weight and high precision recipes.
- Auto power off. Screen freezing function. Tara function
- Detachable spoon; You can wash it in the dishwasher.
- Measures: Total length with handle: 22 x 2.5 cm / spoon: 6 x 4.5 x 2 cm
- Pila included.
- For optimal measurement it is advisable to position the spoon on a surface.

PC  
Polycarbonate



**Librador**  
Pelle à farine · Mehlschaufel  
Ice shovel · Corredor

Ref	€	ml	Mango (cm)	U.Venta
A 67021	<b>5,90</b>	170	12	1
B 67022	<b>11,90</b>	900	12	1
C 67023	<b>16,30</b>	1800	14	1



# Boles



- Set de 3 boles de acero inoxidable de máxima calidad.
- Acabado interior y exterior satinado.
- Versátiles: ideales para mezclar, batir, preparar masas y servir ensaladas o salsas.
- Perfectos para almacenar y conservar los alimentos.
- Compuesto por 3 boles perfectamente apilables entre sí.
- Base 100% antideslizante.
- Incluye 3 tapas herméticas fabricadas en polipropileno, libres de BPA.
- Marcaje de capacidad en el interior (L).
- Fácil limpieza.

- Ensemble de 3 bols en acier inoxydable de qualité maximale.
- Finition intérieure et extérieure satinée.
- Polyvyle: idéal pour mélanger, battre, préparer des masses et servir les salades ou les sauces.
- Parfait pour stocker et conserver la nourriture.
- Composé de 3 bols parfaitement empilables les uns avec les autres.
- Base 100% non glissante.
- Comprend 3 couvertures hermétiques en polypropylène, sans BPA.
- Marquage de capacité à l'intérieur (L).
- Nettoyage facile.

- Set of 3 maximum quality stainless steel bowls.
- Satinated interior and exterior finish.
- Versatile: Ideal to mix, beat, prepare masses and serve salads or sauces.
- Perfect to store and conserve food.
- Composed of 3 perfectly stackable bowls with each other.
- 100% non-slip base.
- Includes 3 hermetic covers made of polypropylene, BPA free.
- Capacity marking inside (L).
- Easy cleaning.



garinox®



## Set 3 boles Inox

Ensemble de 3 récipients · Schüsseln, 3er-Set  
Set of 3 bowls · Conjunto de 3 tigelas

Ref	€	Ø (cm)	h(cm)	L	U.Venta
60050	33,30	16	10,0	1,5	1
		18	11,0	2,2	
		20	12,5	3,0	
60051	44,90	20	12,5	3,0	1
		22	13,5	3,8	
		24	14,0	4,0	

## Bol Cónico Garinox

Bol conique · Schüssel, konisch  
Conical mixing bowl · Bacia cónica

Ref	€	Ø (cm)	h(cm)	L	U.Venta
14016	3,90	16	6,5	0,90	12
14019	5,30	20	7,5	1,40	12
14025	9,70	24	9,0	2,50	1
14029	13,20	30	11,0	4,30	1
14033	18,30	34	13,5	7,50	1
14040	23,30	40	15,5	11,50	1
14046	33,10	45	17,5	17,40	1
14049	38,80	50	19,0	22,60	1



## Set 3 boles Multi

Ensemble de 6 récipients · Schüsseln, 6er-Set  
Set of 6 bowls · Conjunto de 6 tigelas

Ref	€	Ø (cm)	h(cm)	L	U.Venta
60055	20,50	10,0	5,0	0,25	1
		14,0	6,8	0,80	
		17,0	8,0	1,15	
		20,3	9,5	2,00	
		24,3	11,0	3,35	
		28,3	12,5	5,25	

Jarra medidora · Measuring jug (0,5 L)



Jarra medidora · Measuring jug (1,0 L)



Escurreidor · Colander (2,0 L)



Bol mezclador · Mixing bowl (3,5 L)



## Set de 4 boles Practic

Ensemble de 4 récipients · Schüsseln, 4er-Set  
Set of 4 bowls · Conjunto de 4 tigelas

Ref	€	Ø (cm)	h(cm)	L	U.Venta
62633	36,10	11,5	9,3	0,5	1
		14,5	10,6	1,0	
		18,5	13,0	2,0	
		22,0	15,0	3,5	



Raspador · Scraper

6 cazos medidores  
6 measuring cups  
(7,5 ml, 15 ml, 60 ml,  
85 ml, 125 ml, 250 ml)

Embudo · Funnel

Jarra medidora  
Measuring jug  
(1,0 L / 4 cups)



## Set de medición Exact

Set de mesure · Messbecher-Set  
Measuring set · Conjunto de medição

Ref	€	cm	h(cm)	U.Venta
62740	16,40	20x11	13,6	1



- Set de 6 boles de polipropileno de máxima calidad, 100% libres de BPA.
- Versátiles: ideales para mezclar, batir, preparar masas, servir ensaladas o salsas.
- Compuesto por 6 boles perfectamente apilables entre sí.
- Incluye 6 tapas fabricadas en polipropileno, libres de BPA.
- Perfectos para almacenar y conservar los alimentos.
- Fácil limpieza. Cuerpos aptos para el lavavajillas.

- Set of 6 polypropylene bowls of maximum quality, 100% free of BPA.
- Versatile: Ideal to mix, beat, prepare masses, serve salads or sauces.
- Composed of 6 bolts perfectly stackable to each other.
- Includes 6 covers manufactured in polypropylene, BPA free.
- Perfect to store and conserve food.
- Easy cleaning. Bodies suitable for dishwasher.

- Práctico y versátil.
- Fabricados en polipropileno de máxima calidad. 100% Libre de BPA.
- Jarras medidoras graduadas (mililitros/cups).
- Pequeño vertedor lateral para facilitar el vertido.
- Asas ergonómicas para facilitar el transporte.
- 100% estable gracias a los pies antideslizantes.
- Apilables; ocupan el mínimo espacio posible.
- Aptos para el lavavajillas.

- Practical and versatile.
- Manufactured in maximum quality polypropylene. 100% BPA free.
- Graduated meter jugs (milliliters/cups).
- Small lateral dump to facilitate discharge.
- Ergonomic handles to facilitate transportation.
- 100% stable thanks to non-slip feet.
- Stackable; They occupy the minimum possible space.
- Apt for the dishwasher.

- Todas las piezas fabricadas en materiales de máxima calidad, libres de BPA.
- Versátil. Ideal para ingredientes líquidos y secos.
- Jarra con sistema de lectura rápida en litros y cups. Permite comprobar el nivel del líquido mientras se está vertiendo el contenido.
- Cazos marcados en ml y bps para una rápida identificación.

- All pieces made of maximum quality materials, BPA free.
- Versatile. Ideal for liquid and dry ingredients.
- Jug with fast reading system in liters and cups. It allows to check the level of the liquid while the content is pouring.
- Saves marked in ML and BPS for rapid identification.

# Calderos

INOX  
18/10



- Ideal para mezclar los alimentos.
- Para uso profesional o doméstico.
- Fabricado en acero inoxidable 18/10, material muy resistente a la corrosión y ácidos alimentarios.
- Fácil limpieza: apto para el lavavajillas.

- Idéal pour mélanger les aliments.
- Pour un usage professionnel ou domestique.
- Fabriqué en acier inoxydable 18/10, très résistant à la corrosion et aux acides alimentaires.
- Nettoyage facile: adapté au lave-vaisselle.

- Ideal for mixing food.
- For professional or domestic use.
- Manufactured in stainless steel 18/10, very resistant to corrosion and food acids.
- Easy cleaning: suitable for dishwasher.



## Caldero semiesférico sin asas

Bassine hemispherique s/anses · Schneeschlagkessel ohne Griffe  
Semi-spherical mixing bowl wout/handles · Bacia semi-esférica sem asas

Ref	€	Ø (cm)	h(cm)	L	U.Venta
50323S	37,50	22	11,0	2,70	1
50327S	43,80	26	13,0	4,00	1
50333S	58,80	32	17,0	9,50	1
50337S	66,70	36	18,0	12,00	1
50341S	111,90	40	21,0	14,50	1
50300	26,40	-	-	-	1

## Caldero semiesférico con asas

Bassine hemispherique a/anses · Schneeschlagkessel mit Griffe  
Semi-spherical mixing bowl w/handles · Bacia semi-esférica com asas

Ref	€	Ø (cm)	h(cm)	L	U.Venta
50323	49,40	22	11,0	2,70	1
50327	56,20	26	13,0	4,00	1
50333	72,20	32	17,0	9,50	1
50337	77,70	36	18,0	12,00	1
50341	111,10	40	21,0	14,50	1
50300	26,40	-	-	-	1



## Caldero cónico

Bassine conique · Wanne  
Mixing bowl · Bacia cónica

Ref	€	Ø (cm)	h(cm)	L	U.Venta
60013	12,70	13	6,1	0,55	1
60016	13,80	16	9,1	1,00	1
60020	18,90	20	11,7	2,12	1
60024	22,70	24	12,6	3,50	1
60028	28,40	28	13,4	5,25	1
60032	31,90	32	15,0	7,65	1
60036	44,10	36	16,0	11,00	1
60040	51,20	40	18,0	15,00	1

## Caldero cónico con asas

Bassine conique à anses · Wanne mit Griffe  
Conical mixing bowl · Bacia cónica con asas

Ref	€	Ø (cm)	h(cm)	L	U.Venta
50828	44,30	28	13,2	5,00	1
50832	49,10	32	14,5	7,00	1
50836	56,20	36	16,0	11,00	1
50840	62,50	40	18,0	15,00	1
50845	74,60	45	20,0	22,00	1
50850	89,50	50	21,0	30,00	1

# Cedazos

INOX  
18/10



Cedazo  
Tamis · Mehlsieb  
Sieve · Peneira

Ref	€	Ø (cm)	Hilos por pulgada Wires-inch
68058	39,50	18	50
68050	43,20	20	
68057	60,00	26	
68053	72,30	30	
68054	98,70	40	
68350	39,80	20	35
68357	59,90	26	
68351	67,80	30	
68354	101,40	40	
68250	39,50	20	25
68252	59,50	26	
68253	66,20	30	
68254	102,40	40	
68026	62,30	26	20
68023	69,30	30	
68024	104,60	40	

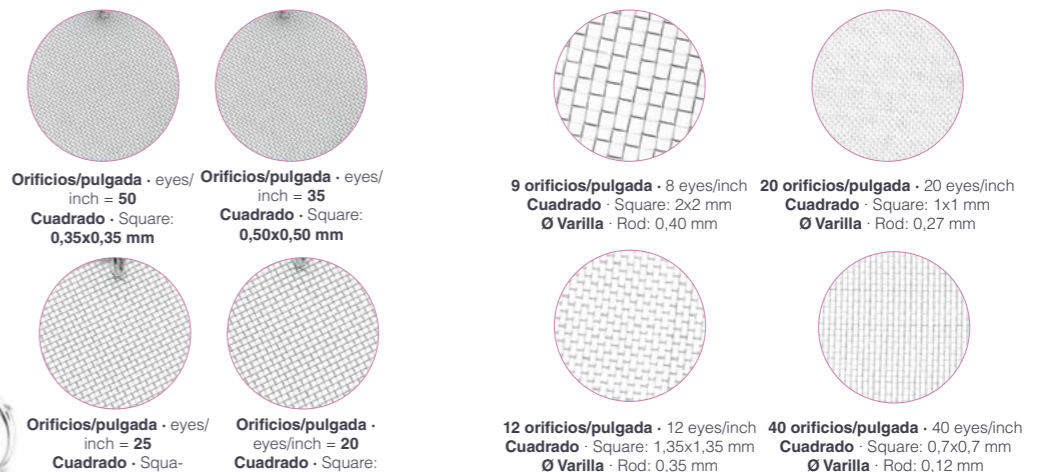

## Cedazo 4 mallas intercambiable

Tamis à 4 mailles interchangeables · 4 Austauschbare Masche-Sieb  
Mesh sieve interchangeable · Peneira de 4 malha intercambiáveis

Ref	€	Ø (cm)	U.Venta
68340	33,90	20	1
68341	40,90	23	1
68342	50,70	25	1

Ideal para harina, chocolate en polvo, levaduras, etc. Mecanismo en el asa en forma de gatillo  
Ideal for flour, chocolate powder, yeasts, etc. Trigger handle mechanism



INOX

## Cribador de harina Inox

Tamis · Mehlsieb  
Flour sifter · Crivador de farinha

Ref	€	Ø (cm)	Peso (Kg)	U.Venta
67011	10,90	10,0	0,35	5
67015	14,50	12,0	0,50	1



AS  
Plastic



## Cribador de harina

Tamis · Mehlsieb  
Flour sifter · Crivador de farinha

Ref	€	Ø (cm)	Peso (Kg)	U.Venta
67025	7,40	10	0,35	6

# Rasquetas

INOX  
Dishwasher

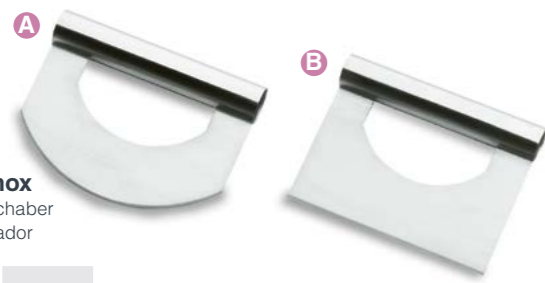

INOX  
18/10

**Rasqueta Inox Black**  
Coupe pate · Schaber  
Scraper · Raspador

Ref	€	cm	U.Venta
67029	9,70	16,5x10,5	6

**Rasqueta Inox**  
Coupe pate · Schaber  
Scraper · Raspador

Ref	€	cm	U.Venta
67005	13,20	15x9	6
67006	12,70	15x9	6



Diseño apilable  
Stackable design

SI 230°C  
Silicone Max BPA free

**Rasqueta Flex**  
Coupe pate · Schaber  
Scraper · Raspador

Ref	€	cm	U.Venta
67414	9,10	9x15	1

**Rasqueta**  
Coupe pate · Schaber  
Scraper · Raspador

Ref	€	cm	U.Venta
67041	25,80	13,8x13	1

# Decoración

PP  
Polypropylene Dishwasher BPA free



**Rasqueta decoración**  
Grattoir à pate · Teigschaber  
Dough scrape · Raspador de masa

Ref	€	mm	U.Venta
68132	1,80	155x105	24



**Peine decoración**  
Peigne du decoration · Verzierungskamm  
Decorating comb · Pente de decoração

Ref	€	mm	U.Venta
68136	1,50	110	24



**Juego peines decoración**  
Set peigne du decoration · Verzierungskamm-Set  
Decorating comb set · Jogo pente de decoração

Ref	€	Piezas	U.Venta
68137	6,00	7	1

ABS  
Plastic

**Estacas decoración Fondant**  
Outils de modelisation · Modellierset  
Modeling tools · Ferramentas demodelagen



Ref	€	Piezas	U.Venta
68090	11,50	12	1

# Pinceles

SI INOX 230°C  
Silicone 18/10 Max Dishwasher BPA free

- Para cocina o repostería.
- Pinceles ideales para pincelar con aceites o salsas, marinar carnes o pescados, engrasar moldes, untar con aceite, huevo batido, almíbar, etc.
- No absorben olores ni sabores.

- Pour la cuisine ou la pâtisserie.
- Pinceaux parfaits pour badigeonner de l'huile ou des sauces, mariner des viandes ou des poissons, graisser des moules, étaler de l'huile, de l'œuf battu, du sirop, etc.
- N'absorbent ni les odeurs ni les goûts.

- For cooking or baking.
- Brushes ideal for brushing oils or sauces, marinating meat or fish, greasing baking tins, and basting with oil, egg, syrup, etc.
- Doesn't absorb smells or tastes.

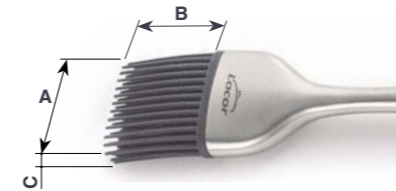

PP  
Polypropylene

**Pincel Virola**  
Pinceau · Silikonpinsel  
Brush · Pincel

Ref	€	A (cm)	B (cm)	Largo (cm)	U.Venta
64430	4,40	2,8	5,0	23,0	1
64435	5,10	3,2	5,5	24,0	1
64440	5,30	3,8	5,5	24,5	1
65044	6,60	4,2	6,5	25,0	1
65050	7,90	4,7	6,5	26,0	1

Dimensiones reales · Real dimensions

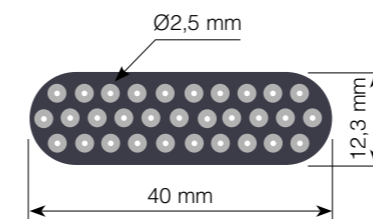

SI INOX  
Silicone 18/10

**Pincel de silicona Mix**  
Pinceau de cuisine en silicone · Silikonpinsel  
Silicone brush · Pincel de silicone

Ref	€	A (cm)	B (cm)	Largo (cm)	U.Venta
64431	7,40	3,8	4,0	24	12



**Pincel de silicona Pro**  
Pinceau en silicone · Silikonpinsel  
Silicon brush · Pincel silicone

Ref	€	A (cm)	B (cm)	Largo (cm)	U.Venta
64418	11,10	4,0	4,0	22	1
64422	12,40	4,0	4,0	23	1



**Pincel de silicona**  
Pinceau en silicone · Silikonpinsel  
Silicon brush · Pincel de silicone

Ref	€	A (cm)	B (cm)	Largo (cm)	U.Venta
64441	6,90	5,8	3,4	23	1



HAYA 230°C  
Wood Max LFGB Food Grade Silicone

**Pincel de silicona Unite**  
Pinceau · Silikonpinsel  
Brush · Pincel

Ref	€	A (cm)	B (cm)	Largo (cm)	U.Venta
68196	4,20	5,5	3,1	24,5	1



# Espátula para atemperar

INOX  
Dishwasher



- Espátula profesional de acero inoxidable de máxima calidad, de grado alimenticio, resistente y duradero.
- Diseñado para templar chocolate recién fundido, glasear pasteles, cortar masas de galletas, pizzas, etc.
- Hoja superafilada trapezoidal semiflexible de 16/22 cm de ancho.
- Mango ergonómico y resistente con orificio colgante.

- Spatule professionnelle en acier inoxydable de la plus grande qualité, à usage alimentaire, résistante et durable.
- Conçue pour le tempérage du chocolat fraîchement fondu, le glaçage des gâteaux, couper des pâtes à biscuits, pour les pizzas, etc.
- Feuille très aiguisée semi-flexible de 16/22 cm de largeur.
- Manche ergonomique et résistant, avec œillet de suspension.

- Professional spatula made of high quality, food-grade stainless steel, strong and durable.
- Designed for tempering freshly melted chocolate, glazing cakes, cutting dough for biscuits, pizzas, etc.
- Super-sharp, semi-flexible 16/22 cm wide trapezoidal blade.
- Sturdy, ergonomic handle with hanging hole.

## Espátula para atemperar chocolate

Spatule pour tempérer le chocolat · Spatel zum Temperieren von Schokolade  
Chocolate tempering spatula · Espátula para atemperar chocolate

	Ref	€	Largo (cm)	U.Venta
A	60533	7,00	16	1
B	60534	7,60	22	1

# Espátulas de silicona

SI FE LFGB 230°C  
Silicone Iron Food Grade Silicone Max  
Dishwasher BPA free

- Fabricados en silicona de alta calidad libre de BPA.
- Núcleo reforzado para una mayor resistencia sin perder flexibilidad en los bordes. Diseñados en una sola pieza, sin costuras ni grietas.
- Resistentes a altas temperaturas.
- Mango ergonómico suave al tacto y antideslizante.
- No rayan ni dañan artículos de cocina con antiadherente.
- Fáciles de limpiar. Aptas para el lavavajillas.

- Fabriqué en silicone de haute qualité sans BPA.
- Noyau renforcé pour une résistance accrue sans perte de flexibilité des bords. Conception monobloc, sans coutures ni fissures.
- Résistant aux hautes températures.
- Poignée ergonomique, douce au toucher et antidérapante.
- Ne raye pas et n'endommage pas les ustensiles decuisine antiadhésifs.
- Facile à nettoyer. Lavable au lave-vaisselle.

- Made of high quality BPA free silicone.
- Reinforced core improves strength without losing flexibility around the edges. Designed in a single piece without seams or cracks.
- Can withstand high temperatures.
- Soft and non-slip ergonomic handle.
- Does not scratch cooking utensils with non-stick coating.
- Easy to clean. Dishwasher safe.

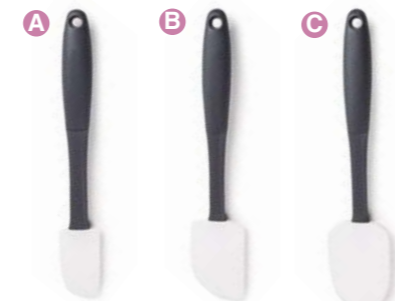
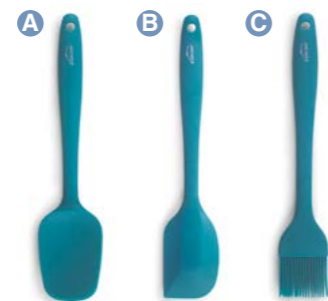

## Utensilios Grey

Utensiles en silicone · Silikonutensilien  
Silicone utensils · Utensílios de silicone

	Ref	€	Largo (cm)	U.Venta
A	64463	5,60	27,5	1
B	64464	5,60	27,5	1
C	64465	5,70	27,5	1

## Utensilios Ocean

Utensiles en silicone · Silikonutensilien  
Silicone utensils · Utensílios de silicone

	Ref	€	Largo (cm)	U.Venta
Set	64452	17,20	27,5	1
A	64453	6,00	27,5	1
B	64454	6,00	27,5	1
C	64455	6,00	27,5	1

## Espátula Comfort

Spatule en silicone · Teigschaber  
Silicone spatula · Espátula de silicone

	Ref	€	Largo (cm)	U.Venta
A	64444	6,10	28	1
B	64445	6,80	30	1
C	64446	6,90	31	1

## Espátula White

Spatule en silicone · Teigschaber  
Silicone spatula · Espátula de silicone

	Ref	€	Largo (cm)	U.Venta
	67421	4,70	20	1
	67427	7,00	26	1
	67433	15,30	32	1



## Espátula Grey

Spatule en silicone · Teigschaber  
Silicone spatula · Espátula de silicone

	Ref	€	Largo (cm)	U.Venta
	67434	4,80	30	12
	67435	5,60	29	12



## Espátula silicona

Spatule en silicone · Teigschaber  
Silicone spatula · Espátula de silicone

	Ref	€	Largo (cm)	U.Venta
A	64450	5,70	25	6
	64451	9,10	35	6
B	64460	6,00	25	6
	64461	10,00	35	6

## Espátula para tarros

Spatule en silicone · Teigschaber  
Silicone spatula · Espátula de silicone

	Ref	€	cm	Largo (cm)	U.Venta
	64490	2,50	3,8x8,4	25	1
	64491	4,10	4,8x10,8	35	1



- Espátula extraplana fabricada en nylon y fibra de vidrio especialmente diseñada para uso profesional.
- Sólida e indeformable. Resistente a altas temperaturas.
- No absorbe olores ni sabores.
- Apta para el lavavajillas.

- Spatule extra plate fabriquée en nylon et fibre de verre spécialement conçue pour un usage professionnel.
- Résistante aux hautes températures.
- Solide et indéformable. N'absorbe ni les odeurs ni les goûts.
- Apte pour le lave-vaisselle.

- Super thin, glass fibre nylon spatula, specially designed for professional use.
- High temperature resistant.
- Robust and non-deformable.
- Does not absorb smells or flavours.
- Dishwasher safe.

## Set repostería- 20 pcs.

Exposant pâtisserie · Aufsteller Pastry  
Pastry display · Expositor pastelaria

	Ref	€	Largo (cm)	Piezas	U.Venta
A	64424	80,40	-	Caja (20 pcs.) · Set (20 pcs.)	1
B	64426	4,10	23,0	Pincel · Brush	12
C	64427	4,10	23,0	Espátula · Spatula	12
D	64428	4,10	23,0	Lengua gato · Spatula	12
E	64429	4,10	23,0	Batidor · Whisk	12

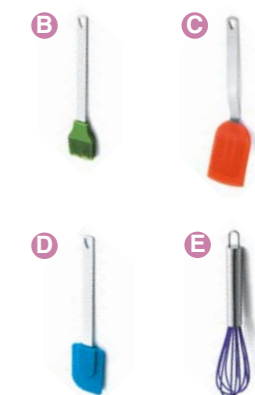



# Batidores

INOX 18/10  
Dishwasher

INOX

## Batidor mini

Mini fouet Inox · Mini-Schneebeesen  
Mini whisk · Mini batedor Inóx

Ref	€	Largo (cm)	U.Venta
61615	5,60	15	12
61620	6,20	20	12



SI 250°C Max  
Silicone BPA free

## Batidor varilla silicona

Fouet en silicone · Ruhrbesen auf Silikon  
Silicone wire whisk · Batedor vareta silicone

Ref	€	Largo (cm)	U.Venta
61621	8,20	20	12
61622	9,10	25	6
61623	10,20	30	12

## Batidor Extra 8

Fouet inox extra 8 · Schneebeesen, Extra 8  
Extra 8 whisk · Batedor Extra 8

Ref	€	Largo (cm)	U.Venta
61625	8,70	25	6
61630	8,90	30	6
61635	9,30	35	6
61640	10,30	40	6
61645	11,10	45	6
61650	12,40	50	6
61655	13,20	55	6
61660	14,20	60	6

## Batidor gigante

Fouet à purée · Kesselbesen  
Big whisk · Batedor gigante

Ref	€	cm	Diámetro varilla (mm)	U.Venta
60610	64,10	100	3	12
60612	82,20	129	3	12

## Batidor Super 12

Fouet inox super 12 · Schneebeesen, super 12  
Super 12 whisk · Batedor Super 12

Ref	€	Largo (cm)	U.Venta
61626	8,00	25	6
61631	8,60	30	6
61636	9,30	35	6
61641	9,90	40	6
61646	10,20	45	6
61651	11,10	50	6



INOX 18/10

SI Silicone

HAYA Wood

LFGB Food Grade Silicone

Dishwasher

BPA free

## Batidor varilla con espátula

Fouet avec grattoir · Schneebeesen mit Schaber  
Whisk with spatula · Batedeira de varas com espátula

Ref	€	Largo (cm)	U.Venta
68199	6,10	27,0	1
61627	6,40	32,0	12



Especial para preparar comidas que no contengan alérgenos.  
Specially for preparing meals that do not contain allergens.

SI 250°C Max  
Silicone BPA free

## Batidor Fibreglass

Fouet · Schneebeesen  
Whisk · Batedores

Ref	€	Largo (cm)	U.Venta
61624	12,10	25	6
61629	14,00	30	6
61634	15,80	35	6
61639	17,50	40	6
61644	21,00	45	6
61649	22,00	50	6

INOX

## Batidor Manivela

Batteur-mélangeur à manivelle · Schneequirl  
Egg beater · Batedor de manivela

Ref	€	U.Venta
62901	19,60	6



- Batidor de varilla con práctico raspador de silicona incorporado.
- 2 en 1 : bate y recoge toda la mezcla del bol de forma fácil y rápida.
- Varillas fabricadas en acero inoxidable.
- Espátula de silicona inyectada en una de las varillas (certificado LFGB y libre de BPA).
- Mixeur en bâton avec raclette en silicone intégrée très pratique.
- 2 en 1 : fouette et recueille tous les mélanges dans le bol rapidement et facilement.
- Lames en acier inoxydable.
- Spatule en silicone injectée dans l'une des lames (certifiée LFGB et sans BPA).

Batidor · Whisk

Espátula · Spatula



## Batidor antialérgico Fibreglass

Fouet · Schneebeesen  
Whisk · Batedores

Ref	€	Largo (cm)	U.Venta
61590	11,10	25	6
61591	12,00	30	6
61592	14,00	35	6

## Batidor silicona Fibreglass

Fouet en silicone · Schneebeesen, Silikon  
Silicone whisk · Batedores silicona

Ref	€	Largo (cm)	U.Venta
61524	11,10	25	6
61529	12,00	30	6
61534	14,00	35	6

## Batidor Capuccino

Batteur pour cappuccino · Capuccino- Mixer  
Capuccino mixer · Batedor capuccino

Ref	€	W	U.Venta
69041	27,40	2,7	1



# Rodillos

INOX  
18/10



- Ideal para extender pequeñas cantidades de masa.
- Acabado uniforme para trabajar pastas, mazapán, fondant, etc.

- Idéal pour étaler de petites quantités de pâte.
- Finition uniforme pour travailler des pâtes, du massepain, des fondants, etc.

- Perfect for spreading small quantities of dough.
- Uniform nish when working with pastries, marzipan, fondant, etc.

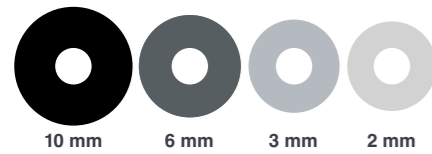
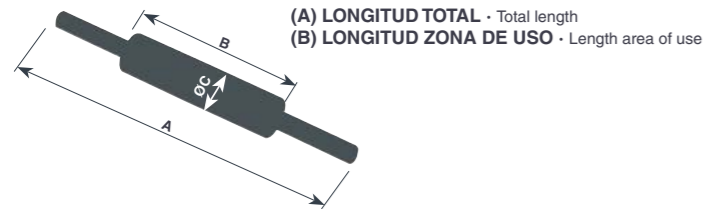

4 discos extraíbles · 4 removable discs



Anillas de polipropileno  
Polypropylene rings

Guía para medir el ancho de la masa  
Guide to measure the width of the dough



## Rodillo amasar con anillas

Rouleau hêtre avec anneau · Teigrolller mit Ringen  
Rolling pin with guide rings · Rolo com anilhas

Ref	€	Anillas	Largo (cm)	U.Venta
A 67142	15,70	10/6/2	38	1
B 67143	16,30	10/6/3/2	38	1



## Rodillo cortador croissant

Rouleau pour coupe croissant · Schneidewalze für Croissantteig  
Croissant dough cutter wheel · Rolo cortador de croissants

Ref	€	Ancho (cm)	B (cm)	Ø (cm)	U.Venta
68161	34,30	40,5	15,3	7,7	1

## Rodillo

Rouleau patisier · Teigrolller  
Rolling pin · Rolo

Ref	€	A (cm)	ØCx B (cm)	U.Venta
67140	43,10	40	Ø5x20	3
A 67148	48,10	48	Ø6,3x25	4
67156	51,40	56	Ø6,3x33	4
B 67149	49,90	48	Ø6,3x25	4
68153	11,30	50	30	1
68154	21,40	60	40	1
D 68142	10,00	43	Ø4,4	1
68150	10,50	50	Ø4,8	1
68141	36,60	43	Ø4,4	1
E 68151	44,70	90	Ø4,8	1

## Rodillo picar pasta

Rouleau pique vite pointe metal · Teig-Gitterschneider  
Roller docker metal · Rolo de picar massas

Ref	€	Largo (cm)	U.Venta
68213	37,40	13	6



## Rodillo Roller

Rouleau patisier · Teigrolller  
Rolling pin · Rolo

Ref	€	cm	Largo (cm)	U.Venta
A 68801	6,30	14	19,5	1
B 68802	6,30	14	19,5	1
C 68803	6,30	14	19,5	1
D 68804	6,30	12	19,5	1

- Cortapastas extensible con 5 ruedas rizadas. Diámetro de la rueda 5,5 cm.
- Fabricada en acero inoxidable de gran calidad.
- Ideal para cortar todo tipo de masas, hojaldres, fondant, etc.
- Cortes precisos y tiras del mismo tamaño, ajustando el ancho de corte mediante un mecanismo de extensión.
- Las ruedas se bloquean en la posición deseada apretando la tuerca de mariposa.

- Roulette découpe-pâte extensible avec 5 roues cannelées. Diamètre des roues : 5,5 cm.
- Fabriqué en acier inoxydable de haute qualité.
- Idéal pour couper tous les types de pâte, pâte feuilletée, brisée, etc.
- Coupes précises et bandes de même taille, en réglant la largeur de coupe au moyen d'un mécanisme d'extension.
- Les roues sont bloquées dans la position souhaitée en serrant les écrous à ailettes.

- Extendable cutter with 5 crimped wheels. Wheel diameter: 5.5 cm.
- Made of high quality stainless steel.
- Ideal for cutting all types of dough, puff pastry, fondant, etc.
- Gives precise cuts and strips of the same size by adjusting the extending mechanism to set the desired cutting width.
- The wheels lock into the desired position by tightening the wing nuts.



Cerrado · Closed: 5,5x24 cm  
Abierto · Open: 49,5x24 cm  
Cuchillas · Blades: Ø5,5 cm



## Cortapastas extensible

Rouleau multicouper · Teigschneider  
Dough divider expandable · Corta-massas extensível

Ref	€	Largo (cm)	U.Venta
68246	20,00	24	1

- 68801: Corta con rapidez y precisión tiras de masa lisas y uniformes. Gracias a sus 9 ruedas extraíbles, podrás ajustar la anchura deseada.
- 68802: Diseñado para perforar cualquier tipo de masa (pasteles, quiches, hojaldres, pizza, etc.) Evita la formación de burbujas en las bases de masa durante el horneado.
- 68803: Corta con rapidez y precisión tiras de masa onduladas y uniformes. Gracias a sus 9 ruedas extraíbles, podrás ajustar la anchura deseada.
- 68804: Diseñado para formar una rejilla uniforme de pasta. Efecto simétrico enrejado, ideal para empanadas, pasteles de manzana, hojaldres, etc.
- Mango ergonómico
- Diseñado para todo tipo de masas. Deja volar tu imaginación.
- Fácil limpieza, 100% desmontable y apto para el lavavajillas.
- Material: ABS y mango de polipropileno. Libre de BPA.

- 68801 : Coupez avec rapidité et précision des bandes de pâte lisses et uniformes. Grâce à ses 9 roulettes amovibles, vous pourrez régler la largeur souhaitée.
- 68802 : Conçu pour piquer tout type de pâte (tartes, quiches, feuilletés, pizza, etc.). Évite la formation de bulles sur la base des pâtes pendant la cuisson.
- 68803 : Coupez avec rapidité et précision des bandes de pâtes ondulées et uniformes. Grâce à ses 9 roulettes amovibles, vous pourrez régler la largeur souhaitée.
- 68804 : Conçu pour faire un dessus de treillis de pâte uniforme. Effet symétrique de losanges, idéal pour des empanadas, des tartes aux pommes, des feuilletés, etc. Conçu pour tout type de pâtes. Laissez libre cours à votre imagination.
- Manche ergonomique.
- Nettoyage facile, 100% démontable et apte pour le lave-vaisselle.
- Matériau : ABS et manche en polypropylène. Sans BPA.

- 68801 : Quickly and accurately cuts smooth, even strips of dough. 9 removable cutting wheels allow you to adjust the desired width.
- 68802 : Designed for poking holes (also referred to as 'docking') in any type of dough (cakes, quiches, puff pastry, pizza, etc.). Prevents formation of air bubbles in dough bases during baking.
- 68803 : Quickly and accurately cuts uniform strips of dough into waves. 9 removable cutting wheels allow you to adjust the desired width
- 68804 : Designed for creating a uniform lattice pattern. Symmetrical lattice effect, ideal for pastries, apple pies, puff pastry, etc. Designed for all types of dough. Let your imagination run wild!
- Ergonomic handle.
- Easy to clean, fully detachable and dishwasher safe.
- Material: ABS with polypropylene handle. BPA free



## Cortapastas extensible rizado

Rouleau multicouper · Teigschneider  
Dough divider expandable · Corta-massas extensível

Ref	€	Largo (cm)	U.Venta
68247	20,00	49,5	1

# Cortadores

INOX  
Dishwasher



- Fabricados en acero inoxidable 18/10 de gran calidad.
- Ideales para repostería (pasteles, muffins, galletas, fondant, pan, gelatina, pancake, etc.).
- Aseguran un corte 100% preciso y seguro.
- Versátiles: se pueden usar como moldes para hojaldres o decoración de platos.
- Aptos para el lavavajillas.

- Made of high-quality 18/10 stainless steel.
- Ideal for baking (cakes, muffins, biscuits, fondant, bread, jelly, pancake, etc.).
- They ensure 100% accurate and safe cutting.
- Versatile: can be used as moulds for puff pastry or plate decoration.
- Dishwasher safe.

Medidas · Sizes (cm): Ø2 / Ø3 / Ø4 / Ø5 / Ø6 / Ø7 / Ø8 / Ø9 / Ø10

## Caja de 9 cortapastas redondos

Boîte de 9 découpoirs ronds unis · 9 Tlg. Teigausstecher, rund, glatt  
Set of 9 round dough cutters · Caixa de 9 corta-massas ovais redondos

Ref	€	Ø (cm)	U.Venta	
68069	28,50	4,2	1	Liso · Pain
68070	30,90	4,2	1	Rizado · Fluted
68091	25,80	3,5	1	Liso · Pain
68092	25,80	3,5	1	Rizado · Fluted



SI  
Silicone

LFGB  
Food Grade  
Silicone

Dishwasher

BPA free



- Conjunto de 5 originales sellos de silicona intercambiables.
- Mango de madera para un perfecto agarre.
- Silicona de máxima calidad. Libre de BPA.
- Garantiza la completa seguridad alimentaria del producto.

- Set de 5 tampons en silicone originaux interchangeables.
- Manche en bois pour une prise en main parfaite.
- Silicone de la plus grande qualité. Sans BPA.
- Garantit une sécurité alimentaire totale du produit.

- Set of 5 original interchangeable silicon stamp.
- Wood handle for perfect grip.
- Top quality silicone. BPA free.
- Guarantees complete food safety of the end product.

### El set incluye:

- \* Aro ajustable con 6 ranuras que actúan de guía para cortar uniformemente tartas entre Ø 24-30 cm.
- \* Cuchillo de hoja dentada diseñado para laminar fácilmente.
- \* Pala para coger y servir de forma segura.

### The set includes:

- \* Adjustable ring with 6 grooves that work as guides for cutting cakes between Ø 24-30 cm.
- \* Serrated knife designed to cut layers easily.
- \* Spatula for picking up and serving the cake safely.



## Set cortatartas

Jeu de découpeurs de gâteaux · Tortenausstecher-Set  
Cake cutter set · Conjunto de cortador de bolos

Ref	€	Ø (cm)	Ranuras	U.Venta
68527	14,30	24 - 30	6	1



# Aerógrafo

INOX CE

- Ideal para la decoración de tartas, galletas, cupcakes, bombones, etc.
- Permite obtener detalles únicos en creaciones artísticas de repostería.
- El kit contiene: compresor, aerógrafo y tubo conector.
- Compresor con regulador de presión de aire. 0-2 bares y con un caudal de 0-10 L/min.
- Aerógrafo por gravedad de doble acción con aguja de salida de 0,3 mm.
- Depósito de pintura metálico con capacidad de 7 ml.
- Incluye una caja acolchada para almacenar el aerógrafo.

- Idéal pour la décoration des gâteaux, des biscuits, des cupcakes, des chocolats, etc.
- Il vous permet d'obtenir des détails uniques dans les créations de pâtisseries artistiques.
- Le kit contient: compresseur, tube de compresseur, aérographe et connecteur.
- Compresseur avec régulateur de pression d'air. 0-2 bares et avec un débit de 0-10 L / min.
- Aérographe à double action avec aiguille de sortie de 0,3 mm.
- Dépôt de peinture métallique avec une capacité de 7 ml.
- Comprend une boîte rembourrée pour stocker l'aérographe.

- Ideal for the decoration of cakes, cookies, cupcakes, chocolates, etc.
- It allows you to obtain unique details in artistic pastry creations.
- The kit contains: compressor, airbrush and connector tube.
- Compressor with air pressure regulator.
- 0-2 bars and with a flow of 0-10 l/min.
- Double -action gravity airbrush with 0.3 mm output Wneedle.
- Metallic paint deposit with 7 ml capacity.
- Includes a padded box to store the airbrush.



## Aerógrafo con compresor

Aérographe avec compresseur · Airbrush Spritzpistole mit Kompressor  
Airbrush with compressor · Aerógrafo com compressor

Ref	€	W	Presión	Caudal	Capacidad	U.Venta
69450	103,20	20	0 - 2 bar	0 - 10 L/min	7ml	1

# Sopletes repostería

INOX  
18/10



- Autoencendido por piezoeléctrico.
- Control ajustable de llama.
- Llama antiretorno.
- Sistema seguro de bloqueo.
- Fácil rellenado de gas butano.

- Auto-childing par piézoélectrique.
- Contrôle de flamme réglable.
- Antiretorno appel.
- Système de blocage sûr.
- Easy Farged avec du gaz butane.

- Self -childing by piezoelectric.
- Adjustable flame control.
- Antiretorno call.
- Safe blockage system.
- Easy stuffed with butane gas.



Válvula recarga gas  
Refill valve



## Pistola gas repostería

Torche à caraméliser · Gasbrenner  
Pastry gas torch · Queimadora a gás para pastelaria

Ref	€	Capacidad	h(cm)	U.Venta	
<b>A</b> 68981	<b>19,10</b>	5-6 ml	12,50	1	Micro
<b>B</b> 68982	<b>31,00</b>	19 ml	17,00	1	Mini
<b>C</b> 68983	<b>42,20</b>	65 ml	18,00	1	Chef
<b>D</b> 68988	<b>53,70</b>	40 ml	16,00	1	Profesional
<b>E</b> 68969	<b>22,30</b>	21 ml	13,00	1	Burn

Quando el orificio de entrada de oxigeno este descubierta, la llama será más intensa  
When the oxygen inlet is uncovered, the flame will be more intense



- Soplete para uso doméstico y profesional.
- Diseño elegante, con cuerpo cilindro de gas butano y acabado metalizado.
- Doble llama para una mayor potencia.
- Botón de encendido automático por piezoeléctrico.
- Intensidad de llama ajustable con sistema de llama antirretorno.
- Ergonómico y de fácil agarre. Práctico, seguro y muy fácil de usar.
- Sistema de bloqueo de seguridad.
- Diseñado para caramelizar el azúcar de las cremas, gratinar, tostas, etc.
- Se suministra sin gas.

- Cabezal soplete profesional a gas butano.
- Encendido instantáneo automático por piezoeléctrico.
- Sistema 360°; permite el uso en cualquier posición y siempre con llama constante.
- Llama ajustable; elige tanto el tamaño como la intensidad.
- Diseño ergonómico y de fácil agarre. Práctico, seguro y muy fácil de usar.
- Preparado para caramelizar el azúcar de las cremas, gratinar, tostas, etc.
- Sistema de bloqueo de seguridad.
- Compatible con todos los recambios de gas butano universales.
- El soplete se ajusta fácilmente y con total seguridad al cartucho de gas.



- Torch for domestic and professional use.
- Elegant design, with butane gas cylinder body and metallic finish.
- Double flame for more power.
- Automatic ignition button by piezoelectric ignition.
- Adjustable flame intensity with non-return flame system.
- Ergonomic and easy to grip. Practical, safe and very easy to use.
- Safety locking system.
- Designed for caramelising the sugar in creams, gratins, toasts, etc.
- Supplied without gas.

- Professional butane gas torch head.
- Automatic instantaneous ignition by piezoelectric ignition.
- 360° system; allows use in any position and always with a constant flame.
- Adjustable flame; choose both size and intensity.
- Ergonomic design and easy grip. Practical, safe and very easy to use.
- Prepared for caramelising the sugar in creams, gratins, toasts, etc.
- Safety locking system.
- Compatible with all universal butane gas refills.
- The torch fits easily and securely to the gas cartridge.



## Soplete de gas Master

Torche à caraméliser · Brullierbrennen  
Blow torch · Queimadora a gás

Ref	€	Capacidad	U.Venta
68898	<b>22,40</b>	18,5 ml	1



## Cabezal soplete gas Forza

Torche à caraméliser · Gasbrenner-Aufsatz  
Blow torch head · Queimadora a gás

Ref	€	W	Consumo (g/h)	U.Venta
68899	<b>14,40</b>	1,5 Kw	105	1



- Para poder utilizar distintos tipos de botellas de gas.
- Pour utiliser différents types de bouteilles de gaz.
- To use different types of gas bottles.



## Cabezal soplete gas + adaptador Profesional

Torche à caraméliser + adaptateur · Gasbrenner-Aufsatz + Adapter  
Blow torch head + adapter · Queimadora a gás + adaptador

Ref	€	W	Consumo (g/h)	U.Venta
68974	<b>25,40</b>	1,65	120	1



## Cabezal gas Profesional

Torche à caraméliser · Brullierbrennen  
Blow torch · Queimador a gás

Ref	€	W	Consumo (g/h)	U.Venta
68968	<b>31,30</b>	1,7	123	1



## Cabezal soplete gas Profesional

Torche à caraméliser · Gasbrenner-Aufsatz  
Blow torch head · Queimadora a gás

Ref	€	W	Consumo (g/h)	U.Venta
68984	<b>16,50</b>	1,65	120	1



Válido para gas butano, NO gas natural  
Valid for butane gas, NOT natural gas

- Este cartucho contiene gas licuado a alta presión (LPG). Gas extremadamente inflamable. Mantenga el cartucho de gas fuera del alcance de los niños. No perforar el cartucho. Emplee el cartucho en un lugar ventilador. No inhale el gas. No deje el cartucho en un lugar que no sea estable. Mantener el cartucho de gas butano alejado de las llamas y el fuego, no exponga el cartucho al contacto directo con la luz solar o a temperaturas superiores a 40°C (104°F). Este cartucho de gas no se puede recargar. Asegúrese de que el cartucho este vacío antes de deshacerse de él.



- The cartridge contains high pressure liquefied petroleum gas (LPG). Highly flammable gas. Keep the cartridge out of reach of children. Do not puncture the cartridge. Use the cartridge in a well-ventilated place. Do not inhale the gas. Do not leave the cartridge in a place that is unstable. Keep the butane gas cartridge away from flames and fire. Do not expose the cartridge to direct sunlight or temperatures above 40°C (104°F). The gas cartridge is not refillable. Make sure the cartridge is empty before disposing of it.



## Cartucho de gas

Cartouche de gaz · Gaskartusche  
Gas cartridge · Cartucho de gás

Ref	€	ml	g	Pack	U.Venta
<b>A</b> 68941	<b>2,60</b>	420	220	1	1
<b>B</b> 68947	<b>10,10</b>	420 (x4)	220 (x4)	4	1

- Quemador de azúcar eléctrico redondo con soporte.
- Diseñado para aplicaciones en cocina y repostería profesional.
- Ideal para caramelizar crema.
- Se calienta muy rápido.

- Brûleur de sucre électrique rond avec soutien.
- Conçu pour les applications dans une cuisine professionnelle et des pâtisseries.
- Idéal pour caraméliser la crème.
- Il se réchauffe très vite.

- Round electric sugar burner with support.
- Designed for applications in professional kitchen and pastries.
- Ideal to caramelize cream.
- It heats up very fast.



Incluye soporte  
Includes support

## Quemador eléctrico redondo

Fer à caraméliser électrique rond · Karamellisierer rund  
Round electric caramélizer · Queimador eléctrico redondo

Ref	€	W	Ø (cm)	U.Venta
68651	<b>117,80</b>	650	Ø10	1
68652	<b>136,00</b>	1000	Ø12	1





## Dosificadores

INOX  
18/10



Dishwasher

- Ideal para rellenar o decorar platos con salsas y cremas calientes y frías.
- Sistema de palanca para un caudal ajustable; práctico y preciso.
- Sistema antigoteo y antisalpicaduras.
- Mango con diseño ergonómico que permite el manejo con una sola mano.
- Fácil desmontaje para una sencilla limpieza. Apto para el lavavajillas.

- Idéal pour remplir ou décorer les plats avec des sauces et des crèmes chaudes et froides.
- Système de levier pour un débit réglable; pratique et précis.
- Système anti-tôte et antisalpaduras.
- Mango avec conception ergonomique qui permet de manipuler d'une seule main.
- Démontage facile pour un nettoyage simple. Compatible pour le lave-vaisselle.

- Perfect for filling or decorating dishes with hot or cold sauces and cream.
- Its lever system for controlling the flow is practical and precise.
- Anti-drip and anti-splash system.
- The ergonomic handle means it can be used with just one hand.
- It's easy to disassemble for easy cleaning and it's dishwasher safe.

SI

Silicone

PE

Polyethylene



BPA free

### Dosificador Red

Entonnoir à decor · Dosierer  
Portionner · Dosificador

Ref	€	cm	h(cm)	L	U.Venta
67026	12,10	16x11	18	1,0	1



Marcas de medición (ml - cup)  
Measuring marks (ml - cup)

Sistema de gatillo para un caudal ajustable  
Trigger system for an adjustable flow

3  
Boquillas  
Nozzles



Sistema de gatillo para un caudal ajustable  
Trigger system for an adjustable flow

Incluye soporte y un platillo antigoteo  
Includes support and a drip dish

3  
Boquillas  
Nozzles



Sistema de gatillo para un caudal ajustable  
Trigger system for an adjustable flow

Incluye soporte  
Includes support

### Dosificador Inox

Entonnoir à decor · Dosierer  
Portionner · Dosificador

Ref	€	Ø (cm)	h(cm)	L	U.Venta
67150	63,30	19	27	2,0	1

### Dosificador Ration

Entonnoir à decor · Dosierer  
Portionner · Dosificador

Ref	€	L	U.Venta
67000	91,00	2,00	1

336

## Sifones



Dishwasher

- Robusto y duradero.
- Marcaje de llenado grabado en el exterior del cuerpo.
- Versátil: Diseñado para espumas frías y espumas calientes.
- Incluye 3 boquillas con formas decorativas.
- Funciona con cargas de gas (N2O).
- Cepillo limpiador para facilitar la limpieza.

- Robuste et durable.
- Marquage de remplissage gravé à l'extérieur du corps.
- Versatile : conçu pour des préparations froides et chaudes.
- Inclut 3 douilles des formes décoratives.
- Fonctionne avec des cartouches de gaz (N2O).
- Brosse pour faciliter le nettoyage.

- Robust and durable.
- Embossed filling marks on the outside.
- Versatile: designed for whipping up hot or cold foams.
- Includes 3 nozzles with decorative shapes.
- Charged with gas cartridges (N2O).
- Cleaning brush for easy cleaning.

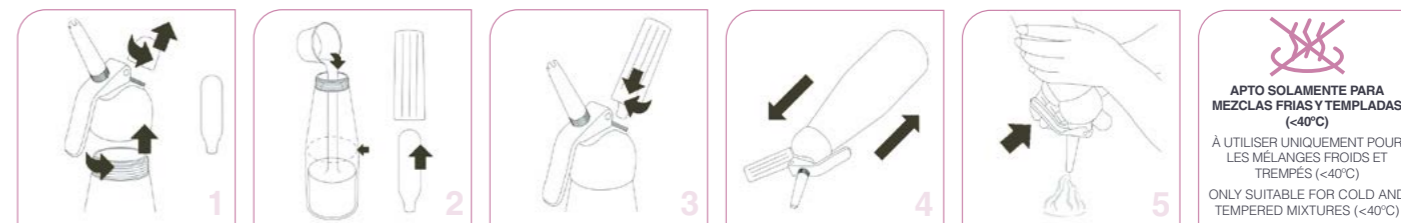

**APTO SOLAMENTE PARA MEZCLAS FRÍAS Y TEMPLADAS (<40°C)**  
À UTILISER UNIQUEMENT POUR LES MÉLANGES FROIDS ET TREPÉS (<40°C)  
ONLY SUITABLE FOR COLD AND TEMPERED MIXTURES (<40°C)

EXCLUSIVAMENTE PARA USO ALIMENTICIO  
EXCLUSIVELY FOR FOOD USE



### Cargas de sifón

Cartouches N<sub>2</sub>O pour siphon · N<sub>2</sub>O Kapsel für Sahnebereiter  
N<sub>2</sub>O cream charger · Botijas de sifão N<sub>2</sub>O

Ref	€	Botellas	Peso (g)	U.Venta
68402	8,50	10	8	1
68403	19,90	24	8	1

### Sifón Epicure

Siphon à crème · Sahnebereiter  
Cream whipper · Sifão creme

Ref	€	Ø (cm)	L	U.Venta
68300	111,00	9,0	0,50	1
68301	126,00	9,0	1,00	1

Temperatura de uso · Use temperature  
min = +5°C / max = +70°C

### Sifón Mix

Siphon à crème · Sahnebereiter  
Cream whipper · Sifão creme

Ref	€	Ø (cm)	L	U.Venta
68404	85,00	7,8x25	0,50	1
68405	97,70	9,3x32,5	1,00	1

Temperatura de uso · Use temperature  
min = +5°C / max = +40°C

PBT plastci

Aluminium

### Sifón White

Siphon à creme · Sahnebereiter  
Cream whipper · Sifão creme

Ref	€	Ø (cm)	L	U.Venta
68502	41,70	9x27	0,25	1
68500	49,40	9x31	0,50	1
68501	55,10	11x36	1,00	1

Temperatura de uso · Use temperature  
min = +5°C / max = +40°C

### Sifón black

Siphon à creme · Sahnebereiter  
Cream whipper · Sifão creme

Ref	€	Ø (cm)	L	U.Venta
68604	52,10	7,8x27,3	0,50	1
68605	57,40	9,3x32,5	1,00	1

Temperatura de uso · Use temperature  
min = +5°C / max = +40°C

**NUNCA ponga los sifones al baño maría, puede producirse una explosión con graves consecuencias.**  
**NE JAMAIS** mettez les siphons au bain marie car une explosion pourrait avoir lieu et provoquer de graves conséquences.  
**NEVER** put siphons in a water bath, as this may cause an explosion with serious consequences.

337



# Mangas repostería

PP Polypropylene  
INOX 18/10 Dishwasher  
BPA free

- Manga pastelera para decorar y personalizar tus postres preferidos.
- Manga de alta calidad. Soporta altas temperaturas.
- Resistente y reutilizable.
- Apta para el lavavajillas.

- Manga pastelera pour décorer et personnaliser vos desserts préférés.
- Manga de haute qualité. Il prend en charge des températures élevées.
- Résistant et réutilisable.
- Convient au lave-vaisselle.

- Pastelera manga to decorate and customize your favorite desserts.
- High quality manga. It supports high temperatures.
- Resistant and reusable.
- Suitable for dishwasher.

## Manga repostería

Poche à décorer · Spritzbeutel  
Pastry bag · Manga de pastelería

	Ref	€	cm	Ø (cm)	U.Venta
A	68972	7,50	20	20x30	1
B	68973	12,70	30	25x45	1



SI Silicone  
PP Polypropylene

## Manga repostería + boquillas

Poche à décorer · Spritzbeutel  
Pastry bag · Manga de pastelería

Ref	€	ml	h (cm)	U.Venta
68971	7,80	800	30	1

## Manga repostería

Poche à décorer · Spritzbeutel  
Pastry bag · Manga de pastelería

Ref	€	h(cm)	L	U.Venta
68930	5,20	30	0,57	6
68935	6,20	35	1,10	6
68940	6,80	40	1,45	6
68945	8,00	45	2,30	6
68950	8,80	50	2,50	6
68955	9,80	55	3,40	6
68960	11,00	60	5,50	6
68965	11,50	65	6,50	6
68970	13,90	70	7,50	6

**LDPE**  
Polyethylene  
Se adaptan a cualquier tipo de boquilla  
No emplear con alimentos a temperaturas superiores a 60°C  
Adapts to any kind of nozzle. Not for use with food at temperatures above 60°C

## Manga repostería desechables

Poche à décorer jetable · Einweg Spritzbeutel  
Non-returnable pastry bags · Mangas descartaveis

Ref	€	Piezas	AxB (cm)	U.Venta
68937	15,00	100	35x21	1
68939	21,60	100	40x22	1
68954	32,40	100	55x30	1
68964	37,90	100	65x32	1

Galga 280 = 70 micras (µm)



# Boquillas

INOX 18/10 Dishwasher



## Set de 6 boquillas redonda

Ensemble 6 douilles unies · Lochtüllensatz 6-tlg. rund  
6 plain tube set · Conjunto de 6 boquillas redonda

Ref	€	Ø (mm)	U.Venta
68908	26,10	8	1
68910	26,10	10	1
68912	26,10	12	1
68915	26,10	15	1

## Set de 6 boquillas estrella

Ensemble 6 douilles cannelées · Lochtüllensatz 6-tlg. Stern  
6 star tube set · Conjunto de 6 boquillas estrella

Ref	€	Ø (mm)	U.Venta
68928	26,10	8	1
68900	26,10	10	1
68932	26,10	12	1
68934	26,10	15	1

## Set de 6 boquillas rosa

Ensemble 6 douilles cannelées fermes · Tüllensatz 6-tlg. Stern  
6 close star tube set · Conjunto de 6 boquillas rosa

Ref	€	Ø (mm)	U.Venta
68948	26,10	8	1
68980	26,10	10	1
68942	26,10	12	1
68985	26,10	15	1



## Set de 6 boquillas redonda Size

Ensemble 6 douilles unies · Lochtüllensatz 6-tlg. rund  
6 plain tube set · Conjunto de 6 boquillas redonda

Ref	€	Forma (mm)
68996	17,00	Redonda 4/5/6/8/10/12

## Set de 6 boquillas estrella Size

Ensemble 6 douilles cannelées · Tüllensatz 6-tlg. Stern  
6 star tube set · Conjunto de 6 boquillas estrella

Ref	€	Forma (mm)
68997	17,00	Estrella 4/5/6/8/10/12

## Set de 6 boquillas rosa Size

Ensemble 6 douilles cannelées fermes · Tüllensatz 6-tlg.  
6 close star tube set · Conjunto de 6 boquillas rosa

Ref	€	Forma (mm)
68993	17,00	Rosa 4/6/8/10/12/15

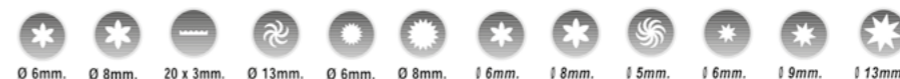

## Set de 6 boquillas variadas

Ensemble 6 douilles variées · Tüllensatz 6-tlg. sortiert  
6 assorted tube set · Conjunto de 6 boquillas variadas

Ref	€	Forma (mm)
68998	17,00	Rosa 6/8 Cinta 20x3 Cinta 20x3

## Set de 6 boquillas variadas Size

Ensemble 6 douilles variées · Tüllensatz 6-tlg. sortiert  
6 assorted tube set · Conjunto de 6 boquillas variadas

Ref	€	Forma (mm)
68999	17,00	Rosa 6/8 Hélice 5 Hélice 5

## Set de 6 boquillas relleno

Ensemble 2 douilles petit chou · Einfülltüllensatz 2-tlg.  
2 Bismark tube set · Conjunto de 2 boquillas relleno

Ref	€	Forma (mm)
68992	11,20	Relleno 4/8



AS Plastic Dishwasher

## Juego 6 boquillas rusas

Ensemble 6 douilles russes · 6-Tlg Russian Tüllensatz  
Set 6 Russian decorating nozzles · Conj. 6 boquillas russo

	Ref	€	Ø (cm)	h (cm)	U.Venta
A	68892	8,60	3,5	4,5	6
B	68893	14,90	3,0	6,2	1

## Set de 24 boquillas

24 pcs. douilles assorties · 24 tlg. Tüllensortiment  
24 pcs. anozzles set · Conjunto de 24 boquillas

Ref	€	Piezas	U.Venta
68994	15,60	24	1

INOX

## Juego de boquillas decoración

Deuilles assorties décoration · Dekorations-Tüllensatz  
Decorating nozzles · Jogo de boquillas decoração

Ref	€	Piezas	U.Venta
68991	17,00	26	1

# Pistolas

INOX  
18/10

- Ideal para salsas, cremas, aceites, aliños, vinagretas y todo tipo de condimentos líquidos.
- Dibuja, adorna y personaliza con estilo tus platos.

- Idéal pour les sauces, les crèmes, les huiles, les assaisonnements, les vinaigrettes et tout type de condiments liquides.
- Il dessine, décore et personnalise les plats.

- Ideal for sauces, creams, oils, dressings, vinaigrettes and all kinds of liquid condiments.
- Draw, decorate and personalize your dishes with style.



## Pistola decoración repostería

Pistolet Décoration Pâtisserie · Pistole für Tüllensätze  
Pastry Decoration Gun · Pistola Decoração Pastelaria

Ref	€	L	U.Venta
61407	33,50	0,25	1



## Juego pistola repostería

Pistolet pour pâtisserie · Pistole für Tüllensätze  
Cookie press cum icing set · Jogo de pistola pastelaria

Ref	€	L	U.Venta
68989	49,40	0,25	1

# Botellas biberón

PP PE  
Polypropylene Polyethylene  
BPA free

- Ideal para salsas, cremas, aceites, aliños, vinagretas y todo tipo de condimentos líquidos.
- Dibuja, adorna y personaliza con estilo tus platos.

- Idéal pour les sauces, les crèmes, les huiles, les vinaigrettes, les vinaigrettes et toutes sortes de condiments liquides.
- Dessinez, ornez et personnalisez vos plats.

- Ideal for sauces, creams, oils, dressings, vinaigrettes and all kinds of liquid condiments.
- Draw, adorn and customize your dishes.



SI  
Silicone  
BPA free

## Botella biberón Tri

Bouteille biberon · Dosierflasche  
Squeeze bottle · Garrafa

Ref	€	Ø (cm)	L	U.Venta
61974	4,10	7x20	0,45	6
61977	4,40	7x26	0,70	6

## Botella biberon Push

Bouteille biberon · Dosierflasche  
Squeeze bottle · Garrafa

Ref	€	Ø (cm)	L	U.Venta
61978	4,60	6x20	0,50	1
61979	4,70	7x20	0,60	1
61980	4,90	7x26	0,70	1

## Botella decoración

Biberon à décorer · Dekorierflasche  
Decorating pen · Garrafa decoração

Ref	€	Ø (cm)	L	U.Venta
64457	9,80	5,5x16	0,14	1

# Baño maría



Abertura lateral para llenar de agua (1,0 L)

Capacidad chocolate: 1,0 L

Side opening to introduce water (1,0 L)

Chocolatecapacity: 1,0 L



INOX  
18/10



## Cazo baño maría

Casserole bain marie · Stielkasserolle für Wasserbad  
Bain-marie saucepan · Çaçarol para banho-maria

Ref	€	Ø (cm)	h (cm)	L	U.Venta
62600	30,70	16	10,0	1,00	1



INOX  
18/10



## Baño maría chocolate Black

Bain marie de chocolat · Bain Marie topf für Schokolade  
Chocolate bain marie · Banho-maria chocolate

Ref	€	W	L	Temperatura	Medidas	U.Venta
69317	42,80	50	1,0	40-50°C	29 x 22 x 12 cm	1



INOX  
18/10



## Baño maría chocolate White

Bain marie de chocolat · Bain Marie topf für Schokolade  
Chocolate bain marie · Banho-maria chocolate

Ref	€	W	L	Temperatura	Medidas	U.Venta
69617	77,60	80	1,5	60°C	22,6x26x14,3 cm	1

- Cazo de doble pared para cocinar al baño maría.
- Fabricado en acero inoxidable 18/10 de máxima calidad.
- Doble pared: evita que el agua entre en contacto con el alimento.
- Abertura en el lateral para un llenado práctico y cómodo.
- Ideal para derretir chocolate, caramelo, emulsionar salsas, fundir mantequilla, etc.
- Mango de baquelita termorresistente.
- Apto para todos los fuegos (incluido la inducción).
- Fácil de usar y limpiar. Se puede lavar en lavavajillas.

- Double wall saucepan to cook in the water bath.
- Made of stainless steel 18/10 of maximum quality.
- Double wall: prevents water from contacting food.
- Opening on the side for a practical and comfortable filling.
- Ideal for melting chocolate, caramel, emulsifying sauces, melt butter, etc.
- Thermor resistant baquelita mango.
- Suitable for all fires (including induction).
- Easy to use and clean. It can be washed in a dishwasher.



- Recipiente eléctrico con cazo desmontable de acero inoxidable de gran calidad.
- Dos funciones: fundir el chocolate (40-50°C) y mantenerlo caliente.
- Botón giratorio con 3 posiciones: apagar, fundir y calentar.
- Mantiene la temperatura constante a 40 - 50 grados.

- Récipient électrique avec acier inoxydable amovible en acier inoxydable de haute qualité.
- Deux fonctions: Faire fondre le chocolat (40-50°C) et le garder chaud.
- Bouton rotatif avec 3 positions: éteignez, faites fondre et chauffez.
- Maintenir la température constante à 40 à 50 degrés.
- Electric container with removable stainless steel of high quality stainless steel.

- Two functions: melt the chocolate (40-50°C) and keep it hot.
- Rotating button with 3 positions: turn off, melt and heat.
- Maintain the constant temperature at 40 - 50 degrees.

- Perfecta para elaborar coberturas de alta calidad y mantenerlas a la temperatura deseada durante horas.
- Ideal para la obtención de un glaseado brillante para pasteles, tartas, cake pops, muffins, etc.
- Contenedor GN1/6 (1,50L) y tapa extraíble de acero inoxidable 18/10 para garantizar una rápida y efectiva limpieza (aptos para el lavavajillas).
- Regulación de temperatura por termostato de 0°C a 60°C.
- Calentamiento 3D; el calor se distribuye de manera uniforme por toda la superficie del recipiente.
- Luz indicadora, se enciende tan pronto como se alcanza la temperatura deseada.
- Compatible con cubetas GN1/6 de Lacor

- Perfect to prepare high quality coverage and keep them at the desired temperature for hours.
- Ideal for obtaining a brilliant glaze for cakes, cakes, cake pops, muffins, etc.
- GN1/6 (1.50L) container and removable stainless steel cover 18/10 to guarantee rapid and effective cleaning (suitable for dishwasher).
- Temperature regulation by thermostat from 0°C to 60°C.
- 3D heating; The heat is distributed uniformly throughout the surface of the container.
- Indicator light, comes as soon as the desired temperature is reached.
- Compatible with Gn1/6 buckets from Lacor

# Rejillas repostería



**CRO**  
Cromado  
Chrome  
Dishwasher

**INOX**  
18/10  
Dishwasher

## Rejilla para repostería redonda

Grille pâtisserie · Kuchengitter rund  
Pastry rack · Grelha para pasteleria

Ref	€	Ø (cm)	U.Venta
66916	6,40	28	6
66926	6,50	32	6
66917	8,50	36	6
66927	8,70	43x30	6

## Portartas Inox

Gueridon pâtisier · Kuchenplatte  
Cake stand · Porta-tartes

Ref	€	Ø (cm)	U.Venta
67030	178,10	30	1



**MF**  
Melamine  
Dishwasher  
BPA free

**INOX**  
18/10  
Dishwasher

**INOX**  
18/10  
Dishwasher

## Portartas Melamina

Gueridon pâtisier · Kuchenplatte  
Cake stand · Porta-tartes

Ref	€	Ø (cm)	h(cm)	U.Venta
63586	33,40	30	9,0	4

## Pinza repostería

Pince à gateau · Gebäck-Tortenzange  
Cake tong · Pinça pastelaria

Ref	€	Largo (cm)	U.Venta
62317	12,00	20	1

## Pinza repostería con anillas

Pince à gateau · Gebäck-Tortenzange  
Cake tong · Pinça pastelaria

Ref	€	Largo (cm)	U.Venta
68008	6,10	16	6

Porción de tarta  
Slice of cake

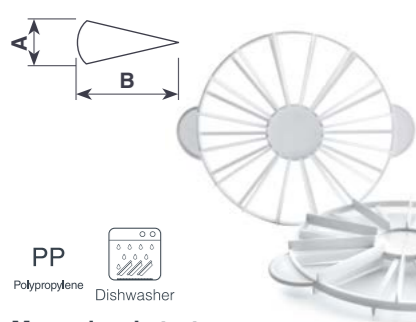

Situar · Marcar · Repartir  
Place · Mark · Partitioning

**PP**  
Polypropylene  
Dishwasher

## Marcador de tartas

Marqueur à gateaux · Tortenteiler  
Cake marker · Marcador de bolos

Ref	€	Ø (cm)	AxB (cm)	Porciones	U.Venta
68511	9,00	27	8,5x13,5 / 7,5x13,5	10 / 12	1
68513	9,00	27	6x13,5 / 5,5x13,5	14 / 16	1

## Espátula para galletas Tasty

Spatule à biscuits · Spachtel für Kekse  
Biscuit spatula · Espátula para biscoitos

Ref	€	cm	Largo (cm)	U.Venta
68805	5,10	16,8x11	32,5	1

Diseñada para recoger varias galletas a la vez.  
Designed to scoop up several biscuits at the same time.

Nylon, no raya  
Nylon, not scratch,



# Racionador de helados

**INOX**  
18/10  
Dishwasher

- Utensilio de repostería perfecto para formar bolas de helado sin esfuerzo.
- Mecanismo de estilo guillotina para extraer y servir fácilmente bolas de helado.
- Gran resistencia y durabilidad.
- Fácil de usar y limpiar. Apto para lavavajillas.

- Ustensile de pâtisserie parfait pour faire des boules de glace sans efforts.
- Mécanisme de style guillotine pour extraire et servir facilement les boules de glace.
- Grande résistance et durabilité.
- Facile à utiliser et à nettoyer. Apte pour le lave-vaisselle.

- A perfect confectionery utensil for making balls of ice cream effortlessly.
- Guillotine style mechanism for easily scooping and serving balls of ice cream.
- Very strong and durable.
- Easy to use and clean. Dishwasher safe.

Fundición de inoxidable  
Stainless cast iron



Fundición de inoxidable  
Stainless cast iron



## Racionador Profesional

Cuillère à glace professionnel · Eisportionierer, Profi  
Professional ice cream scoop · Racionador profesional

Ref	€	Bolas/L	Ø (mm)	U.Venta
67038	34,40	50	39	10
67043	34,40	40	44	10
67045	35,30	36	46	10
67047	35,30	30	48	10
67049	35,30	24	50	10
67052	36,60	20	53	10
67055	36,60	16	56	10
67058	36,60	13	59	10
67062	36,60	12	63	10
67065	36,60	10	66	10
67069	36,70	8	70	10
67074	36,70	7	75	10
67084	36,70	5	85	10

## Racionador oval Profesional

Cuillère à glace ovale · Eisportionierer  
Ice cream scoop oval · Racionador oval

Ref	€	Bolas/L	Ø (mm)	U.Venta
67153	36,40	40	10	
67158	36,40	30	10	
67163	36,40	20	10	

## Racionador Basic

Cuillère à glace · Eisportionierer  
Ice cream scoop · Racionador de gelado

Ref	€	Bolas/L	Ø (mm)	U.Venta
67039	18,30	50	39	10
67044	18,30	40	44	10
67046	18,30	36	46	10
67048	18,30	30	48	10
67050	18,30	24	50	10
67053	18,60	20	53	10
67056	19,30	16	56	10
67059	19,30	13	59	10
67063	19,30	12	63	10
67066	19,70	10	66	10
67070	19,70	8	70	10

**AL**  
Aluminium



## Racionador de helado aluminio

Cuillère à glace aluminium · Eisportionierer, Aluminium  
Aluminium ice cream scoop · Racionador de gelado aluminio

Ref	€	Bolas/L	Ø (mm)	U.Venta
67090	9,90	50	50	1

## Copa baja

Coupe à glace basse · Eiskelch  
Ice cream cup · Taça de gelado

Ref	€	Bolas/L	cm	U.Venta
67002	4,90	5,5	Ø9x12	12

# Moldes y aros

## Moulds and rings



## Colección Black



100%  
Platinum  
silicone

- Molde 100% de silicona platino para procesos de horneado y congelación.
- Antiadherente, flexible, duradero, higiénico y fácil de limpiar.
- Soporta fuertes cambios de temperatura.
- No transmite sabores ni olores.
- Permite desmoldar fácil y perfectamente los alimentos.

- Moule de silicone en platine 100% pour les processus de cuisson et la congélation.
- Anticiting, flexible, durable, hygiénique et facile à nettoyer.
- Il prend en charge de forts changements de température.
- Il ne transmet pas les saveurs ou les odeurs.
- Il permet des aliments facilement et parfaitement imprégnés.

- 100% platinum silicone mold for baking processes and freezing.
- Antiating, flexible, durable, hygienic and easy to clean.
- It supports strong temperature changes.
- It does not transmit flavors or odors.
- It allows to easily and perfectly unmold food.

**Antiadherentes, flexibles, duraderos, higiénicos y fáciles de limpiar**  
Non-stick, flexible, long-lasting, hygienic and easy to clean



### Briochette 24 cavidades

Briochette 24 cavités · Briocheform für 24 Madaleine  
Briochette 24 moulds · Briochette 24 cavidades

Ref	€	Ø (cm)	h(cm)	ml	U.Venta
66760	102,90	8	3,5	84	1



### Semiésferica 28 cavidades

Hemispher 28 cavités · Halbkugelform für 28 Madaleine  
Half-spheres 28 moulds · Semi-esférica 28 cavidades

Ref	€	Ø (cm)	h(cm)	ml	U.Venta
66761	102,90	7	3,5	90	1



### Semiésferica 60 cavidades

Hemispher 60 cavités · Halbkugelform für 60 Madaleine  
Half-spheres 60 moulds · Semi-esférica 60 cavidades

Ref	€	Ø (cm)	h(cm)	ml	U.Venta
66747	101,00	4,2	2	10	1



### Mini semiésferica 96 cavidades

Mini Hemispher 96 cavités · Mini Halbkugelform für 96 Madaleine  
Mini Half-spheres 96 moulds · Mini semi-esférica 96 cavidades

Ref	€	Ø (cm)	h(cm)	ml	U.Venta
66762	102,90	3,5	1,75	11	1



### Madalena 44 cavidades

Madeleine 44 cavités · Madeleineform für 44 Madaleine  
Madeleine 44 moulds · Madalena 44 cavidades

Ref	€	cm	h(cm)	ml	U.Venta
66763	102,90	7,7x4,5	1,8	30	1



### Florentina 15 cavidades

Florentine 15 cavités · Florentinerform für 15 Madaleine  
Florentina 15 moulds · Florentina 15 cavidades

Ref	€	Ø (cm)	h(cm)	ml	U.Venta
66748	101,00	10	2	100	1



### Mini Muffin 70 cavidades

Mini muffin 70 cavités · Mini Muffinform klein für 70 Madaleine  
Mini muffin 70 moulds · Mini muffin 70 cavidades

Ref	€	Ø (cm)	h(cm)	ml	U.Venta
66765	102,90	4,5	3	40	1



### Florentina 40 cavidades

Florentine 40 cavités · Florentinerform für 40 Madaleine  
Florentina 40 moulds · Florentina 40 cavidades

Ref	€	Ø (cm)	h(cm)	ml	U.Venta
66764	102,90	6	1,1	25	1

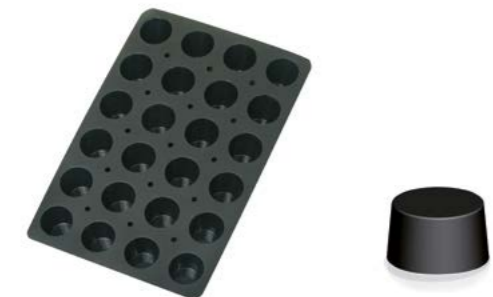

### Muffin 24 cavidades

Muffin 24 cavités · Muffinform für 24 Madaleine  
Muffin 24 moulds · Muffin 24 cavidades

Ref	€	Ø (cm)	h(cm)	ml	U.Venta
66766	102,90	7	4	120	1



### Tartaleta 60 cavidades

Tartalette 60 cavités · Torteileitform für 60 Madaleine  
Tartlet 60 moulds · Tarte 60 cavidades

Ref	€	Ø (cm)	h(cm)	ml	U.Venta
66767	102,90	4,5	1	10	1

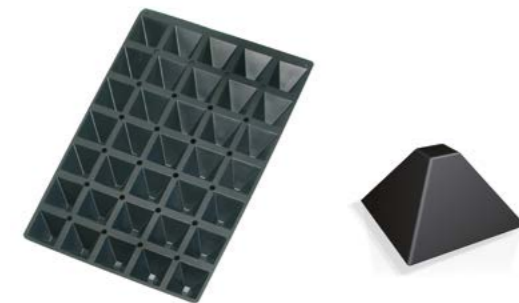

### Pirámide 35 cavidades

Pyramide 35 cavités · Pyramidenform für 35 Madaleine  
Pyramid 35 moulds · Pirámide 35 cavidades

Ref	€	cm	h(cm)	ml	U.Venta
66768	102,90	6,5x6,5	3,5	61	1



### Mini cake 30 cavidades

Mini cake 30 cavités · Mini Kuchenform für 30 Madaleine  
Mini cake 30 moulds · Mini cake 30 cavidades

Ref	€	cm	h(cm)	ml	U.Venta
66769	102,90	10x5	3	110	1

# Colección Pastryflex

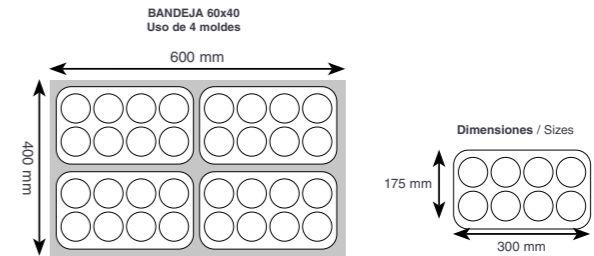
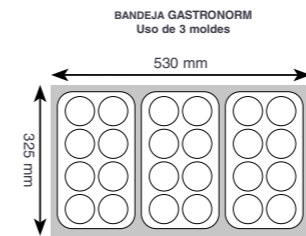

### Cilindro 8 cavidades

Cylindre 8 cavités · Zylinderform für 8 Madeleine  
Cylindre 8 moulds · Cilindro 8 cavidades

Ref	€	Ø (cm)	h(cm)	ml	U.Venta
66807	16,00	6	3,5	90	1



### Madalena pequeña 15 cavidades

Petite madeleine 15 cavités · Madeleineform, Klein, für 15 Madeleine  
Small madeleine 15 moulds · Madalena pequena 15 cavidades

Ref	€	cm	h(cm)	ml	U.Venta
66816	16,00	4,2x3	1,15	10	1



### Madalena 9 cavidades

Madeleine 9 cavités · Madeleineform 9 Madeleine  
Madeleine 9 moulds · Madalena 9 cavidades

Ref	€	cm	h(cm)	ml	U.Venta
66817	16,00	7,8x4,5	1,7	30	1



### Briochette cónico 6 cavidades

Briochette 6 cavités · Briocheform 6 Madeleine  
Briochette 6 moulds · Briochette 6 cavidades

Ref	€	Ø (cm)	h(cm)	ml	U.Venta
66819	16,00	10,5	2	110	1



### Briochette 6 cavidades

Briochette 6 cavités · Briocheform 6 Madeleine  
Briochette 6 moulds · Briochette 6 cavidades

Ref	€	Ø (cm)	h(cm)	ml	U.Venta
66820	16,00	8	3	110	1



### Semiésférica 24 cavidades

Hemispher 24 cavités · Halbkugelform 24 Madeleine  
Half-spheres 24 moulds · Semi-esférica 24 cavidades

Ref	€	Ø (cm)	h(cm)	ml	U.Venta
66800	16,00	3	1,7	10	1



### Semiésférica 15 cavidades

Hemispher 15 cavités · Halbkugelform 15 Madeleine  
Half-spheres 15 moulds · Semi-esférica 15 cavidades

Ref	€	Ø (cm)	h(cm)	ml	U.Venta
66801	16,00	4	2	20	1



### Semiésférica 6 cavidades

Hemispher 6 cavités · Halbkugelform 6 Madeleine  
Half-spheres 6 moulds · Semi-esférica 6 cavidades

Ref	€	Ø (cm)	h(cm)	ml	U.Venta
66802	16,00	7	3,5	80	1

### Pirámide 6 cavidades

Pyramide 6 cavités · Pyramideform 6 Madeleine  
Pyramid 6 moulds · Pirámide 6 cavidades

Ref	€	cm	h(cm)	ml	U.Venta
66822	16,00	71x71	4	90	1



### Muffin 6 cavidades

Muffin 6 cavités · Muffinform 6 Madeleine  
Muffin 6 moulds · Muffin 6 cavidades

Ref	€	Ø (cm)	h(cm)	ml	U.Venta
66805	16,00	7	4	100	1



### Mini muffin 11 cavidades

Mini muffin 11 cavités · Muffinform klein für 11 Madeleine  
Mini muffin 11 moulds · Mini muffin 11 cavidades

Ref	€	Ø (cm)	h(cm)	ml	U.Venta
66804	16,00	5	2,8	50	1



### Corazón 8 cavidades

Coeur 8 cavités · Herzform 8 Madeleine  
Heart 8 moulds · Coração 8 cavidades

Ref	€	cm	h(cm)	ml	U.Venta
66824	16,00	6,5x6	3,5	90	1



### Rectángulo pequeño 20 cavidades

Petit rectangle 20 cavités · Form rechteckig für 20 Madeleine  
Petit-four 20 moulds · Rectángulo pequeno 20 cavidades

Ref	€	cm	h(cm)	ml	U.Venta
66825	16,00	5x2,5	1,1	20	1



### Cake 12 cavidades

Cake 12 cavités · Kuchenform 12 Madeleine  
Cake 12 moulds · Cake 12 cavidades

Ref	€	cm	h(cm)	ml	U.Venta
66826	16,00	8x3	3	70	1



### Mini savarín 18 cavidades

Mini savarín 18 cavités · Savarinform 18 Madeleine  
Mini savarín 18 moulds · Mini savarín 18 cavidades

Ref	€	Ø (cm)	h(cm)	ml	U.Venta
66808	16,00	4	1,2	18	1



### Molde flan 6 cavidades

Moule à flan 6 cavités · Madeleine Backform für 6 Madeleine  
Creme caramel 6 moulds · Molde de flan 6 cavidades

Ref	€	cm	h(cm)	L	U.Venta
66736	22,40	29x19	5	0,16	1



### Molde cake

Moule à cake · Kuchenform  
Cake mould · Molde cake

Ref	€	cm	h(cm)	L	U.Venta
66733	22,20	24x10	6,5	1,50	1
66742	24,30	26x10	7,0	1,55	1



### Molde savarín bajo

Moule Savarín bas · Savarinform, klein  
Low Savarín mould · Molde pudín baixo

Ref	€	Ø (cm)	h(cm)	L	U.Venta
66734	22,40	24	6	1,25	1



### Molde savarín alto

Moule Savarín haut · Savarinform, gross  
High Savarín mould · Molde pudín alto

Ref	€	Ø (cm)	h(cm)	L	U.Venta
66735	24,40	22	11	2,20	1



### Molde redondo

Moule à manqué · Tortenform  
Round cake mould · Molde redondo

Ref	€	Ø (cm)	h(cm)	L	U.Venta
66737	21,80	24	4,5	1,70	1
66738	22,40	26	4,5	2,20	1



## Colección Platinum



Click here



### Set de 2 moldes donuts

Ensemble de 2 moules à donuts · Set mit 2 Donut-Formen  
Set of 2 doughnut moulds · Conjunto de 2 moldes para donuts

Ref	€	Ø (cm)	h(cm)	L	U.Venta
68770	17,40	7,0	2	0,07	1

### Molde donuts

Moules à donuts · Donut-Formen Zweier  
Doughnut moulds · Molde para donuts

Ref	€	Ø (cm)	h(cm)	L	U.Venta
68760	8,70	7,0	2	0,07	1

## Molde desmontable



### Molde desmontable redondo

Moule demontable · Backform, zerlegbar  
Dismountable mould · Molde desmontável

Ref	€	Ø (cm)	h(cm)	L	U.Venta
66775	23,10	25	7,5	2,0	1

\* 66778 18,00 20 7,5 1,6 1 **Acabado mate** · Matt finish

\* Apto para la freidora de aire (69511) · Suitable for air fryer (69511)

### Molde desmontable rectangular

Moule demontable · Backform, zerlegbar  
Dismountable mould · Molde desmontável

Ref	€	cm	h(cm)	L	U.Venta
66776	22,40	29x13	7,0	1,5	1

**Acabado brillo** · Gloss finish

### Molde desmontable cuadrado

Moule demontable · Backform, zerlegbar  
Dismountable mould · Molde desmontável

Ref	€	cm	h(cm)	L	U.Venta
66777	26,10	25x25	7,5	2,5	1

**Acabado brillo** · Gloss finish

Ref	€	cm	h(cm)	L	U.Venta
66779	21,60	18x18	7,0	2,3	1

**Acabado mate** · Matt finish



# Moldes, tapetes y láminas



**Apto para todas las freidoras de aire**  
Suitable for all air fryers



**Set 12 moldes muffin silicona**  
Set 12 moules muffin · Set 12 Muffin formen  
12 muffin moulds set · Conj. 12 moldes muffin

Ref	€	Ø (cm)	h(cm)	U.Venta
66745	5,70	7	5	1



**Flexible, antiadherente y reutilizable**  
Flexible, non-stick and reusable

30 macarons -> 5cm  
48 macarons -> 4cm



**Molde macarons doble**  
Moule macarons double · Doppel Macaronsform  
Macarons dual mould · Molde macarons duplo

Ref	€	cm	U.Venta
66753	12,90	39x29	1

**Flexible, antiadherente y reutilizable**  
Flexible, non-stick and reusable

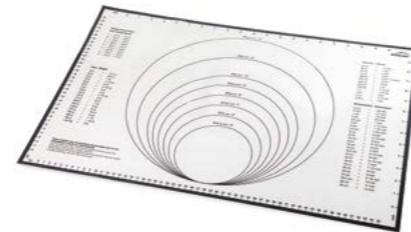

**Tapete de silicona impreso**  
Tapis en silicone imprime · Bedruckte Silikonmatte  
Printed silicon mat · Tapete de silicone impreso

Ref	€	cm	U.Venta
66759	29,70	60x40	1

**Flexible, antiadherente y reutilizable**  
Flexible, non-stick and reusable



**Tapete silicona White**  
Tapis en silicone · Backblech-Auflage Silikon  
Silicone covering · Tapete de silicone

Ref	€	cm	U.Venta
66749	20,80	30x40	1
66731	28,90	60x40	1
66732	21,40	52x32	1

new

**Tapete microperforado White**  
Tapis microperforé · Mikro-perforierte Matte  
Micro-perforated mat · Tapete microperforado

Ref	€	cm	U.Venta
66794	8,20	30x40	1
66796	15,60	60x40	1
66799	11,10	GN 1/1	1

**Flexible, antiadherente y reutilizable**  
Flexible, non-stick and reusable

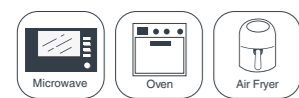

**Fácil de cortar**  
Easy to cut

3 pcs



- Papel de horno para freidora de aire, horno, deshidratador y moldes repostería.
- Hoja de cocción fabricada en fibra de vidrio.
- Reutilizable, más de 1.000 hornados.
- 100% flexible, se adapta a todo tipo de cestillos, moldes, bandejas, etc.
- Antiadherente por ambos lados.
- Medidas: 30x40 cm. Soporta temperaturas hasta 250°C. Libre de PFOA.

- Friries à air, four, déshydrateur et papier de cuisson à cuisson.
- Fiche de cuisson fabriquée en fibre de verre.
- Réutilisable, plus de 1 000 cuits au four.
- 100% flexible, s'adapte à tous les types de paniers, moules, plateaux, etc.
- Uniabutor des deux côtés.
- Mesures: 30x40 cm. Prend en charge les températures jusqu'à 250 ° C. PFOA gratuit.

- Air frying, oven, dehydrator and baking baking paper.
- Cooking sheet manufactured in fiberglass.
- Reusable, more than 1,000 baked.
- 100% flexible, adapts to all types of baskets, molds, trays, etc.
- Uniabutor on both sides.
- Measures: 30x40 cm. Supports temperatures up to 250°C. PFOA free.

**Láminas antiadherentes**  
Feuilles antiadhésif · Antihft-Blätter  
Non-stick sheets · Láminas antiaderentes

Ref	€	cm	Unidad	U.Venta
66746	10,10	30x40	3	1

# Parrillas, placas y pinzas



**Varilla** · Rod: Ø2 mm

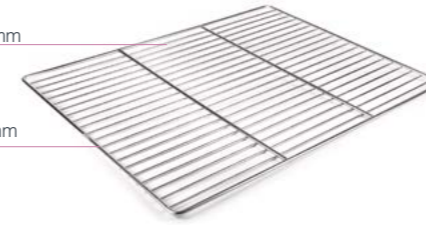

**Varilla** · Rod: Ø5 mm

**Parrilla Due**

Grille · Gitter, Rost  
Grate · Grelha

Ref	€	cm	h(cm)	U.Venta
68741	30,60	60x40	0,8	1

AL  
Aluminium

**Placa horno antiadherente**

Plaque à four aluminium anti-adhésif teflon · Backblech, Aluminium, Teflon  
Teflon non-stick coated oven aluminium tray · Placa forno alumínio anti-aderente

Ref	€	cm	h(cm)	U.Venta
68660	38,20	60x40	1,0	1
68659	34,70	GN 1/1	1,0	1

**Placa horno inox**

Plaque à four · Backblech  
Baking sheet · Placa de forno

Ref	€	cm	h(cm)	U.Venta
68740	45,40	60x40	0,8	1
68739	35,10	GN 1/1	0,8	1

INOX 200°C  
Max

**Pinza para bandeja GN**

Pince inox pour bac Gastronorm · Zange für GN Behälter  
Tong GN tray · Pinça para forno e bandejas GN

Ref	€	Largo (cm)	U.Venta	
62989	17,50	20	12	
62998	17,50	20	12	Con silicona · With silicone



**Parrilla Tri**

Grille · Gitter, Rost  
Grate · Grelha

Ref	€	cm	Medidas Cubeta	U.Venta
66920	55,10	65x53	2/1	1
66921	21,20	53x32,5	1/1	1

FE  
Iron

**Placa horno Black**

Plaque à four tôle noire · Backblech, Schwarzstahl  
Baking sheet black steel · Placa de forno aço negro

Ref	€	cm	h(cm)	U.Venta
68640	37,60	60x40	0,8	1

AL  
Aluminium

**Placa horno Aluminium**

Plaque à four · Backblech  
Baking sheet · Placa de forno

Ref	€	cm	h(cm)	U.Venta
68641	35,60	60x40	0,8	1
68642	28,80	GN 1/1	0,8	1



# Colección Inox

INOX 18/10 240°C Max  
 Gas Microwave Oven Freezer Dishwasher



## Cadena repostería

Chaîne pour pâtisserie · Kette für Konditorei  
 String for pastry · Corrente para pastelería

Ref	€	Largo (cm)	U.Venta
68248	12,30	1,80	12



## Molde 1/2 caña desmontable redondo

Gouttière à bûche · Terrinen-/Kuchenform "Dachrinne",  
 Round cake mould · Molde 1/2 cana desmontável redondo

Ref	€	cm	h(cm)	U.Venta
68001	40,30	25x9	6,0	1
68002	50,40	50x9	6,0	1



## Marco rectangular

Rectangle · Rahmen, rechteckig,  
 Rectangular frame · Molde rectangular

Ref	€	cm	h(cm)	U.Venta
68043	31,00	30x40	3,0	1
68041	31,20	30x40	5,0	1
68048	31,20	31x48	3,0	1
68049	32,60	31x48	5,0	1
68060	34,10	40x60	3,0	1
68061	35,30	40x60	5,0	1

## Flanero

Moule à flan · Pudding-/Becherförmchen  
 Pudding mould · Forma flan

Ref	€	Ø (cm)	h(cm)	ml	U.Venta
60007	4,40	7	5,0	100	10
60008	5,30	8	5,3	200	10



## Molde 1/2 caña desmontable triangular

Moule triangle "demie canne" · Terrinen-/Kuchenform "Dachrinne",  
 Three-cornered cake mould · Molde 1/2 cana desmontável triangular

Ref	€	cm	h(cm)	U.Venta
68003	39,20	25,5x9,4	9,4	1
68004	49,10	50,7x9,4	9,4	1



## Bandeja

Plaque · Backblech  
 Baking sheet · Bandeja

Ref	€	cm	h(cm)	U.Venta
68030	40,10	30x40	1,0	1
68031	40,50	31x48	1,0	1
68040	71,50	40x60	1,0	1

# Moldes aluminio

AL 250°C Max  
 Aluminium Gas Microwave Oven Freezer Dishwasher ECO PFOA Free

- Amplia gama de moldes de aluminio con antiadherente para horno.
- Resistente a altas temperaturas, excelente conductor de calor.
- Recubrimiento antiadherente por toda la superficie de la pieza

- Large gamme de moules pour four en aluminium avec antiadhésif.
- Résistant à de hautes températures, excellent conducteur de chaleur.
- Revêtement antiadhésif sur toute la surface de la pièce.

- Wide range of non-stick aluminium moulds for the oven.
- Resistant to high temperatures, excellent heat conductor.
- The entire surface of the mould has a non-stick coating.



## Set 4 flaneros

Jeu 4 Moule à flan · 4 Pudding-/Becherförmchen  
 4 pcs. pudding mould · Conjunto 4 formas flan

Ref	€	Ø (cm)	h(cm)	U.Venta
68808	14,80	8	5,2	6

## Molde Cake

Moule à cake · Kuchenform, konisch  
 Cake mould · Molde cake

Ref	€	Largo (cm)	h(cm)	U.Venta
68825	12,50	25	7	6
68831	14,70	30	7	6
68835	15,80	35	7	6

## Molde alto

Moule à manque · Käsekuchenform  
 Pie mould · Molde alto

Ref	€	Ø (cm)	h(cm)	U.Venta
68822	10,50	22	4,7	6
68827	11,40	26	5,0	6
68829	13,20	30	5,0	6
68833	14,40	32	5,2	6



## Molde rizado

Moule à tarte fond fixe · Tortenbodenform, gewellter Rand.  
 Tart mould · Molde frizado

Ref	€	Ø (cm)	h(cm)	U.Venta
68723	11,20	24	3,7	6
68729	12,60	28	3,7	6
68732	13,40	32	3,7	6



## Molde rizado movil

Moule à tarte fond mobile · Kuchenform, konisch  
 Fruit tart mould · Molde frizado-fundo móvil

Ref	€	Ø (cm)	h(cm)	U.Venta
68842	12,80	24	3	6
68882	17,00	28	3	6
68823	21,00	32	3	6



## Flanero rizado

Moule à brioche · Briocheform  
 Brioche mould · Molde flan frizado

Ref	€	Ø (cm)	h(cm)	U.Venta
68810	5,70	10	4,0	6
68814	7,70	14	5,5	6
68818	8,60	18	6,5	6
68821	11,70	22	10	6

## Molde savarin

Moule à Savarin · Reistrand/Savarinform  
 Savarin mould · Molde pudim

Ref	€	Ø (cm)	h(cm)	U.Venta
68724	17,60	24x6,5	5,7	6
68862	19,00	26x6,5	6,0	6
68863	19,30	28x6,5	6,0	6



## Molde pizza

Moule à pizza · Pizzablech  
 Pizza mould · Molde pizza

Ref	€	Ø (cm)	h(cm)	U.Venta
68824	10,20	24	1,8	6
68828	10,90	28	1,8	6
68832	13,60	32	2,0	6
68836	15,30	36	2,0	6



## Molde pizza perforado

Moule à pizza perforé · Pizzablech, gelocht  
 Perforated Pizza mould · Molde pizza perforado

Ref	€	Ø (cm)	h(cm)	U.Venta
67824	11,70	24	1,8	6
67828	12,40	28	1,8	6
67832	13,20	32	2,0	6
67836	14,00	36	2,0	6





## Colección Delize

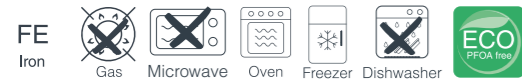

- Fabricado en acero al carbono.
- Antiadherente interior y exterior de máxima calidad, ecológico y libre de PFOA.
- La base desmontable y el clip lateral garantizan un mejor desmoldado y una mayor facilidad de uso.
- Resistente a altas temperaturas.
- Fondo rugoso para una distribución uniforme y retención del calor.
- Apto para el horno, nevera y congelador.

- Fabriqué en acier au carbone.
- Antiseurs intérieurs et extérieurs de la plus haute qualité, écologique et exempte de PFOA.
- La base amovible et le clip latéral garantissent une meilleure masse et une plus grande facilité d'utilisation.
- Températures élevées résistantes.
- Contexte robuste pour la distribution uniforme et la rétention de chaleur.
- Convient pour le four, le réfrigérateur et le congélateur.

- Manufactured in carbon steel.
- Interior and exterior antiating of the highest quality, ecological and free of PFOA.
- The removable base and the lateral clip guarantee a better unmolding and greater ease of use.
- High temperatures resistant.
- Rugged background for uniform distribution and heat retention.
- Suitable for the oven, fridge and freezer.



### Molde desmontable

Moule demontable · Kuchenform  
Dismountable mould · Molde desmontável

Ref	€	Ø (cm)	h(cm)	L	U.Venta
68676	7,90	18	6,8	1,50	1
68680	8,30	20	6,8	1,90	1
68684	9,60	24	6,8	2,80	1
68686	10,20	26	6,8	3,30	1
68688	11,20	28	6,8	3,80	1
68696	12,00	16	13	2,00	1

### Molde baguette

Moule à baguette · Baguette-Form  
Baguette mould · Molde para baguetes

Ref	€	cm	h(cm)	Compartimentos	U.Venta
68450	11,40	38x31,5	2,6	4	1

### Molde cake

Moule à cake · Kuchenform, konisch  
Cake mould · Molde cake

Ref	€	cm	h(cm)	L	U.Venta
68451	6,30	25x11,5	7,0	1,60	1
68452	7,30	31x11,5	7,0	1,90	1
68453	8,80	35,6x11,5	7,0	2,25	1



### Molde alto

Moule à manque · Käsekuchenform  
Pie mould · Molde alto

Ref	€	Ø (cm)	h(cm)	L	U.Venta
68455	6,10	24	4,5	1,50	1
68456	7,90	28	4,5	2,00	1



### Molde rizado alto

Moule à tarte fond fixe · Tortenbodenform, gewellter Rand.  
Tart mould · Molde frizado

Ref	€	Ø (cm)	h(cm)	L	U.Venta
68797	9,70	20	5,0	1,25	1
68798	10,30	24	5,0	1,90	1
68799	12,80	28	5,0	2,80	1
68787	10,10	20	5,0	-	1
68788	11,00	24	5,0	-	1
68789	13,20	28	5,0	-	1



#### COMPOSICIÓN:

- Bandeja: 38,2x26x1,5 cm
- Molde muffin: 33,5x20,5x3 cm (0,98 L)
- Molde cuadrado: 24x22x5,5 cm (2,01 L)
- Molde cake: 24x12x5,5 cm (0,90 L)
- Rustidera: 38,2x26x5 cm (3,40 L)

### Set 5 moldes

Ensemble de 5 moules · Satz mit 5 Förmchen  
Set of 5 moulds · Conjunto de 5 moldes

Ref	€	Piezas	U.Venta
68461	40,00	5	1



### Molde savarin

Moule à Savarin · Reisrand/Savarinform  
Savarin mould · Molde pudim

Ref	€	Ø (cm)	h(cm)	L	U.Venta
68454	11,20	26	8,6	2,15	1

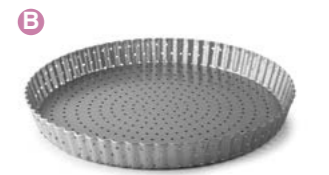

### Molde rizado

Moule à tarte fond fixe · Tortenbodenform, gewellter Rand.  
Tart mould · Molde frizado

Ref	€	Ø (cm)	h(cm)	L	U.Venta
68790	4,50	14	2,5	0,30	1
68791	6,60	20	2,5	0,60	1
68792	8,50	24	2,8	1,00	1
68793	9,10	26	2,8	1,20	1
68794	9,70	28	3,0	1,45	1
68795	10,70	30	3,0	1,50	1
68796	11,50	32	3,0	1,70	1
68780	4,80	14	2,5	-	1
68781	6,90	20	2,5	-	1
68782	8,80	24	3,0	-	1
68783	9,60	26	3,0	-	1
68784	10,50	28	3,0	-	1
68785	11,20	30	3,0	-	1
68786	12,10	32	3,0	-	1



### Molde pizza

Moule à pizza · Pizzablech  
Pizza mould · Molde pizza

Ref	€	Ø (cm)	h(cm)	U.Venta
68472	5,40	29,5	1,5	1
68473	6,30	34,0	2,0	1
68470	6,70	33,5	1,0	1
68471	8,60	36,0	1,0	1

### Bandeja

Plateaux · Tablett  
Tray · Bandeja

Ref	€	cm	h(cm)	U.Venta
68462	13,20	34x24	2,5	1
68463	14,30	39x26,5	3,0	1
68464	16,40	44x29	3,0	1



# Colección Noir



- Fabricado en acero al carbono.
- Revestimiento antiadherente de gran calidad sin PFOA en el interior y el exterior.
- Distribuye el calor de manera uniforme.
- Apto para hornos hasta 240°C.
- No se recomienda lavarlo en el lavavajillas.

- Fabriqué en acier au carbone.
- Revêtement anticartier de haute qualité sans PFOA à l'intérieur et à l'extérieur.
- Distribuez la chaleur uniformément.
- Apte pour les fours jusqu'à 240 ° C.
- Il n'est pas recommandé de le laver au lave-vaisselle.

- Manufactured in carbon steel.
- High quality antiating coating without PFOA inside and outside.
- Distribute heat evenly.
- Apt for furnaces up to 240 ° C.
- It is not recommended to wash it in the dishwasher.



## Molde 12 cavidades madalenas

Plaque madeleine 12 alveoles · Muffinform 12 Madeleine  
12 cups madelaine pan · Molde cavidades 12 madalenas

Ref	€	cm	h(cm)	U.Venta
68000	15,70	39,8x19,5	2,0	1



## Molde 12 cavidades

Plaque à biscuits 12 alveoles · Madeleine-Backform für 12 Madeleine  
12 cups muffin pan · Molde 12 cavidades

Ref	€	cm	h(cm)	U.Venta
68010	18,60	35x26,5	3,0	1



## Molde cake chapa antiadherente

Moule à cake tôle anti-adh. · Back/Pastetenform, Antihaf  
Cake mould rolled. · Molde cake chapa aderente

Ref	€	cm	h(cm)	U.Venta
68725	9,00	25x12	8,5	6
68730	9,20	30x12	8,5	6
68735	10,20	35x12	8,5	6



## Molde desmontable redondo

Moule rond desmontable · Tortenbodenform  
Dismountable round mould · M. desmontável redondo

Ref	€	Ø (cm)	h(cm)	U.Venta
68714	11,10	24	7	1
68716	11,60	26	7	1
68718	11,70	28	7	1



## Juego 4 cornetes

Ensemble de 4 moule cornet · Hornförmchen 4-tlg  
4 pcs. non stick cream horn set · Jogo 4 forma de cornucópia

Ref	€	cm	U.Venta
68936	6,90	12	6

# Moldes Bombón



- Molde profesional para elaborar deliciosos y originales bombones.
- Fabricado en poliestireno de alta calidad.
- Obtén bombones perfectos y con un brillo único.
- Cómodo de utilizar: rellena el molde con chocolate fundido, retira el exceso de chocolate deja reposar, vuelca el molde y da un pequeño golpe para que salgan los bombones.
- Fácil de limpiar y resistente al uso diario.
- Superficie lisa para un mejor desplazamiento de la espátula a la hora de retirar el chocolate sobrante.

- Moule professionnel pour faire des chocolats délicieux et originaux.
- Fabriqué en polystyrène de haute qualité.
- Obtenez des chocolats parfaits et avec un éclat unique.
- Confortable à utiliser: Remplissez le moule de chocolat fondu, retirez l'excès de chocolat, laissez reposer, tournez le moule et prenez un petit coup pour que les chocolats sortent.
- Facile à nettoyer et résistant à l'utilisation quotidienne.
- Surface lisse pour un meilleur déplacement de spatule lors de l'élimination des restes de chocolat.

- Professional mold to make delicious and original chocolates.
- Made of high quality polystyrene.
- Get perfect chocolates and with a unique shine.
- Comfortable to use: Fill the mold with molten chocolate, remove excess chocolate, let stand, turn the mold and take a small blow for the chocolates to come out.
- Easy to clean and resistant to daily use.
- Smooth surface for a better spatula displacement when removing leftover chocolate.

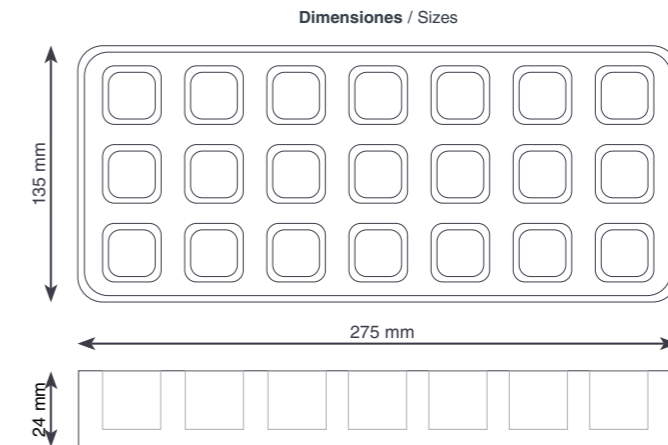

## Molde bombón

Moule pour chocolats · Pralinengießform  
Chocolate mould · Molde para bombons

	Ref	€	cm	h(cm)	Capacidad	U.Venta	
A	66870	17,90	Ø2,8	19,0	7 ml	1	Semiesférica · Half-sphere
B	66871	17,90	2,5x2,0	11,5	6 ml	1	Corazón · Heart
C	66872	17,90	2,5x2,5	17,0	10 ml	1	Lineal · Linear
D	66874	17,90	2,5x2,5	17,0	10 ml	1	Cuadrado · Square
E	66875	17,90	3,5x1,9	12,0	7 ml	1	Hoja · Eaf
F	66877	17,90	3,2x2,5	12,5	7 ml	1	Ondulado · Ondulated



# Aros repostería



- **Fabricado en acero inoxidable 18/10.**
- **Ideal para brisa, hojaldre y choux.**
- **Consigue bordes regulares, bien denidos y con una extracción perfecta de la base. Acabado excepcional.**
- **Disponible en distintas formas y tamaños.**

- **Fabriqué en acier inoxydable 18/10.**
- **Idéal pour la brise, la pâte feuilletée et le choux.**
- **Obtenez des bords réguliers, bien appelés et avec une extraction parfaite de la base. Finition exceptionnelle.**
- **Disponible en différentes formes et tailles.**

- **Made of stainless steel 18/10.**
- **Ideal for breeze, puff pastry and choux.**
- **Get regular edges, well called and with a perfect extraction of the base. Exceptional finish.**
- **Available in different shapes and sizes.**



**Aro redondo**  
Cercle rond · Kuchen-/Ausstechformen, rund  
Round cake ring · Aro redondo

**Aro redondo Mouse**  
Cercle rond · Kuchen-/Ausstechformen, rund  
Round cake ring · Aro redondo

**Aro redondo Vacherin**  
Cercle rond · Kuchen-/Ausstechformen, rund  
Round cake ring · Aro redondo

Ref	€	Ø (cm)	h(cm)	U.Venta
68406	3,10	6	4	12
68407	3,20	7,5	4	12
68408	3,30	8	4	12
68410	3,40	10	4	12
68412	5,30	12	4	12
68414	5,00	14	4	6
68416	6,90	16	4	6
68418	8,20	18	4	6
68420	10,00	20	4	1
68422	10,10	22	4	1
68424	11,40	24	4	1

Ref	€	Ø (cm)	h(cm)	U.Venta
68506	3,10	6	4,5	12
68508	3,20	8	4,5	12
68509	3,30	9	4,5	12
68510	3,40	10	4,5	12
68512	4,30	12	4,5	12
68514	5,00	14	4,5	12
68516	7,00	16	4,5	6
68518	8,10	18	4,5	6
68520	8,80	20	4,5	6
68522	10,30	22	4,5	1
68524	10,70	24	4,5	1
68526	11,80	26	4,5	1

Ref	€	Ø (cm)	h(cm)	U.Venta
68607	4,30	7	6	12
68608	4,40	8	6	12
68609	4,50	9	6	12
68610	4,70	10	6	12
68612	6,30	12	6	6
68614	7,30	14	6	6
68616	10,00	16	6	6
68618	11,20	18	6	1
68620	14,50	20	6	1
68622	15,40	22	6	1
68624	16,60	24	6	1
68626	17,80	26	6	1
68628	19,40	28	6	1



**Aro redondo Entremet**  
Cercle rond · Kuchen-/Ausstechformen, rund  
Round cake ring · Aro redondo

Ref	€	Ø (cm)	h(cm)	U.Venta
68308	3,20	8	3,5	12
68310	3,20	10	3,5	12

INOX 18/10

**Molde cuadrado**  
Carre pour patisserie · Kuchen-/Ausstech formen, vierecking  
Square pastry mould · Molde cuadrado

Ref	€	cm	h(cm)	U.Venta
68460	4,80	6x6	4	12
68480	4,90	8x8	4	12
68411	5,00	10x10	4	12
68441	5,30	14x14	4	6
68240	6,80	20x20	4	6



**Juego aros repostería**  
Ensemble de cercles à pâtisserie · Ausstechformen, Set  
Pastry rings set · Jogo aros de pasteleria

Ref	€	cm	h(cm)	Forma	U.Venta
68203	11,10	Ø7,7	null	Redondo · Round	1



INOX 18/10

**Aro tarta borde vuelto**  
Cercle "goutte" · Tortenring  
Tart ring · Aro torta

Ref	€	Ø (cm)	h(cm)	U.Venta
68107	3,70	8	2,2	6
68121	3,90	10	2,2	6
68120	7,80	20	2,2	1



INOX 18/10



INOX 18/10

**Aro repostería extensible**  
Cercle extensible · Kuchenform, verstellbar  
Adjustable pastry ring · Aro extensivel pasteleria

Ref	€	Ø (cm)	h(cm)	U.Venta
68200	18,20	16-30	7,0	1

**Aro cuadrado perforado**  
Cercle carre perforee · Kuchen-/Ausstechformen, gelocht  
Perforated square cake ring · Aro cuadrado perforada

Ref	€	cm	h(cm)	U.Venta
68557	3,80	7x7	2,0	6
68556	6,30	16x16	2,0	6
68560	7,80	20x20	2,0	6
68567	5,10	7x7	3,5	6
68566	9,90	16x16	3,5	6
68570	12,00	20x20	3,5	6

**Aro rectangular perforado**  
Cercle rectangulaire perforee · Kuchen-/Ausstechformen, gelocht  
Perf. rectangular cake ring · Aro rectangular perf.

Ref	€	cm	h(cm)	U.Venta
68590	5,30	7x20	2,0	6
68591	8,10	7x20	3,5	6
68597	10,70	8x28	3,5	6
68598	6,60	8x28	2,0	6



INOX 18/10

**Aro redondo perforado**  
Cercle rond perforee · Kuchen-/Ausstechformen, rund, gelocht  
Perforated round cake ring · Aro redondo perforada

Ref	€	Ø (cm)	h(cm)	U.Venta
68537	3,20	7	2,0	6
68532	4,00	12	2,0	6
68536	5,10	16	2,0	6
68538	5,60	18	2,0	6
68540	6,50	20	2,0	6
68544	7,80	24	2,0	6
68558	8,70	28	2,0	6
68547	4,40	7	3,5	6
68552	6,50	12	3,5	6
68546	7,90	16	3,5	6
68548	8,80	18	3,5	6
68550	9,90	20	3,5	6
68554	11,80	24	3,5	6
68568	13,90	28	3,5	6

INOX 18/10

**Aro oval perforado**  
Cercle oval perforee · Kuchen-/Ausstechformen, oval, gelocht  
Perforated oval cake ring · Aro oval perforada

Ref	€	cm	h(cm)	U.Venta
68580	5,10	7x20	2,0	6
68581	7,40	7x20	3,5	6
68588	6,50	8x28	2,0	6
68587	10,20	8x28	3,5	6



INOX 18/10

**Aro corazón perforado**  
Cercle coeur perforee · Kuchen-/Ausstechformen, gelocht  
Perforated heart ring · Aro coração perforada

Ref	€	Ø (cm)	h(cm)	U.Venta
68482	4,60	12	2,0	6
68488	3,10	8	2,0	6



INOX 18/10

**Aro hoja perforado**  
Cercle feullere perforee · Kuchen-/Ausstechformen, gelocht  
Perforated Eal ring · Aro folha perforada

Ref	€	cm	h(cm)	U.Venta
68492	3,50	12x5	2,0	6
68498	4,50	18x7,8	2,0	6





## Pizarras Menú

Personalizable en tiza o rotuladores fluorescentes (Ref.: 39161).  
Fácil de limpiar.  
Can be personalised with chalk or fluorescent markers (Ref.: 39161).  
Easy to clean.



RUBBER  
WOOD

- Diseño tradicional. Ofrece un espacio para que los establecimientos de hostelería expongan en sus locales como en la calle sus productos y menús.
- Puede ser personalizada tanto con tizas como con rotuladores.
- Limpieza muy sencilla con un simple trapo húmedo.

- Conception traditionnelle. Il offre un espace pour les établissements hôteliers pour exposer leurs produits et menus dans la rue.
- Il peut être personnalisé avec la craie et les marqueurs.
- Nettoyage très simple avec un simple chiffon humide.

- Traditional design. It offers a space for hospitality establishments to exhibit their products and menus in the street.
- It can be customized with both chalk and markers.
- Very simple cleaning with a simple wet cloth.



Diseñada para ser colocada en la pared.  
Designed to be fixed on the wall.

### Pizarra menú Doble

Menu ardoise · Schreibrtafel Menu  
Menu blackboard · Quadro de menu

Ref	€	cm	AxB (cm)	U.Venta
39166	94,80	55x85	47x67	1
39164	137,70	65x115	55x90	1

### Pizarra menú

Menu ardoise · Schreibrtafel Menu  
Menu blackboard · Quadro de menu

Ref	€	cm	AxB (cm)	U.Venta
A 39162	52,30	50x80	43x73	1
B 39163	57,20	50x80	43x73	1

NO incluidos  
NOT included

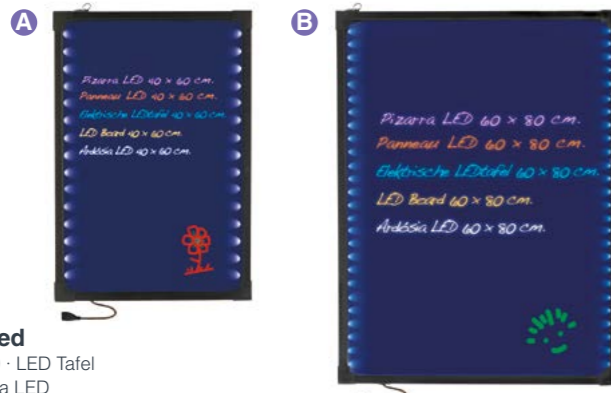

### Pizarra eléctrica Led

Tableau lumineux à LED · LED Tafel  
Blackboard LED · Ardósia LED

Ref	€	W	Funciones	Medidas	U.Venta
A 39140	105,50	2	38	40x60 cm	1
B 39160	144,80	2	38	60x80 cm	1

- Para usar con la pizarra eléctrica led (ref. 39140-60).
- No son tóxicos. Fáciles de limpiar.

- To use with the LED electric board (Ref. 39140-60).
- They are not toxic. Easy to clean.



### Rotuladores fluorescentes

Marqueurs fluorescents · Fluoreszierenden marker  
Fluorescent markers · Maracadores fluorescentes

Ref	€	cm	U.Venta
39161	34,10	10	1

## Porta menú Acrílico - Aluminio

ASA  
Acrylic



**Pared:** gracias a los accesorios incluidos para anclar en la pared  
**Sobremesa:** gracias a los pies de apoyo incluidos  
**Intercambiable de forma fácil, rápida y cómoda**  
Wall: thanks to the included accessories to anchor on the wall  
Table: thanks to the support feet included  
An easy, quick and convenient exchangeable

### Porta Menú Acrílico

Porte-menu · Menü-Ständer  
Menu holder · Porta-menus

Ref	€	cm	U.Venta
A 39403	74,40	50x38 (A3)	1
B 39404	57,20	29x38 (A4)	1



ASA AL  
Acrylic Aluminium

### Atril + portamenú acrílico

Pupitre porte-menu · Menü-Ständer  
Menu holder lectern · Atril porta-menus

Ref	€	cm	Tamaño	U.Venta
A 39402	148,90	34x30x103	-	1
B 39423	223,20	34x30x107	A3	1
C 39424	206,00	34x30x107	A4	1



AL  
Aluminium

### Portamenú Aluminio

Porte-menu · Menü-Ständer  
Menu holder · Porta-menus

Ref	€	cm	U.Venta
A 39413	40,20	46x34 (A3)	1
B 39414	28,70	25,5x34 (A4)	1



AL  
Aluminium

### Atril + Porta menú aluminio

Pupitre porte-menu · Menü-Ständer  
Menu holder lectern · Atril porta-menus

Ref	€	cm	Tamaño	U.Venta
A 39402	148,90	34x30x103	-	1
B 39433	188,90	34x30x107	A3	1
C 39434	177,40	34x30x107	A4	1



# Porta menú sobremesa

- Ideales para resaltar todo tipo de información (menú, especialidades del día, promociones, etc.).
- Desmontables para escribir fácilmente.
- Fácil limpieza.

- Idéales pour faire ressortir tout type d'information (Menu, spécialités du jour, promotions, etc.).
- Démontables pour écrire confortablement.
- Nettoyage facile.

- Perfect for displaying all kinds of information (Fixed price menu, daily specials, promotions, etc.).
- Can be taken apart for easier writing.
- Easy to clean.

Fijación mediante imán  
Magnetic fixing

Visualización a doble cara  
Double-sided display

ASA  
Acrylic

Base desmontable  
Removable base



Apta para rotuladores fluorescentes (Ref.: 39161)  
Can be used with fluorescent markers (Ref.: 39161)

Soporte de madera de pino con acabado caoba  
Walnut coloured Pinewood support



## Porta menú Acrylic

Porte-menu de table · Desktop-Menu  
Menu cover · Porta menu de mesa

Ref	€	cm	U.Venta
39405	10,60	11x17	1
39406	11,60	13x19	1
39407	25,10	21x30	1

## Porta menú Pizarra

Porte-menu de table · Desktop-Menu  
Menu cover · Porta menu de mesa

Ref	€	cm	U.Venta
39415	15,50	10x15	1
39420	18,40	15x20	1
39430	22,70	20x30	1

Soporte de madera de pino con acabado caoba  
Walnut coloured Pinewood support

## Porta menú pinza

Porte-menu de table · Desktop-Menu  
Menu cover · Porta menu de mesa

Ref	€	cm	U.Venta
39410	23,30	18x23	1
39411	7,20	-	1



Pinza · Clamp

# Porta menú

Materiales certificados · Matériaux certifiés · Authorised materials

## Cuero reciclado · Recycled leather

- Fabricado en cuero 100% reciclado (80% de cuero y un 20% de caucho natural). Espesor de 1,6 mm.
- Certificado OEKO-TEX®.
- Producidos artesanalmente en España.
- Máxima calidad; duraderos y resistentes.
- Fácil de limpiar (no utilizar jabones abrasivos).

- Fabriqué en cuir recyclé à 100 % (80 % de cuir et 20 % de caoutchouc naturel). Épaisseur de 1,6 mm.
- Certifié OEKO-TEX®.
- Fabriqué à la main en Espagne.
- Qualité maximale ; durable et résistant.
- Facile à nettoyer (ne pas utiliser de savons abrasifs).

- Made of 100% recycled leather (80% leather and 20% natural rubber). Thickness of 1.6 mm.
- OEKO-TEX® certified.
- Handcrafted in Spain.
- Maximum quality; durable and resistant.
- Easy to clean (do not use abrasive soaps).

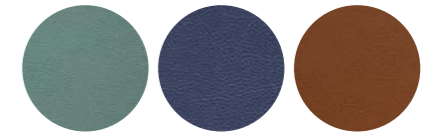

## Fibra de celulosa · Cellulose fibre

- Fabricado en 100% fibra de celulosa. Material 100% vegano. Certificado OEKO-TEX®.
- Producidos artesanalmente en España.
- Tacto similar al cuero, blando y flexible. Diseño elegante y sostenible.
- Lavable con agua tibia y jabón neutro (no utilizar jabones abrasivos).

- Fabriqué en fibre de cellulose à 100 %. Matériau 100 % végétalien. Certifié OEKO-TEX®.
- Fabriqué à la main en Espagne.
- Sensation de cuir, souple et flexible. Design élégant et durable.
- Lavable à l'eau chaude et au savon neutre (ne pas utiliser de savon abrasif).

- Made of 100% cellulose fibre. 100% vegan material. OEKO-TEX® certified.
- Handmade in Spain.
- Leather-like feel, soft and flexible. Elegant and sustainable design.
- Washable with warm water and neutral soap (do not use abrasive soaps).

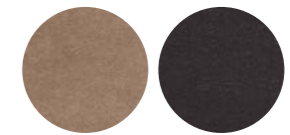

## Teflex

- Fabricado por un soporte celulósico recubierto con una capa vinílica de alta resistencia.
- Producidos artesanalmente en España.
- Acabado imitación tela. Gran flexibilidad y durabilidad.
- Resistencia a la abrasión, manchado y rayado. Fácil de limpiar (no utilizar jabones abrasivos).

- Fabriqué à partir d'un support en cellulose recouvert d'un revêtement en vinyle très résistant.
- Fabriqué à la main en Espagne.
- Finition imitation tissu. Grande flexibilité et durabilité.
- Résistant à l'abrasion, aux taches et aux rayures. Facile à nettoyer (ne pas utiliser de savons abrasifs).

- Made of a cellulose backing covered with a highly resistant vinyl coating.
- Handmade in Spain.
- Imitation fabric finish. High flexibility and durability.
- Resistant to abrasion, stains and scratches. Easy to clean (do not use abrasive soaps).

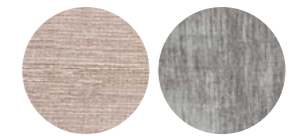

## Simil-Piel

- Fabricado en poliuretano de gran calidad.
- Producidos artesanalmente en España.
- Base de tejido suave y ligeramente extensible. Aspecto de piel y tacto único.
- Material termo-irradiado; permite conseguir un atractivo efecto de estampado.
- Fácil de limpiar (no utilizar jabones abrasivos).

- Fabriqué en polyuréthane de haute qualité.
- Fabriqué à la main en Espagne. Base en tissu souple et légèrement extensible.
- Aspect et toucher cuir uniques.
- Matériau thermo-virable ; permet d'obtenir un effet de motif attrayant.
- Facile à nettoyer (ne pas utiliser de savons abrasifs).

- Made of high quality polyurethane.
- Handmade in Spain.
- Soft and slightly stretchable fabric base. Unique leather look and feel.
- Thermo-irradiable material; allows for an attractive patterned effect.
- Easy to clean (do not use abrasive soaps).

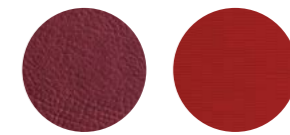
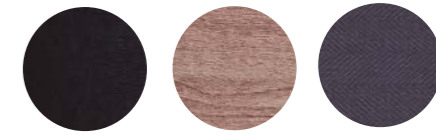
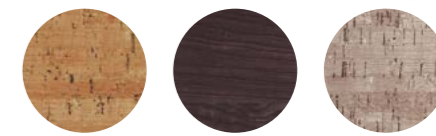



### Fundas fijas

Protège-feuilles · Fixed flaps

**Fundas fijas de PVC en piel de naranja. Altamente resistentes.**  
Protège-feuilles fixes en PVC en peau d'orange. Hautement résistantes.  
Highly resistant, fixed frosted PVC covers.

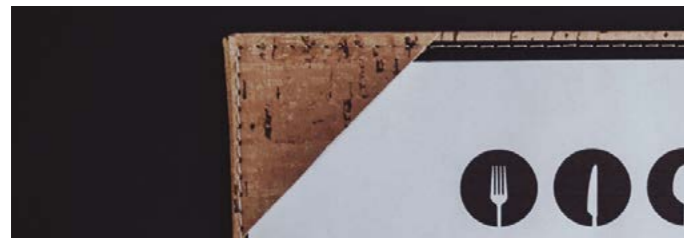

### Solapas fijas

Rabats fixes · Fixed flaps

**Solapas fijas a la cubierta**  
Rabats fixes sur la couverture  
Flaps fixed to the cover



### Cordón de cuero

Cordon en cuir · Leather cord

**Permite añadir o cambiar fundas.**  
Permet d'ajouter ou de modifier des pochettes.  
New covers can be added.

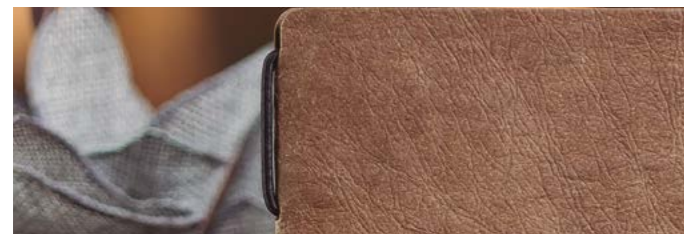

### Goma

Élastique · Elastic band

**Permite añadir o cambiar fundas.**  
Permet d'ajouter ou de modifier des pochettes.  
New covers can be added.

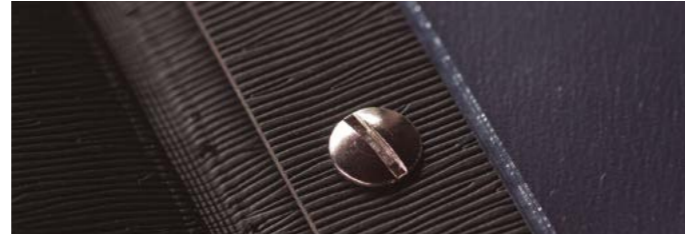

### Atornillado interior

Vissage intérieur · Interior screwed

**Permite añadir o cambiar fundas.**  
Permet d'ajouter ou de modifier des pochettes.  
New covers can be added.



### Atornillado exterior

Vissage extérieur · Exterior screwed

**Permite añadir o cambiar fundas.**  
Permet d'ajouter ou de modifier des pochettes.  
New covers can be added.

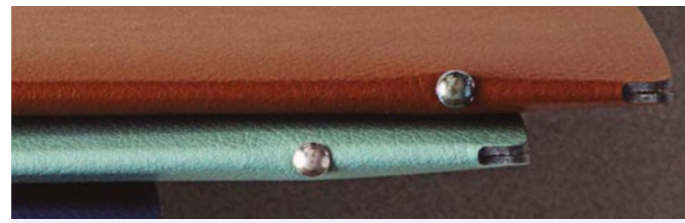

### Remache lateral

Rivet latérale · Remache lateral

**Permite añadir o cambiar fundas.**  
Permet d'ajouter ou de modifier des pochettes.  
New covers can be added.



### Pinza

Pince · Clip

**Pinza metálica de color plata que sujeta la hoja del menú**  
Doté d'une pince métallique couleur argent qui tient la feuille de menu  
Silver-coloured metal clip that holds the menu in place

PVC  
Plastic

### Set 10 fundas interiores PVC

Jeu 10 feuilles intérieures PVC Peau d'orange · 10 Tlg. Innere Blätter, PVC, Orangenhaut  
Set 10 interior frosted PVC pages · Set 10 lâminas interiores de PVC pele de Laranja

Ref	€	cm	U.Venta	Compatible con · Compatible with
28191	12,00	21x29,7 (A4)	10	Ref.: 28261, 28500, 28510, 28520, 28530
28192	9,30	14x26	10	Ref.: 28511, 28531, 28521, 28501, 28212, 28262
28190	8,30	16x29,7	10	Ref.: 28342, 28352, 28372
28193	9,40	14,8x21 (A5)	10	Ref.: 28512, 28343, 28532, 28353, 28522, 28373, 28502, 28213, 28263
28194	12,00	21x29,7 (A4)	10	Ref.: 28550, 28540, 28371, 28351
28203	12,00	25x32 (A4)	10	Ref.: 28211, 28231, 28341, 28341, 28391
28451	12,20	23x31	10	Ref.: 28411, 28431 (doble-doble)
28452	10,60	17x32	10	Ref.: 28412, 28432 (doble-doble)
28453	7,50	16,5x23,5	10	Ref.: 28413, 28433 (doble-doble)
66890	12,20	22x31 (A4)	10	Ref.: 66858, 66860, 66859 (doble-doble)
66891	10,50	16,5x31	10	Ref.: 66861, 66863, 66862 (doble-doble)
66892	7,50	16x22 (A5)	10	Ref.: 66864, 66866, 66865 (doble-doble)



### Set 12 cantoneras

Jeu 12 coins · 12 Tlg. Kantenschutz  
Set 12 angle irons · Set 12 cantoneiras

Ref	€	Color	U.Venta
28195	5,20	Negro · Black	1
28197	5,20	Oro · Gold	1
28198	5,20	Plata · Silver	1



### Set 12 tornillos rosca

Jeu 12 vis · 12 Tlg. Schrauben  
Set 12 screws · Set 12 parafusos

Ref	€	Color	U.Venta
28196	10,90	Plata · Silver	1
28199	11,20	Negro · Black	1

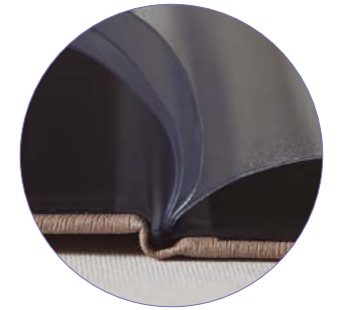

### Set 12 cordones de cuero

Jeu 12 cordons en cuir · 12 Tlg. Lederschnur  
Set 12 leather laces · Set 12 cordões de couro

Ref	€	m	Color	U.Venta
28200	1,50	1	Marrón · Brown	12

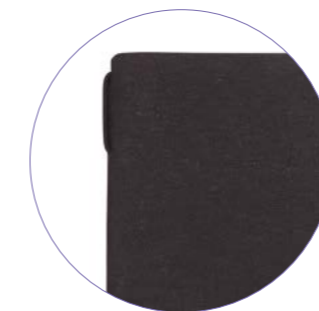

### Set 10 gomas

Jeu 10 élastiques · 10 Tlg. Gummis  
Set 10 elastic bands · Set 10 elásticos

Ref	€	Color	U.Venta	Compatible
28205	7,40	Negro · Black	1	Ref: 28411, 28412, 28432
28206	7,40	Negro · Black	1	Ref: 28413, 28433



### Set 12 tornillos laterales

Jeu 12 cordons en cuir · 12 Tlg. Lederschnur  
Set 12 leather laces · Set 12 cordões de couro

Ref	€	Color	U.Venta
66867	8,20	Gold	1
66868	8,20	Silver	1





✓ **Destaca tu marca y personaliza a medida cualquiera de nuestros productos.**

Mettez votre marque en valeur et personnalisez l'un de nos produits.  
Highlight your brand and customise any of our products.

✓ **Te ayudamos a diseñar y fabricar tu propio proyecto. ¡Cuéntanos tu idea!**

Nous vous aidons à concevoir et à fabriquer votre propre projet, faites-nous part de votre idée !  
We help you to design and manufacture your own project, tell us your idea!

✓ **Estampación en relieve: Disponemos de una amplia variedad de colores, tamaños, etc. para diseñar un producto único.**

Estampage en relief : Nous disposons d'une grande variété de couleurs, de tailles, etc. pour concevoir un produit unique.  
Embossed stamping: We have a wide variety of colours, sizes, etc. to design a unique product.

## ¿Cómo? Comment? How?



1

**Envíanos tu archivo vectorizado ( formato .ai)**

Envoyez-nous votre fichier vectorisé (format .ai)  
Send us your vectorised file (.ai format)

¿No dispones de ello? Vous ne l'avez pas ? Don't you have it?



**Nosotros te lo diseñamos (Coste 20€)**

Nous le concevons pour vous (Coût 20€)  
We design it for you (Cost 20€)



2

**Selecciona la posición** · Sélectionner la position · Select the position



3

**Selecciona el color** · Sélectionner la couleur · Select colour

✓ **Cantidad mínima para personalización a partir de 15 unidades**

Quantité minimale pour la personnalisation à partir de 15 unités  
Minimum quantity for personalisation from 15 units onwards

✓ **Precio por personalización del sello: 46€**

Prix pour la personnalisation du timbre : 46€  
Price for stamp personalisation: 46€

✓ **El plazo de entrega para los portamenús personalizados es de 15 días naturales**

Le délai de livraison des porte-menus personnalisés est de 15 jours calendaires  
The delivery period for the personal portamenús is 15 calendar days

A



B



C



D



**Color** · Couleur · Colour

**En seco (sin color)** · Dry (without colour)

**Blanco** · White

**Negro** · Black

**Rojo** · Red

**Oro** · Gold

**Azul** · Blue

**Plata** · Silver

**Crema** · Cream

**Marrón** · Brown

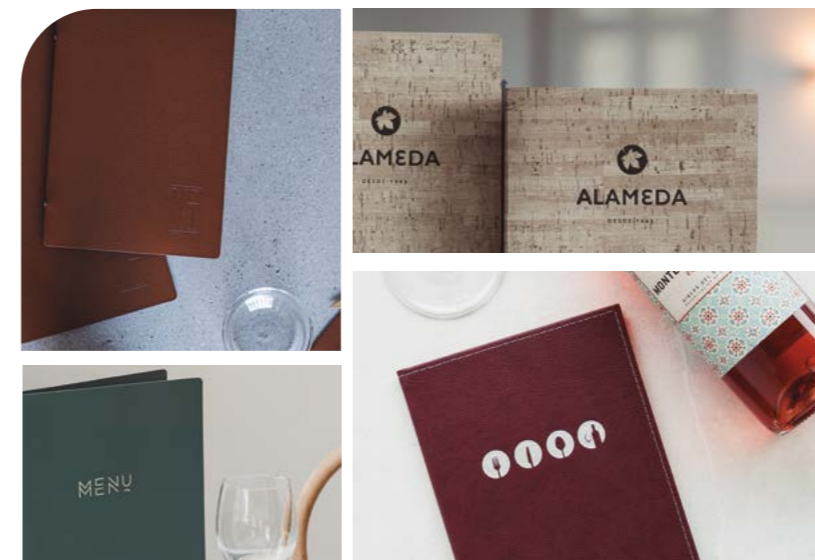

**Nota · Note:**

★ **No se recomienda la estampación en seco en las siguientes colecciones:**

Dry printing is not recommended in the following collections:

Lisa · Velázquez · Helen · Tomasso · André · Matisse · Charlotte · Degas · Cassat · Edgar · Sophie · Paul · Goya · Marcel · Andy · Natutal · Tex

★ **Material Simil-Piel material:**

Se recomienda personalizar en color blanco, azul, negro, rojo o marrón.  
It is recommended to customize in white, blue, black, red or brown colour.

## ¿Otra idea?

Une autre idée ? · Another idea?



**100% personalizables; forma, tamaño, etc.**

100% personnalisable ; forme, taille, etc.  
100% customisable; shape, size, etc.

## ¿Alguna duda? ¡Consúltenos!

Avez-vous des doutes ? Demandez-nous !  
Do you have any doubts? Please ask us!



**Comercial@lacor.es**  
export@lacor.es



**Nacional: +34 943 76 90 30**  
Export: +34 943 76 91 74



Recycled leather

new

- Fabricado en cuero 100% reciclado ( 80% de cuero y un 20% de caucho natural).
- Certificado OEKO-TEX®.
- Producido artesanalmente en España.
- Máxima calidad; duraderos y resistentes.
- Espesor de 1,6 mm.
- Fácil de limpiar (no utilizar jabones abrasivos). Incluye 4 fundas dobles (8 caras).
- 100% personalizables: diseñamos y customizamos a tu gusto.

- Fabriqué en cuir recyclé à 100 % (80 % de cuir et 20 % de caoutchouc naturel).
- Certificat OEKO-TEX®.
- Fabriqué à la main en Espagne.
- Qualité supérieure ; durable et résistant.
- Épaisseur de 1,6 mm.
- Facile à nettoyer (ne pas utiliser de savons abrasifs).
- 4 intercalaires (8 vues).
- 100% personnalisable : nous concevons et personnalisons selon vos goûts.

- Made of 100% recycled leather (80% leather and 20% natural rubber).
- OEKO-TEX® certified.
- Handcrafted in Spain.
- Maximum quality; durable and resistant.
- Thickness of 1.6 mm.
- Easy to clean (do not use abrasive soaps).
- Include 4 double covers (8 sides).
- 100% customisable: we design and customise to your taste.

## SAURA

**MATERIAL:** Cuero reciclado · Recycled leather

**SELLO · SEAL:** Termosellado en color crema · Heat-sealed in cream colour

**FIJACIÓN · FIXINGS:** Remache lateral. Color oro · Side rivet. Gold colour



Blando - Soft

### Porta menú Saura

Porte-menu · Speisekartenmappe  
Menu cover · Porta-menu

	Ref	€	cm	Fundas	U.Venta
<b>A</b>	66858	24,80	32x23(A4)	4	4
<b>B</b>	66861	21,20	32x17,5	4	4
<b>C</b>	66864	19,10	23,5x17(A5)	4	4



## SIMONE

**MATERIAL:** Cuero reciclado · Recycled leather

**SELLO · SEAL:** Termosellado en seco · Dry heat-sealed

**FIJACIÓN · FIXINGS:** Remache lateral. Color oro · Side rivet. Gold colour



Blando - Soft

### Porta menú Simone

Porte-menu · Speisekartenmappe  
Menu cover · Porta-menu

	Ref	€	cm	Fundas	U.Venta
<b>A</b>	66860	24,80	32X23(A4)	4	4
<b>B</b>	66863	21,20	32x17,5	4	4
<b>C</b>	66866	19,10	23,5x17 (A5)	4	4



## BOSCO

**MATERIAL:** Cuero reciclado · Recycled leather

**SELLO · SEAL:** Termosellado en color gris · Heat-sealed in grey colour

**FIJACIÓN · FIXINGS:** Remache lateral. Color plata · Side rivet. Silver colour



Blando - Soft

### Porta menú Bosco

Porte-menu · Speisekartenmappe  
Menu cover · Porta-menu

	Ref	€	cm	Fundas	U.Venta
<b>A</b>	66859	24,80	32x23 (A4)	4	4
<b>B</b>	66862	21,20	32x17,5	4	4
<b>C</b>	66865	19,10	23,5x17 (A5)	4	4



### Porta facturas Bosco

Porte-factures · Halter für Rechnungen  
Ticket holder · Porta facturas

	Ref	€	cm	U.Venta
	66848	18,10	11x18,5	4

# NATURAL



**MATERIAL:** Fibra de celulosa · Celulose fibre

**SELLO · SEAL:** Termosellado en color negro · Heat-sealed in black colour

**FIJACIÓN · FIXINGS:** Sujeción con goma · Closes with elastic band



Blando - Soft

## Porta menú Natural

Porte-menu · Speisekartenmappe

Menu cover · Porta menu

	Ref	€	cm	Fundas	U.Venta
<b>A</b>	28411	21,40	23x32 (A4)	4	4
<b>B</b>	28412	19,70	17x32	6	4
<b>C</b>	28413	17,50	16,5x23,5 (A5)	6	4



# TEX



**MATERIAL:** Fibra de celulosa · Celulose fibre

**SELLO · SEAL:** Termosellado en color negro · Heat-sealed in black colour

**FIJACIÓN · FIXINGS:** Sujeción con goma · Closes with elastic band



Blando - Soft

## Porta menú Tex

Porte-menu · Speisekartenmappe

Menu cover · Porta menu

	Ref	€	cm	Fundas	U.Venta
<b>A</b>	28431	21,40	23x32 (A4)	4	4
<b>B</b>	28432	19,70	17x32	6	4
<b>C</b>	28433	17,50	16,5x23,5 (A5)	6	4



# HELEN



**MATERIAL:** Simil - Piel

**SELLO · SEAL:** Termosellado en color marrón · Heat-sealed in brown colour

**FIJACIÓN · FIXINGS:** Cordón de cuero · Leather cord

## Porta menú Helen

Porte-menu · Speisekartenmappe

Menu cover · Porta menu

	Ref	€	cm	Fundas	U.Venta
<b>A</b>	28341	26,20	25,5x32 (A4)	3	4
<b>B</b>	28342	21,50	19,5 x 32	3	4
<b>C</b>	28343	20,20	19x23,5 (A5)	3	4

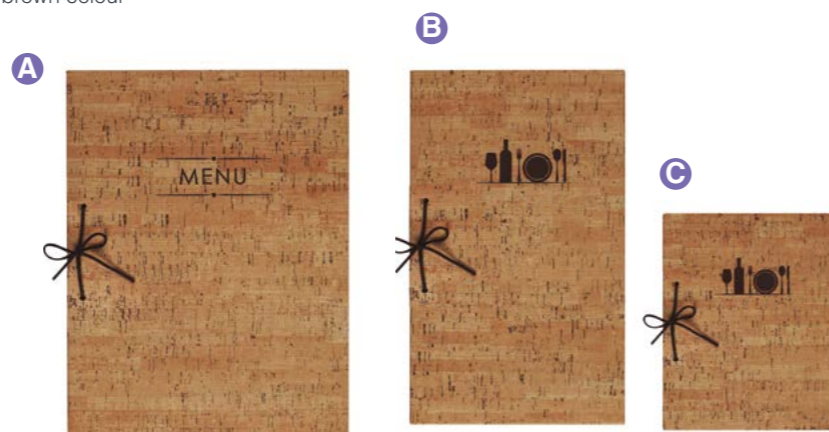

# VELÁZQUEZ



**MATERIAL:** Simil - Piel

**SELLO · SEAL:** Termosellado en color marrón · Heat-sealed in brown colour

**FIJACIÓN · FIXINGS:** Fundas fija · Fixed covers

## Porta menú Velázquez

Porte-menu · Speisekartenmappe

Menu cover · Porta menu

	Ref	€	cm	Fundas	U.Venta
<b>A</b>	28331	25,10	23x32 (A4)	4	4
<b>B</b>	28332	20,00	16x28,5	4	4
<b>C</b>	28333	19,10	17x23,5 (A5)	4	4

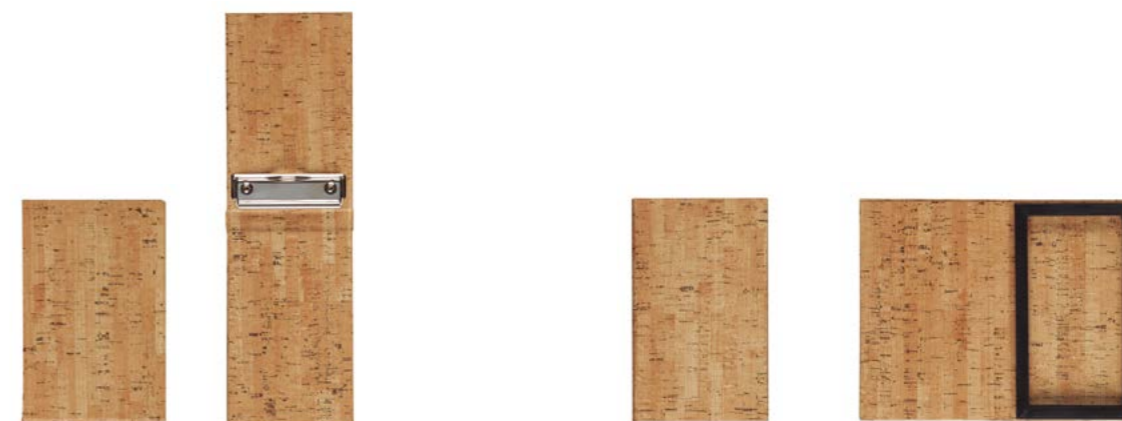
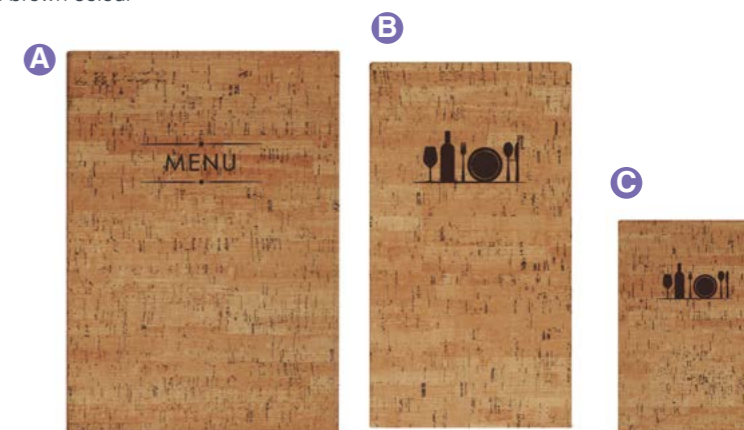

## Portacomandas Velázquez

Porte-commandes · Halter für Bestellungen

Order holder · Porta comandas

Ref	€	cm	U.Venta
28175	12,30	11x17,5	4

## Portafacturas Velázquez

Porte-factures · Halter für Rechnungen

Ticket holder · Porta facturas

Ref	€	cm	U.Venta
28176	19,70	11x18,5	4

# LISA



**MATERIAL:** Simil - Piel

**SELLO · SEAL:** Termosellado en color marrón · Heat-sealed in brown colour

**FIJACIÓN · FIXINGS:** Solapas fijas · Fixed flaps

## Portamenú Lisa

Porte-menu · Speisekartenmappe

Menu cover · Porta menu

Ref	€	cm	U.Venta
28177	22,90	23 x 32 (A4)	4



# SANDRO



**MATERIAL:** Teflex

**SELLO · SEAL:** Termosellado en color azul · Heat-sealed in blue colour

**FIJACIÓN · FIXINGS:** Atornillado exterior · Exterior screwed

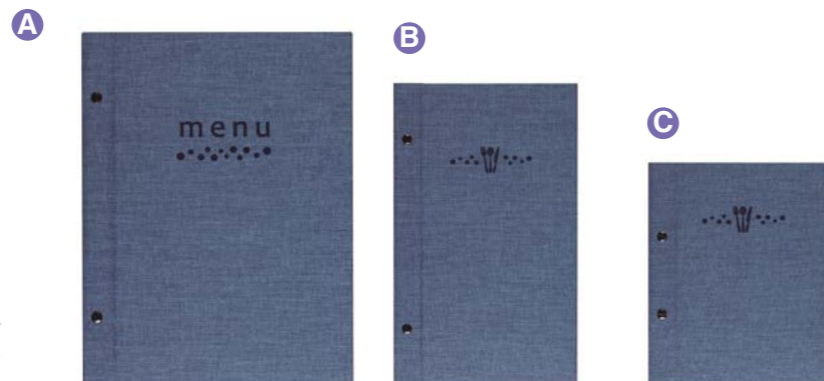

## Porta menú Sandro

Porte-menu · Speisekartenmappe  
Menu cover · Porta menu

	Ref	€	cm	Fundas	U.Venta
A	28371	25,40	25,5x32 (A4)	3	4
B	28372	20,80	19,5x32	3	4
C	28373	19,40	19x23,5 (A5)	3	4



## Portacomandas Sandro

Porte-commandes · Halter für Bestellungen  
Order holder · Porta comandas

	Ref	€	cm	U.Venta
	28375	11,90	11x17,5	4

## Portafacturas Sandro

Porte-factures · Halter für Rechnungen  
Ticket holder · Porta facturas

	Ref	€	cm	U.Venta
	28376	19,00	11x18,5	4

# RENÉ



**MATERIAL:** Simil-Piel

**SELLO · SEAL:** Termosellado en color crema · Heat-sealed in cream colour

**FIJACIÓN · FIXINGS:** Fundas fijas · Fixed covers



## Porta menú René

Porte-menu · Speisekartenmappe  
Menu cover · Porta menu

	Ref	€	cm	Fundas	U.Venta
A	28021	25,10	23x32 (A4)	4	4
B	28022	19,10	16x28,5	4	4
C	28023	20,00	17x23,5 (A5)	4	4

# NICOLÁS



**MATERIAL:** Simil-Piel

**SELLO · SEAL:** Termosellado en color crema · Heat-sealed in cream colour

**FIJACIÓN · FIXINGS:** Atornillado interior · Interior screwed



Blando - Soft

## Porta menú Nicolás

Porte-menu · Speisekartenmappe  
Menu cover · Porta menu

	Ref	€	cm	Fundas	U.Venta
A	28510	38,70	25,5x32 (A4)	3	4
B	28511	33,00	18x28,5	3	4
C	28512	33,60	19x23,5 (A5)	3	4



# ANDRÉ



**MATERIAL:** Teflex

**SELLO · SEAL:** Termosellado en color crema · Heat-sealed in cream colour

**FIJACIÓN · FIXINGS:** Sujeción fija · Fixed covers

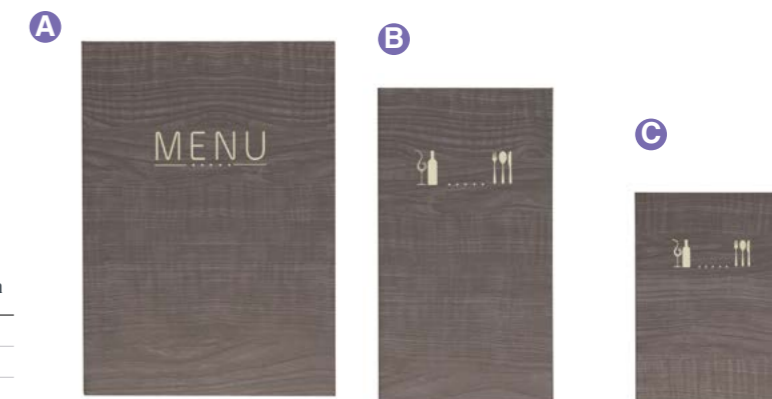

## Porta menú André

Porte-menu · Speisekartenmappe  
Menu cover · Porta menu

	Ref	€	cm	Fundas	U.Venta
A	28031	21,80	23x32 (A4)	4	4
B	28032	16,30	16x28,5	4	4
C	28033	17,00	17x23,5 (A5)	4	4

# CÉZANNE



**MATERIAL:** Simil-Piel

**SELLO · SEAL:** Termosellado en color crema · Heat-sealed in cream colour

**FIJACIÓN · FIXINGS:** Solapas · Fixed flaps



## Porta menú Cézanne

Porte-menu · Speisekartenmappe  
Menu cover · Porta menu

	Ref	€	cm	U.Venta
	28041	20,80	23x32 (A4)	4

# LEO



**MATERIAL:** Simil-Piel  
**SELLO · SEAL:** Termosellado en color crema · Heat-sealed in cream colour  
**FIJACIÓN · FIXINGS:** 3 solapas fijas · 3 fixed flaps

**Porta menú Leo**  
 Porte-menu · Speisekartenmappe  
 Menu cover · Porta menu

Ref	€	cm	Solapas	U.Venta
28151	30,30	23x32 (A4)	3	4



# TIZIANO



**MATERIAL:** Simil-Piel  
**SELLO · SEAL:** Termosellado en color crema · Heat-sealed in cream colour  
**FIJACIÓN · FIXINGS:** 3 solapas fijas · 3 fixed flaps

**Porta menú Tiziano**  
 Porte-menu · Speisekartenmappe  
 Menu cover · Porta menu

Ref	€	cm	Solapas	U.Venta
28172	27,70	17x24 (A5)	3	4



# CLAUDIO



**MATERIAL:** Simil-Piel  
**FIJACIÓN · FIXINGS:** Pinza metálica · Metal clip

**Porta menú Claudio**  
 Porte-menu · Speisekartenmappe  
 Menu cover · Porta menu

Ref	€	cm	U.Venta
28321	17,50	23,5x33,5(A4)	4



# MATISSE



**MATERIAL:** Simil-Piel  
**SELLO · SEAL:** Termosellado en color negro · Heat-sealed in black colour  
**FIJACIÓN · FIXINGS:** Fundas fijas · Fixed covers

**Porta menú Matisse**  
 Porte-menu · Speisekartenmappe  
 Menu cover · Porta menu

Ref	€	cm	Fundas	U.Venta
A 28051	25,10	23x32 (A4)	4	4
B 28052	19,10	16x28,5	4	4
C 28053	20,00	17x23,5 (A5)	4	4



# CHARLOTTE



**MATERIAL:** Simil-Piel  
**SELLO · SEAL:** Termosellado en color negro · Heat-sealed in black colour  
**FIJACIÓN · FIXINGS:** Atornillado interior · Interior screwed



Blando - Soft

**Porta menú Charlotte**  
 Porte-menu · Speisekartenmappe  
 Menu cover · Porta menu

Ref	€	cm	Fundas	U.Venta
A 28530	38,70	25,5x32 (A4)	3	4
B 28531	33,60	18x28,5	3	4
C 28532	33,00	19x23,5 (A5)	3	4

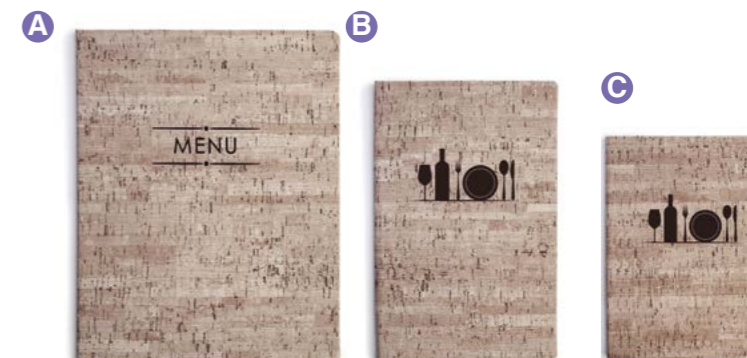

# TOMASSO



**MATERIAL:** Simil-Piel  
**SELLO · SEAL:** Termosellado en color negro · Heat-sealed in black colour  
**FIJACIÓN · FIXINGS:** Atornillado exterior · Exterior screwed

**Porta menú Tomasso**  
 Porte-menu · Speisekartenmappe  
 Menu cover · Porta menu

Ref	€	cm	Fundas	U.Venta
A 28351	26,50	25,5x32 (A4)	3	4
B 28352	21,80	19,5x32	3	4
C 28353	20,50	19x23,5 (A5)	3	4



# DEGAS



**MATERIAL:** Simil-Piel  
**SELLO · SEAL:** Termosellado en color negro · Heat-sealed in black colour  
**FIJACIÓN · FIXINGS:** Solapas · Fixed flaps



**Porta menú Degas**  
 Porte-menu · Speisekartenmappe  
 Menu cover · Porta menu

Ref	€	cm	U.Venta
28141	22,90	23x32 (A4)	4

# GOYA



**MATERIAL:** Simil-Piel  
**SELLO · SEAL:** Termosellado en color negro · Heat-sealed in black colour  
**FIJACIÓN · FIXINGS:** 3 solapas fijas · 3 fixed flaps



**Porta menú Goya**  
 Porte-menu · Speisekartenmappe  
 Menu cover · Porta menu

Ref	€	cm	Solapas	U.Venta
28161	30,30	23x32 (A4)	3	4

# MARCEL



**MATERIAL:** Simil-Piel  
**SELLO · SEAL:** Termosellado en color negro · Heat-sealed in black colour  
**FIJACIÓN · FIXINGS:** 3 solapas fijas · 3 fixed flaps

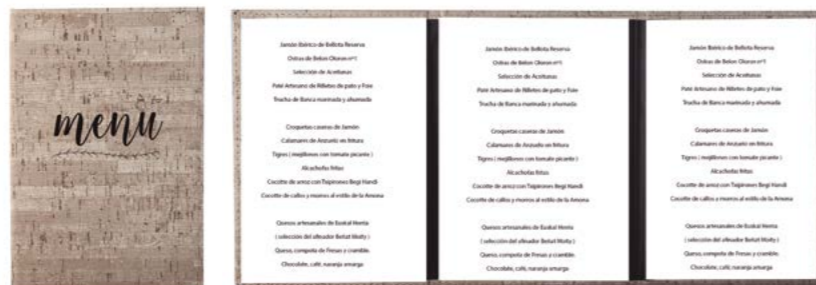

**Porta menú Marcel**  
 Porte-menu · Speisekartenmappe  
 Menu cover · Porta menu

Ref	€	cm	Solapas	U.Venta
28182	27,70	17x24 (A5)	3	4

# CASSAT



**MATERIAL:** Teflex  
**SELLO · SEAL:** Termosellado en color negro · Heat-sealed in black colour  
**FIJACIÓN · FIXINGS:** Sujeción fija · Fixed covers

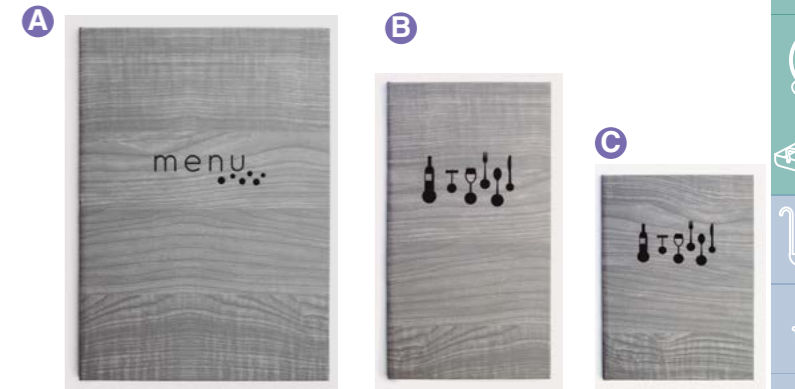

**Porta menú Cassat**  
 Porte-menu · Speisekartenmappe  
 Menu cover · Porta menu

	Ref	€	cm	Fundas	U.Venta
A	28061	21,80	23x32 (A4)	4	4
B	28062	16,30	16x28,5	4	4
C	28063	17,00	17x23,5 (A5)	4	4

# EDGAR



**MATERIAL:** Teflex  
**SELLO · SEAL:** Termosellado en color negro · Heat-sealed in black colour  
**FIJACIÓN · FIXINGS:** Atornillado exterior · Interior screwed



**Porta menú Edgar**  
 Porte-menu · Speisekartenmappe  
 Menu cover · Porta menu

Ref	€	cm	Fundas	U.Venta
28540	23,00	25,5x32 (A4)	3	4

# MAX



**MATERIAL:** Teflex  
**FIJACIÓN · FIXINGS:** Pinza metálica · Metal clip



**Porta menú Max**  
 Porte-menu · Speisekartenmappe  
 Menu cover · Porta menu

Ref	€	cm	U.Venta
28311	14,10	23,5x33,5(A4)	4

# DALÍ



**MATERIAL:** Simil-Piel  
**SELLO · SEAL:** Termosellado en color blanco · Heat-sealed in white colour  
**FIJACIÓN · FIXINGS:** Fundas fijas · Fixed covers

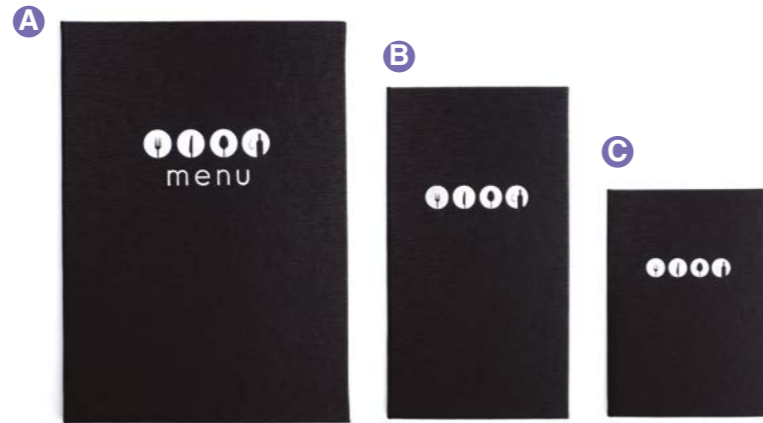

**Porta menú Dalí**  
 Porte-menu · Speisekartenmappe  
 Menu cover · Porta menu

	Ref	€	cm	Fundas	U.Venta
A	28101	23,30	23x32 (A4)	4	4
B	28102	17,90	16x28,5	4	4
C	28103	18,80	17x23,5 (A5)	4	4

# MARIE



**MATERIAL:** Simil-Piel  
**SELLO · SEAL:** Termosellado en color blanco · Heat-sealed in white colour  
**FIJACIÓN · FIXINGS:** Solapas fijas · Fixed flaps



**Porta menú Marie**  
 Porte-menu · Speisekartenmappe  
 Menu cover · Porta menu

	Ref	€	cm	U.Venta
	28560	20,50	23x32 (A4)	4

# FRIDA



**MATERIAL:** Simil-Piel  
**SELLO · SEAL:** Termosellado en color negro · Heat-sealed in black colour  
**FIJACIÓN · FIXINGS:** Fundas fijas · Fixed covers

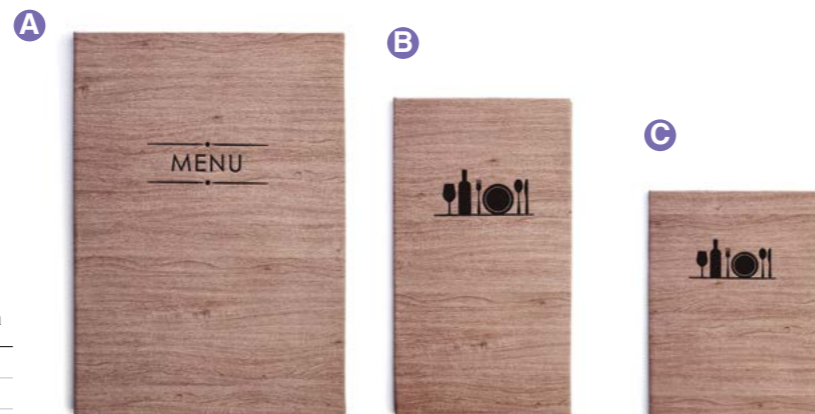

**Porta menú Frida**  
 Porte-menu · Speisekartenmappe  
 Menu cover · Porta menu

	Ref	€	cm	Fundas	U.Venta
A	28011	25,10	23x32 (A4)	4	4
B	28012	19,10	16x28,5	4	4
C	28013	20,00	17x23,5 (A5)	4	4

# VERMEER



**MATERIAL:** Simil-Piel  
**SELLO · SEAL:** Termosellado en color negro · Heat-sealed in black colour  
**FIJACIÓN · FIXINGS:** Atornillado interior · Interior screwed



Blando - Soft

**Porta menú Vermeer**  
 Porte-menu · Speisekartenmappe  
 Menu cover · Porta menu

	Ref	€	cm	Fundas	U.Venta
A	28500	38,70	25,5x32 (A4)	3	4
B	28501	33,00	18x28,5	3	4
C	28502	33,60	19x23,5 (A5)	3	4

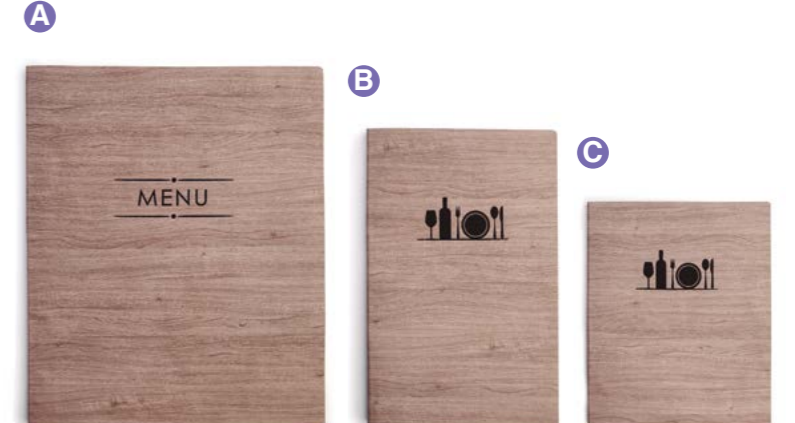

# SOPHIE



**MATERIAL:** Teflex  
**SELLO · SEAL:** Termosellado en color negro · Heat-sealed in black colour  
**FIJACIÓN · FIXINGS:** Fundas fijas · Fixed covers

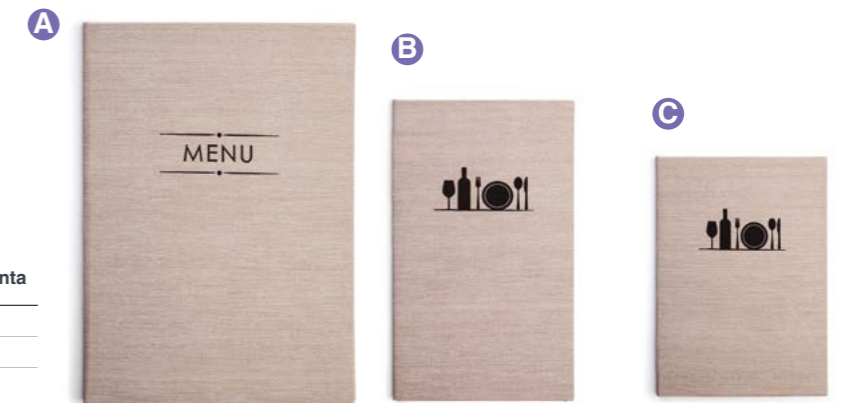

**Porta menú Sophie**  
 Porte-menu · Speisekartenmappe  
 Menu cover · Porta menu

	Ref	€	cm	Fundas	U.Venta
A	28081	22,40	23x32 (A4)	4	4
B	28082	17,00	16x28,5	4	4
C	28083	17,50	17x23,5 (A5)	4	4

# PAUL



**MATERIAL:** Teflex  
**SELLO · SEAL:** Termosellado en color negro · Heat-sealed in black colour  
**FIJACIÓN · FIXINGS:** Atornillado exterior · Interior screwed



**Porta menú Paul**  
 Porte-menu · Speisekartenmappe  
 Menu cover · Porta menu

	Ref	€	cm	Fundas	U.Venta
	28550	24,90	25,5x32 (A4)	3	4

# PABLO



**MATERIAL:** Simil-Piel

**SELLO · SEAL:** Termosellado en color blanco · Heat-sealed in white colour

**FIJACIÓN · FIXINGS:** Atornillado interior · Interior screwed

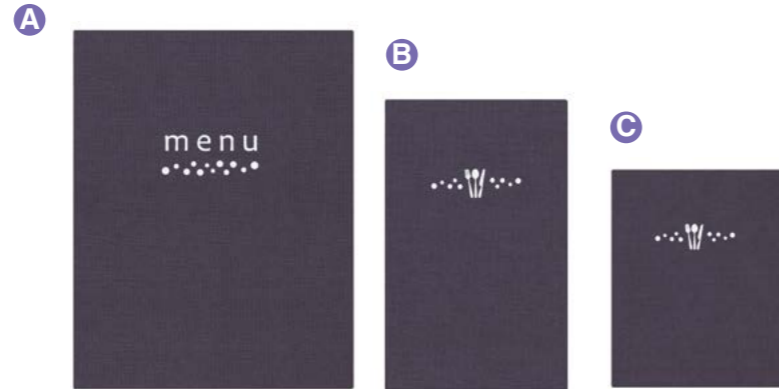

## Porta menú Pablo

Porte-menu · Speisekartenmappe  
Menu cover · Porta menu

	Ref	€	cm	Fundas	U.Venta
<b>A</b>	28211	<b>30,80</b>	25x32 (A4)	3	4
<b>B</b>	28212	<b>25,80</b>	18x28	3	4
<b>C</b>	28213	<b>24,90</b>	19,5x23,5 (A5)	3	4

# ISABELLE



**MATERIAL:** Simil-Piel

**SELLO · SEAL:** Termosellado en color plata · Heat-sealed in silver colour

**FIJACIÓN · FIXINGS:** Fundas fijas · Fixed covers



## Porta menú Isabelle

Porte-menu · Speisekartenmappe  
Menu cover · Porta menu

	Ref	€	cm	Fundas	U.Venta
<b>A</b>	28001	<b>27,10</b>	23x32 (A4)	4	4
<b>B</b>	28002	<b>20,20</b>	16x28,5	4	4
<b>C</b>	28003	<b>21,30</b>	17x23,5 (A5)	4	4

# MILLET



**MATERIAL:** Simil-Piel

**SELLO · SEAL:** Termosellado en color negro · Heat-sealed in black colour

**FIJACIÓN · FIXINGS:** Fundas fijas · Fixed covers

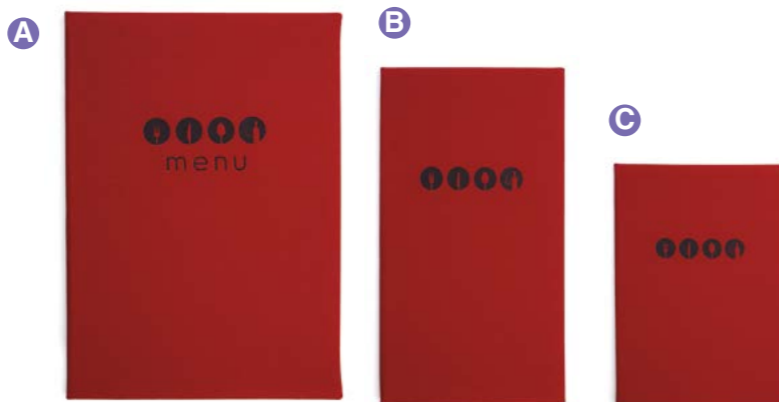

## Porta menú Millet

Porte-menu · Speisekartenmappe  
Menu cover · Porta menu

	Ref	€	cm	Fundas	U.Venta
<b>A</b>	28131	<b>23,30</b>	23x32 (A4)	4	4
<b>B</b>	28132	<b>17,90</b>	16x28,5	4	4
<b>C</b>	28133	<b>18,80</b>	17x23,5 (A5)	4	4

Buffet  
Buffet





# Chafing dish



**Chafing dish GN 1/1 Luxe**  
Chafing dish GN 1/1 · Chafing Dish, GN-Einsatz 1/1  
GN 1/1 chafing dish · Chafing dish GN 1/1

Ref	€	cm	h (cm)	L	U.Venta
69091	<b>1038,20</b>	47x59,5	43,0	9,0	1



**Chafing dish GN 1/1 Luxe Cuerpo**  
Corps chafing dish GN 1/1 · Chafing Dish Körpe, GN-Einsatz 1/1  
GN 1/1 chafing dish body · Corpo chafing dish GN 1/1

Ref	€	cm	h (cm)	L	U.Venta
69099	<b>835,30</b>	59,5x47	25,0	9,0	1

**Placa encastrable. Necesita agujero de Ø216 mm para introducirla**  
Encastable plate. Need a Ø216 mm hole to insert the plate



**Placa de inducción para chafing dish 1000W**  
Plaque à induction a/regulateur · Induktionskochfeld m/ regler  
Round induction plate with power control · Placa de indução com regulador

Ref	€	W	cm	U.Venta
69131	<b>117,00</b>	1000	Ø24x8	1



**Chafing dish GN 1/1 Luxe Soporte**  
Support chafing dish GN 1/1 · Gestell für Chafing Dish1/1  
GN 1/1 chafing dish stand · Suporte chafing dish GN 1/1

Ref	€	cm	h (cm)	U.Venta
69089	<b>202,80</b>	41x55	17,0	1



**Aro completo chafing dish**  
Support plaque induction · Zusatzring chafing-dish  
Chafing-dish heater holde · Aro complemento chafing dish

Ref	€	Ø (cm)	U.Venta
R69099B	<b>19,20</b>	26	1



**Salsera para chafing dish**  
Saucière chafing-dish · Sauciere Chafing Dish  
Gravy spoon holder · Molheira chafing dish

Ref	€	cm	h(cm)	L	U.Venta
R69099C	<b>16,30</b>	12x23	4,0	0,40	1

**Chafing dish GN 2/3 Luxe**  
Chafing dish GN 2/3 · Chafing Dish, GN-Einsatz 2/3  
GN 2/3 chafing dish · Chafing dish GN 2/3

Ref	€	cm	h (cm)	L	U.Venta
69092	<b>826,70</b>	43x46	58,5	5,5	1



**Chafing dish GN 2/3 Luxe Cuerpo**  
Corps chafing dish GN 2/3 · Chafing Dish Körpe, GN-Einsatz 2/3  
GN 2/3 chafing dish body · Corpo chafing dish GN 2/3

Ref	€	cm	h(cm)	L	U.Venta
69095	<b>653,00</b>	46x43	25,5	5,5	1

**Placa encastrable. Necesita agujero de Ø216 mm para introducirla**  
Encastable plate. Need a Ø216 mm hole to insert the plate



**Placa de inducción para chafing dish 1000W**  
Plaque à induction a/regulateur · Induktionskochfeld m/ regler  
Round induction plate with power control · Placa de indução com regulador

Ref	€	W	cm	U.Venta
69131	<b>117,00</b>	1000	Ø24x8	1



**Chafing dish GN 2/3 Luxe Soporte**  
Support chafing dish GN 2/3 · Gestell für Chafing Dish 2/3  
GN 2/3 chafing dish stand · Suporte chafing dish GN 2/3

Ref	€	cm	h(cm)	U.Venta
69087	<b>173,70</b>	40x37	17,0	1



**Aro completo chafing dish**  
Support plaque induction · Zusatzring chafing-dish  
Chafing-dish heater holde · Aro complemento chafing dish

Ref	€	Ø (cm)	U.Venta
R69099B	<b>19,20</b>	26	1



**Salsera para chafing dish**  
Saucière chafing-dish · Sauciere Chafing Dish  
Gravy spoon holder · Molheira chafing dish

Ref	€	cm	h(cm)	L	U.Venta
R69099C	<b>16,30</b>	12x23	4,0	0,40	1



### Chafing dish GN 1/2 Luxe

Chafing dish GN 1/2 · Chafing Dish, GN-Einsatz 1/2  
GN 1/2 chafing dish · Chafing dish GN 1/2 steel

Ref	€	cm	h(cm)	L	U.Venta
69093	745,00	32,5x46	44,5	4,0	1



### Chafing dish GN 1/2 Luxe Cuerpo

Corps chafing dish GN 1/2 · Chafing Dish Körper, GN-Einsatz 1/2  
GN 1/2 chafing dish body · Corpo chafing dish GN 1/2

Ref	€	cm	h(cm)	L	U.Venta
69094	601,60	46x32,5	25,5	4,0	1



### Chafing dish GN 1/2 Luxe Soporte

Support chafing dish GN 1/2 · Gestell für Chafing Dish 1/2  
GN 1/2 chafing dish stand · Suporte chafing dish GN 1/2

Ref	€	cm	h(cm)	U.Venta
69088	143,30	40x28	17,0	1

### Chafing dish sopa Luxe

Chafing dish soupierie · Suppen Chafing Dish  
Soup chafing dish · Chafing dish sopa

Ref	€	Ø (cm)	h (cm)	L	U.Venta
69098	658,40	45	57,0	11,0	1



### Chafing dish sopa Luxe Cuerpo

Corps chafing dish soupierie · Suppen Chafing Dish Körper  
Soup chafing dish body · Corpo chafing dish sopa

Ref	€	Ø (cm)	h (cm)	L	U.Venta
69100	483,90	45	38,0	11,0	1

### Soporte para chafing dish (sopa y redondo Luxe)

Support bain marie soupierie · Gestell für Suppen Chafing Dish  
Soup chafing dish stand · Suporte chafing dish sopa

Ref	€	cm	h (cm)	U.Venta
69097	174,60	41x32	17,0	1

Placa encastrable. Necesita agujero de Ø216 mm para introducirla  
Encastable plate. Need a Ø216 mm hole to insert the plate



### Aro completo chafing dish

Support plaque induction · Zusatzring chafing-dish  
Chafing-dish heater holde · Aro complemento chafing dish

Ref	€	Ø (cm)	U.Venta
R69094A	19,40	18	1



Placa encastrable. Necesita agujero de Ø216 mm para introducirla  
Encastable plate. Need a Ø216 mm hole to insert the plate



### Placa de inducción para chafing dish 1000W

Plaque à induction a/regulateur · Induktionskochfeld m/ regler  
Round induction plate with power control · Placa de indução com regulador

Ref	€	W	cm	U.Venta
69131	117,00	1000	Ø24x8	1



### Aro complemento para chafing dish

Support plaque induction · Zusatzring chafing-dish  
Chafing-dish heater holde · Aro complemento chafing dish

Ref	€	Ø (cm)	U.Venta
R69100B	19,80	27	1

### Placa de inducción para chafing dish 700W

Plaque à induction a/regulateur · Induktionskochfeld m/ regler  
Round induction plate with power control · Placa de indução com regulador

Ref	€	W	cm	U.Venta
69139	116,30	700	Ø18x8	1

### Salsera para chafing dish

Saucière chafing-dish · Sauciere Chafing Dish  
Gravy spoon holder · Molheira chafing dish

Ref	€	cm	h(cm)	L	U.Venta
R69099C	16,30	12x23	4,0	0,40	1



### Salsera para chafing dish

Saucière chafing-dish · Sauciere Chafing Dish  
Gravy spoon holder · Molheira chafing dish

Ref	€	cm	h(cm)	L	U.Venta
R69099C	16,30	12x23	4,0	0,40	1



### Contenedor chafing dish Luxe Sopa

Réceptier pour chafing dish · Behälter für Chafing Dishes  
Chafing dish container · Recipiente para travessas

Ref	€	Ø (cm)	h(cm)	L	U.Venta
R69100A	25,80	29	22,0	11,0	1



### Chafing dish redondo Luxe

Chafing dish rounde · Chafing Dish, rund  
Round chafing dish · Chafing dish redondo

Ref	€	cm	h (cm)	L	U.Venta
69101	<b>818,20</b>	46,5x53	45,0	6,0	1



### Chafing dish redondo Luxe Cuerpo

Corps chafing dishrounde · Chafing Dish Körper, rund  
Round chafing dish body · Corpo chafing dish redondo

Ref	€	cm	h(cm)	L	U.Venta
69096	<b>643,60</b>	46,5x53	25,0	6,0	1

Placa encastrable. Necesita agujero de Ø216 mm para introducirla  
Encastable plate. Need a Ø216 mm hole to insert the plate



### Placa de inducción para chafing dish 1000W

Plaque à induction a/regulateur · Induktionskochfeld m/ regler  
Round induction plate with power control · Placa de indução com regulador

Ref	€	W	cm	U.Venta
69131	<b>117,00</b>	1000	Ø24x8	1



### Salsera para chafing dish

Saucière chafing-dish · Sauciere Chafing Dish  
Gravy spoon holder · Molheira chafing dish

Ref	€	cm	h(cm)	L	U.Venta
R69099C	<b>16,30</b>	12x23	4,0	0,40	1

### Soporte para chafing dish (sopa y redondo Luxe)

Support bain marie soupere · Gestell für Suppen Chafing Dish  
Soup chafing dish stand · Suporte chafing dish sopa

Ref	€	cm	h (cm)	U.Venta
69097	<b>174,60</b>	41x32	17,0	1



### Aro complemento para chafing dish

Support plaque induction · Zusatzring chafing-dish  
Chafing-dish heater holde · Aro complemento chafing dish

Ref	€	Ø (cm)	U.Venta
R69100B	<b>19,80</b>	27	1



### Fuente para chafing dish redondo

Plat rond pour Bain marie rounde · Einsatz für chafing-dish, rund  
Food pan for round chafing-dish · Travessa para chafing dish redondo

Ref	€	Ø (cm)	U.Venta
69019	<b>60,90</b>	35x7	1



INOX  
18/10



### Chafing dish GN 1/1 roll top Latón

Bain marie GN 1/1 roll top · Chafing Dish, mit GN-Einsatz, Rolldeckel  
Chafing dish GN 1/1 roll top · Chafing dish GN 1/1 roll top

Ref	€	cm	h(cm)	L	U.Venta
69015	<b>774,90</b>	53x32,5	6,50	9,0	1



INOX  
18/10

### Chafing dish GN 1/1 con tapa Classic

Bain marie GN 1/1 avec couvercle · Chafing Dish, mitGN-Einsatz 1/1 mit Deckel  
Chafing Dish GN 1/1 with lid · Chafing Dish GN 1/1 com tampa

Ref	€	cm	h(cm)	L	U.Venta
69110	<b>110,00</b>	56x35	28,0	8,5	1



INOX

### Contenedor de combustible

Porte-bruleur · Brennpasten-Behälter  
Burner holder · Recipiente de combustivel

Ref	€	Ø (cm)	h(cm)	U.Venta
69006	<b>10,80</b>	9,0	6,0	1

INOX  
18/10



### Chafing dish GN 1/1 roll top Inox

Bain marie GN 1/1 roll top · Chafing Dish, mit GN-Einsatz, Rolldeckel  
Chafing dish GN 1/1 roll top · Chafing dish GN 1/1 roll top

Ref	€	cm	h(cm)	L	U.Venta
69034	<b>695,30</b>	53x32,5	6,50	9,0	1



Adapt. a Ref  
69015 - 69001 - 69004 - 69110

INOX CE

### Calentador eléctrico para chafing

Corp de chauffe pour bain marie · Heizung für chafing dish  
Heating unit for chafing dish · Aquecedor para chafing dish

Ref	€	W	Temperatura	U.Venta
A 69002	<b>190,70</b>	700	96°C(máx)	1
B 69012	<b>220,60</b>	700	92°C(máx)	1



### Gel combustible Etanol

Gel chauffe ETHANOL · Brennpaste, ETHALKOHOL  
Fuel gel, ETHANOL · Gel combustivel ETANOL

Ref	€	Peso (Kg)	Horas	U.Venta
A 71780	<b>4,90</b>	0,08	80 min	1
B 69108	<b>2,80</b>	0,225	3	72
C 69107	<b>8,80</b>	0,840	-	1
D 69109	<b>40,50</b>	4,00	-	1

Set 3 latas · 3 can set  
Lata · Can  
Botella · Bottle  
Bidón · Barrel

INOX  

**new**



- Diseño elegante, práctico y funcional.
- Fabricada en acero inoxidable de gran calidad.
- Carcasa fabricada en polipropileno.
- Panel de control digital para controlar la temperatura real y la temperatura programada (ajustable entre los 20°C y los 80°C).
- Tapa de acero inoxidable con apertura central y orificio para apoyar el cazo (Ref.: 69680).
- Tapa de vidrio templado con sistema de cierre SoftClosing incluye un tirador con aislamiento térmico (Ref.: 69681-69682).
- Recipiente y tapa fabricadas en acero inoxidable, totalmente extraíbles que garantizan que sea cómodo a la hora de llenarlo y muy fácil de limpiar.
- Ligero y fácil de transportar.
- Pies de goma antideslizantes para mayor estabilidad.

- Design élégant, pratique et fonctionnel.
- Fabriqué en acier inoxydable de haute qualité.
- Boîtier en polypropylène.
- Panneau de commande numérique permettant la température réelle et la température programmée (réglable entre 20°C et 80°C).
- Couvercle en acier inoxydable avec ouverture centrale et trou pour supporter la casserole (Ref.: 69680).
- Couvercle en verre trempé avec système SoftClosing et poignée isolée thermiquement (Ref.: 69681-69682).
- Récipient et couvercle en acier inoxydable, entièrement amovibles pour faciliter le remplissage et le nettoyage.
- Léger et facile à transporter.
- Pieds en caoutchouc antidérapants pour une meilleure stabilité.

- Elegant, practical and functional design.
- Made of high quality stainless steel.
- Housing made of polypropylene.
- Digital control panel to monitor the actual temperature and the programmed temperature (adjustable between 20°C and 80°C).
- Stainless steel lid with central opening and hole to support the saucepan (Ref.: 69680).
- Tempered glass lid with SoftClosing system including thermally insulated handle (Ref.: 69681-69682).
- Stainless steel container and lid, fully removable to ensure convenient filling and easy cleaning.
- Lightweight and easy to transport.
- Non-slip rubber feet for greater stability.

### Chafing Dish SOPA NOIR

Soupe pour chafing dish · Chafing Dish Suppe  
Chafing Dish Soup · Sopa de Chafing Dish

Ref	€	W	L	h(cm)	Rango temperatura	U.Venta
69680	229,40	400	3,2	35	20°C - 80°C	1



### Chafing Dish GN 1/1 NOIR

Casserole GN 1/1 · Chafing Dish GN 1/1  
Chafing Dish GN 1/1 · Sopa de Chafing Dish

Ref	€	W	L	h(cm)	Rango temperatura	U.Venta
69681	292,10	600	6,0	20	20°C-80°C	1



### Chafing Dish GN 2/3 NOIR

Casserole GN 2/3 · Chafing Dish GN 2/3  
Chafing Dish GN 2/3 · Sopa de Chafing GN 2/3

Ref	€	W	L	h (cm)	Rango temperatura	U.Venta
69682	274,40	600	4,0	20	20°C - 80°C	1

### Combinaciones posibles de cubetas · Possible tray options



INOX  

### Chafing dish eléctrico

Chafing dish électrique · Elektrische Chafing Dish  
Electric chafing dish · Chafing dish eléctrico

Ref	€	W	L	U.Venta
69336	183,00	900	8,5 L	1

- Ideal para el sector de la hostelería, restauración y catering.
- Mantiene la temperatura de los alimentos.
- Más seguro al carecer de llama de los geles.
- Tapa y cubeta extraíble GN 1/1 h=65 mm (8,50 L) fabricados en acero inoxidable de alta calidad. Cuerpo fabricado en polipropileno.
- Termostato regulable (85°C +/-10°C).
- Interruptor de encendido y apagado. Indicador luminoso.
- Protección contra sobrecalentamiento.
- Fácil de transportar gracias a sus asas laterales.
- 6 pies antideslizantes y resistentes para mantener la estabilidad.

- Ideal for the hospitality, restoration and catering sector.
- Keep the food temperature.
- Safer lacking the flame of the gels.
- Removable lid and cubeta Gn 1/1 h = 65 mm (8.50 l) Manufactured in high quality stainless steel. Body manufactured in polypropylene.
- Adjustable thermostat (85 ° C +/- 10 ° C).
- Switch on and off. Luminous indicator.
- Overheating protection.
- Easy to transport thanks to your lateral handles.
- 6 non -slip and resistant feet to maintain the establishment.

## Ollas calentadoras

INOX 18/10  

- Mantiene caliente todo tipo de sopas, salsas, consomés y líquidos.
- Ideal para cantidades grandes.

- Il maintient toutes sortes de soupes, sauces, consommées et liquides chaudes.
- Idéal pour de grandes quantités.

- It keeps all kinds of soups, sauces, consomme and liquids hot.
- Ideal for large amounts.



### Olla calentadora sopa Profesional

Marmite Buffet chaud · Suppen-und Speisenwärmer  
Soup kettle · Panela aquecedora de sopa

	Ref	€	W	Temperatura	Capacidad	Medidas	U.Venta
A	69267	297,80	800 W	30°C-90°C	10L	Ø33x32 cm	1
B	69037	178,70	400 - 475 W	30°C-90°C	11L	Ø34,5 x 36 cm	1
C	69038	251,90	400 - 475 W	30°C-90°C	10L	Ø34,5x36 cm	1

### Repuesto recipiente (69037-69038)

Récipient de rechange (69037-69038) · Ersatzbehälter (69037-69038)  
Spare container (69037-69038) · Recipiente de reserva (69037-69038)

Ref	€	L	U.Venta
69039	59,70	10	1



# Dispensadores y servidores



CRO  
Cromado  
Chrome



INOX  
18/10

## Servidor de zumos cromado

Distributeur de jus en inox · Saftbehälter mit rostfreiem Fuss  
Juice dispenser mirror stand · Distribuidor de zumos pé cromado

Ref	€	L	U.Venta
69027	<b>340,90</b>	8,70	1
R69027	<b>97,50</b>	8,70	1
R69018	<b>29,60</b>	-	1

**A** Contenedor · Container  
**B** Grifo · Tap

Boca ancha para cubitos hielo  
Wide mouth for ice cubes

Doble pared  
Double wall

INOX

## Air Pot

Air pot · Getränkespender, isoliert  
Air pot · Air pot

Ref	€	L	h (cm)	U.Venta
62472	<b>71,50</b>	2,50	32,5	1
62473	<b>77,60</b>	3,00	34,5	1
62475	<b>104,00</b>	4,00	39,0	1

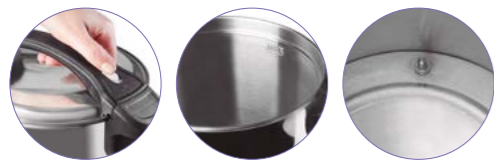

Fácil apertura. Marcas de llenado  
Sensor de temperatura

Easy open system. Fill lines. Temperature sensor

INOX

## Airpot eléctrico termosificador

Électrique Airpot · Elektrische Getränkespender  
Electric Airpot · Airpot eléctrico

Ref	€	W	Capacidad	Temperatura	Medidas	U.Venta
69472	<b>134,60</b>	1500	4L	60°C-100°C	28x28x35 cm	1
69476	<b>145,50</b>	1500	6L	60°C-100°C	28x28x40 cm	1
69471	<b>158,80</b>	1500	10L	60°C-100°C	28x28x48 cm	1



## Calentador de líquidos para buffet

Chauffe-café · Getränkebehälter  
Coffee urn · Aquecedor de líquidos

Ref	€	L	U.Venta
69028	<b>382,90</b>	11,00	1
R69018	<b>29,60</b>	-	1

**Grifo** · Tap

## NO UTILIZAR CON BEBIDAS GASEOSAS, CALDOS NI LÁCTEOS

DO NOT USE WITH FI ZZY DRINKS, BROTHS OR DAIRY



- Mantiene las bebidas calientes o frías durante 24 horas.
- Doble pared que proporciona un alto rendimiento térmico.
- Ligero e irrompible.
- Boca ancha para cubos de hielo.
- Fácil de abrir y cerrar. Fácil limpieza.

- Gardez les boissons chaudes ou froides pendant 24 heures.
- Double paroi qui offre des performances thermiques élevées.
- Léger et incassable.
- Bouche large pour les glaçons.
- Facile à ouvrir et à fermer. Nettoyage facile.

- Keep hot or cold drinks for 24 hours.
- Double wall that provides high thermal performance.
- Light and unbreakable.
- Wide mouth for ice cubes.
- Easy to open and close. Easy cleaning.

## NO UTILIZAR CON BEBIDAS GASEOSAS, CALDOS NI LÁCTEOS

DO NOT USE WITH FI ZZY DRINKS, BROTHS OR DAIRY

- Fabricado en acero inoxidable resistente y de alta calidad.
- Calienta y mantiene el agua a una temperatura óptima.
- Dispone de un grifo dispensador con indicador de nivel de líquido.
- Temperatura controlada por termostato con un rango de 60°C a 100°C. Sensor de temperatura en el interior.
- Dispone de asas laterales aislantes del calor para un desplazamiento seguro.
- Fácil sistema de apertura y nivel de indicador de líquido. Con marcas de llenado en su interior.
- Sistema de dispensado cómodo y bandeja de goteo.
- Nota: utilizar solamente con agua.

- Heat and keep the water at an optimal temperature.
- It has a dispenser tap with liquid level indicator.
- Thermostat controlled temperature with a range of 60°C to 100°C. Temperature sensor inside.
- It has heat -insulating side handles for safe displacement.
- Easy opening system and liquid indicator level. With filling marks inside.
- Comfortable dispensing system and drip tray.
- Note: Use only with water.

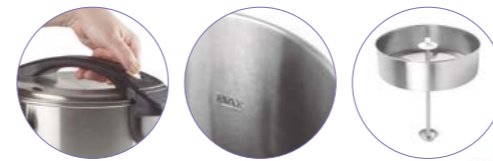

Fácil apertura. Marcas de llenado  
Filtro microperforado  
Easy open system · Fill lines  
Micro-perforated filter

INOX



## Cafetera percoladora

Percolateur à café · Kaffee-Perkolator  
Coffee percolator · Máquina/Percolador de café

Ref	€	W	Capacidad	Medidas	U.Venta
69486	<b>167,30</b>	1500	6L	28x28x40 cm	1
69481	<b>186,70</b>	1500	10L	35x35x45 cm	1



INOX  
18/10



## Dispensador de leche

Dispensateur de lait · Milchkanne mit Fuß  
Milk dispenser with base · Distribuidor de leite

Ref	€	L	Medidas	U.Venta
69030	<b>423,60</b>	5,5	22x33x44 cm	1

**Grifo dispensador**  
Dispensing tap



- Permite su uso para calentamiento como para refrigeración.
- Il permet son utilisation pour le chauffage comme pour la réfrigération.
- It allows its use for heating as for refrigeration.



ASA  
Acrylic



## Organizador de café

Organisateur de café · Kaffee Veranstalter  
Coffee organizer · Organizador de café

Ref	€	cm	h(cm)	U.Venta
<b>A</b> 62280	<b>10,70</b>	11,5x11,5	20	1
<b>B</b> 62281	<b>38,90</b>	35,5x26,5	18	1
<b>C</b> 62283	<b>71,00</b>	35,5x26,5	31	1

- Fabricada en acero inoxidable de gran calidad.
- Ideal para cafeterías, restaurantes, bares, servicios de buffet y estaciones self-service.
- 2 sistemas de calentamiento independientes para la función de infusión y la función de conservación del calor.
- Distribución de calor rápida y homogénea.
- Mantiene el café a la temperatura óptima salvaguardando sus propiedades de sabor y aroma durante horas.
- Filtro de malla microperforada de acero inoxidable, especialmente diseñado para evitar la generación de posos.
- Luz indicadora de preparación. Indicador del nivel de agua. Bandeja antigoteo.
- Tapa con cierre de seguridad mediante botón de bloqueo.
- Sistema de protección contra el calentamiento en vacío.
- Opción de lujo continuo para una máxima comodidad.
- Tapa, filtro y tubo percolador aptos para el lavavajillas.

- Made of high quality stainless steel.
- Ideal for coffee shops, restaurants, bars, buffet services and Self-Service stations.
- 2 independent heating systems for infusion function and heat conservation function.
- Fast and homogeneous heat distribution.
- Keep coffee at the optimal temperature safeguarding its flavor and aroma properties for hours.
- Stainless steel microperforated mesh filter, specially designed to prevent the generation of posos.
- Preparation indicator light. Water level indicator. Antigoteing tray.
- Safety closure cover using lock button.
- Vacuum warming protection system.
- Continuous luxury option for maximum comfort.
- Cover, filter and percolative tube suitable for dishwasher.

- Soporte organizador para tazas de café, vasos desechables y papel, servilletas, cápsulas de café, azúcar, infusiones, cucharas, etc.
- Fabricado en plástico ABS.
- 4 compartimentos.
- Ideal para mantener todo organizado y presentado de forma atractiva.
- Ideal para cafeterías.
- La referencia 62280 encaja perfectamente sobre la base.
- Fácil limpieza. Apto para el lavavajillas.
- Base muy estable.

- Organizing support for coffee cups, disposable vessels and paper, napkins, coffee capsules, sugar, infusions, spoons, etc.
- Made of ABS plastic.
- 4 compartments.
- Ideal to maintain everything organized and presented in an attractive way.
- Ideal for coffee shops.
- Reference 62280 fits perfectly on the base.
- Easy cleaning. Apt for the dishwasher.
- Very stable base.



ABS  
Plastic

PS  
Plastic



**Sistema dispensador giratorio**  
Rotating dispensing system

**Base ancha; ofrece una mayor estabilidad**  
Wide base for greater stability

### Dispensador de cereales Flor

Distributeur de céréales · Cerealenspender  
Cereal dispenser · Dispensador de cereais

Ref	€	cm	h(cm)	L	U.Venta
62545	<b>24,70</b>	16x20	40	3,50	1



**Tapa hermética**  
Lid hermetic

**Anclaje en pared**  
Wall anchor

**Sistema dispensador giratorio**  
Rotating dispensing system

### Dispensador de cereales de pared Flor

Distributeur de céréales mural · Wandspender für Cerealien  
Wall-mounted cereal dispenser · Dispensador de cereais de parede

Ref	€	cm	h(cm)	L	U.Venta
<b>A</b> 62541	<b>16,90</b>	14,5x12,5	31	1,50	1
<b>B</b> 62542	<b>28,10</b>	28x12,5	31	1,50 x 2	1

**Simple** · Simple

**Doble** · Double

INOX  
18/10



### Dispensador de cereales Inox 18/10

Distributeur de Cereales sur Pied · Cerialenspender mit Fuss  
Cereal Dispenser with Stand · Distribuidor de cereis com base

Ref	€	Ø (cm)	cm	L	U.Venta
<b>A</b> 69022	<b>302,30</b>	18,5	24x34x70	10,0	1
<b>B</b> 69023	<b>598,70</b>	18,5	44x34x70	10,0	1

**Simple** · Simple

**Doble** · Double



**Tapa hermética**  
Lid hermetic



**Sistema dispensador giratorio**  
Rotating dispensing system

**Base ancha; ofrece una mayor estabilidad**  
Wide base for greater stability

### Dispensador de cereales Dual

Distributeur de céréales · Frühstücksflocken Spender  
Cereal dispenser · Dispensador de cereais

Ref	€	L	U.Venta
62596	<b>29,70</b>	2 x 2	1
62597	<b>38,20</b>	3,5 x 2	1

**Conserva la frescura y el sabor de los alimentos por más tiempo**  
Preserves the freshness and taste of food for longer



# Cubetas y cacerolas Inducción

new

INOX  
18/10



- Fabricada en acero inoxidable 18/10 de gran calidad.
- Fondo difusor, compatible con todas las fuentes de calor (incluida la inducción y el horno).
- Distribución rápida y uniforme del calor.
- Recubrimiento interior antiadherente **QuanTanium® reforzado con partículas de titanio; libre de materiales tóxicos y pesados, ecológico y libre de PFOA.**

- Fabriqué en acier inoxydable 18/10 de haute qualité.
- Fond diffuseur, compatible avec toutes les sources de chaleur (y compris l'induction et le four).
- Diffusion rapide et uniforme de la chaleur.
- Revêtement intérieur antiadhésif **QuanTanium®** renforcé par des particules de titane; exempt de matériaux toxiques et lourds, respectueux de l'environnement et sans PFOA.

- Made of high quality 18/10 stainless steel.
- Diffuser bottom, compatible with all heat sources (including induction and oven).
- Fast and even heat distribution.
- Non-stick **QuanTanium®** inner coating reinforced with titanium particles; free of toxic and heavy materials, environmentally friendly and PFOA-free.

Fondo difusor - Diffuser bottom

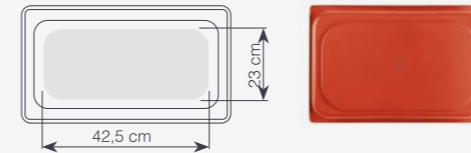

Antiadherente interior - Non-stick interior



### Cubetas Inducción

Batterie de cuisine à induction · Induktionskochgeschirr  
Induction Cookware · Utensílios de cozinha de indução

	Ref	€	cm	h(cm)	L	e (mm)	U.Venta
<b>A</b>	15365	<b>95,90</b>	53x32,5 (GN 1/1)	6,5	8,3	0,7	1
<b>B</b>	15465	<b>95,90</b>	53x32,5 (GN 1/1)	6,5	8,3	0,7	1
<b>C</b>	15565	<b>95,90</b>	53x32,5 (GN 1/1)	6,5	8,3	0,7	1



### Cacerola con tapa Red

Faitout avec couvercle · Bratentopf mit Deckel  
Casserole with lid · Caçarola com tampa

Ref	€	Ø (cm)	h(cm)	L	U. Venta
15316	<b>40,90</b>	16	8,0	1,50	1
15320	<b>48,80</b>	20	10,0	3,00	1
15324	<b>59,10</b>	24	12,0	5,00	1



### Cacerola con tapa White

Faitout avec couvercle · Bratentopf mit Deckel  
Casserole with lid · Caçarola com tampa

Ref	€	Ø (cm)	h(cm)	L	U. Venta
15416	<b>40,90</b>	16	8,0	1,50	1
15420	<b>48,80</b>	20	10,0	3,00	1
15424	<b>59,20</b>	24	12,0	5,00	1



### Cacerola con tapa Ocean

Faitout avec couvercle · Bratentopf mit Deckel  
Casserole with lid · Caçarola com tampa

Ref	€	Ø (cm)	h(cm)	L	U. Venta
15516	<b>40,90</b>	16	8,0	1,50	1
15520	<b>48,90</b>	20	10,0	3,00	1
15524	<b>59,10</b>	24	12,0	5,00	1

### Tapa

Couvercle · Deckel  
Lid · Tampa

Ref	€	Ø (cm)	U.Venta
15306	<b>9,40</b>	16	1
15302	<b>10,40</b>	20	1
15304	<b>11,10</b>	24	1



**Diseñada para colocar en el borde de la cacerola**  
Designed to fit on the rim of the pan



## Bandejas y Buffet Pizarra



- Fabricada en pizarra 100% natural con amplia superficie de apoyo de Ø35 cm.
  - Soporte giratorio de cristal y pie de acero inoxidable, permite una rotación fácil y suave en ambos sentidos.
  - Diseñado para presentar y servir tapas, aperitivos, postres, etc.
  - Fácil limpieza. No es apta para el lavavajillas.
- Made of 100% natural slate and featuring a large Ø 35 cm support surface.
  - Revolving glass dish and stainless steel base for easy, smooth rotation in both directions.
  - Designed to present and serve snacks, dips, appetisers, desserts, etc.
  - Easy to clean. Not dishwasher safe.

Asas de acero inoxidable  
Stainless steel handles

Pizarra 100% natural  
100% natural slate



Almohadillas antideslizantes  
Non-slip pads



### Plato giratorio pizarra natural

Plateau tournant en ardoise naturelle · Drehteller aus Naturschiefer  
Rotating serving dish in natural slate · Prato giratório em ardósia natural

Ref	€	Ø (cm)	h(cm)	U.Venta
61235	20,40	35	2,5	1

### Bandeja pizarra con asas

plateau en ardoise avec poignées · Schieferblett mit Griffen  
Slate tray with handles · Bandeja de ardósia com asas

Ref	€	cm	h(cm)	U.Venta
61230	11,50	40x20	5,0	1
61231	16,60	45,5x30	5,0	1
61232	18,70	53x5x33	5,0	1

### Bandejas extraíbles

Removable trays

Pizarra 100% natural  
100% natural slate

Asa para transportar  
Handle for transport



Estructura de bambú  
Bamboo structure

Desmontable  
Removable

Estructura metálica  
Metal structure

Desmontable  
Removable

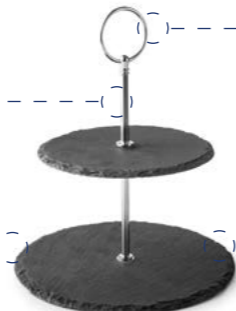

Pizarra 100% natural  
100% natural slate

### Soporte expositor pizarra

Présentoir · Schieferständer  
Display stand · Expositor

Ref	€	Grande cm	Pequeña cm	h(cm)	U.Venta
61233	21,10	35x25	35x15	22	1

### Soporte expositor pizarra

Présentoir · Schieferständer  
Display stand · Expositor

Ref	€	Grande cm	Pequeña cm	h(cm)	U.Venta
61234	8,00	20	15	34	1



## Vajilla catering Degustare



- Vajilla para catering moderna, innovadora y atractiva.
- Ideal para cualquier tipo de celebración como banquetes, bodas, fiestas, etc. Realizan cualquier tipo de catering de alta gama.
- Permite múltiples combinaciones gracias a la variedad de formas.
- Reutilizables e irrompibles. Manejables y ligeros para su transporte.
- 100% apilables.

- Vaisselle pour buffets moderne, innovante et attractive.
- Idéale pour tout type de célébration comme des banquets, mariages, fêtes, etc. Elle sublime tout type de buffet haut de gamme.
- Permet de multiples combinaisons grâce à la variété des formes.
- Pièces réutilisables et incassables. Maniables et légères pour le transport.
- 100% empilable.

- Modern, innovative and attractive catering dinnerware.
- Ideal for any type of celebration, such as banquets, weddings, parties etc. Enhances any kind of high-end catering.
- Perfect for multiple combinations due to the variety of different shapes.
- Reusable and unbreakable.
- Handy and lightweight for transport.
- 100% stackable.

### Bandeja Degustare

Vaisselle pour la restauration · Catering-Geschirr  
Catering dinnerware · Serviço de catering

Ref	€	cm	h(cm)	U.Venta
60750	11,60	42x28,5	2,5	1



### Degustare White

Vaisselle pour la restauration · Catering-Geschirr  
Catering dinnerware · Serviço de catering

	Ref	€	cm	h(cm)	ml	U.Venta
A	60751	7,80	Ø8,5	5,5	115	1
B	60752	8,00	8,5x8,5	5,5	80	1
C	60753	8,10	Ø8,0	4,0	100	1
D	60754	8,00	13x6,5	3,5	35	1
E	60755	7,50	Ø6,0	7,5	65	1
F	60756	9,00	9,5x7,5	5,00	140	1
G	60757	12,60	Ø7,5	7,00	80	1

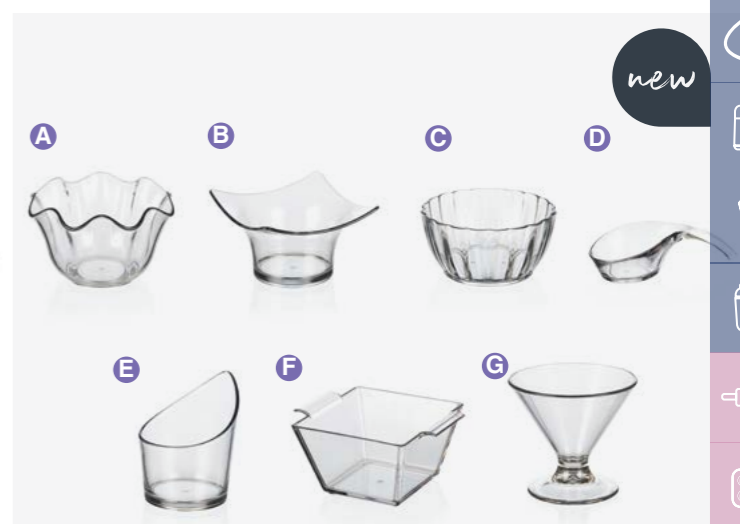

### Degustare Transparent

Fleur bol · Flower bowl  
Bolforn Blume · Bacia flor

	Ref	€	cm	h (cm)	ml	U.Venta
A	60781	8,50	Ø8,5	5,5	115	1
B	60782	8,60	8,5x8,5	5,5	80	1
C	60783	8,90	Ø8,0	4,0	100	1
D	60784	8,70	13x6,5	3,5	35	1
E	60785	8,10	Ø6,0	7,5	65	1
F	60786	9,10	9,5x7,5	5,00	140	1
G	60787	12,60	7,5x7,5	7,00	80	1



## Buffet & Display Melamina mármol



- Fabricados en melamina de alta calidad.
- Aspecto elegante efecto mármol.
- Diseñados para presentar todo tipo de alimentos tanto fríos como calientes (70°C / -20°C).
- Ideales para exponer en todo tipo de buffet, caterings, etc.
- 100% apilables.
- Prácticos y atractivos. Presentan una funcionalidad y durabilidad inmejorables.
- Fácil limpieza: aptas para el lavavajillas.
- Libres de BPA.

- Fabriqué en mélamine de haute qualité.
- Élégant aspect marbré.
- Conçu pour présenter tous types d'aliments, aussi bien chauds que froids (70°C / -20°C).
- Idéal pour la présentation dans tous les types de buffets, traiteurs, etc.
- 100 % empilables.
- Pratiques et attrayants. Fonctionnalité et durabilité imbattables.
- Facile à nettoyer : apte au lave-vaisselle.
- Sans BPA.

- Made of high quality melamine.
- Elegant marble appearance.
- Designed for presenting all kinds of food, both cold and hot (70°C / -20°C).
- Perfect for displaying in all kinds of buffets, catering, etc.
- 100% stackable.
- Practical and attractive. Unbeatable functionality and durability.
- Easy to Clean: dishwasher safe.
- BPA free.

Infinidad de combinaciones posibles · Endless possible combinations

BAJOS · LOW



ALTOS · HIGH

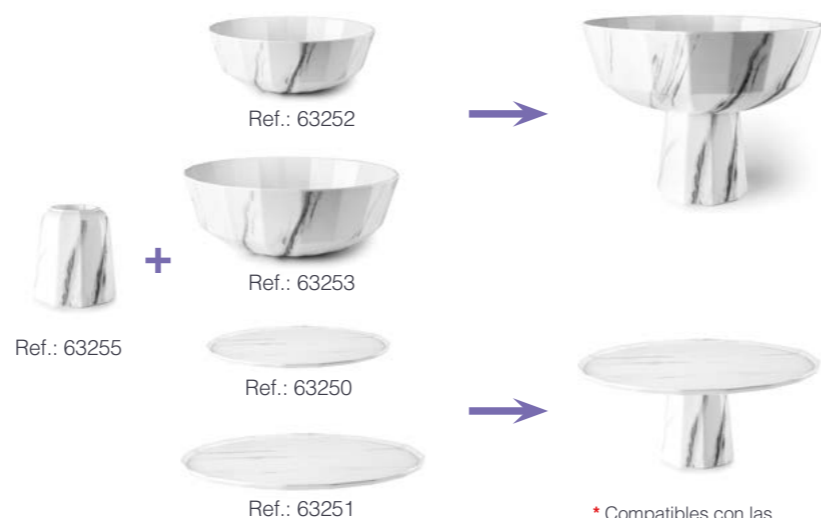

\* Compatibles con las campanas PS (Ref.: 61801-61803)



### Frutero

Corbeille à fruits · Obstschüssel  
Fruit basket · Fruteiro

Ref	€	Ø (cm)	h(cm)	L	U.Venta
63252	29,70	21,3	7,5	1,5	1
63253	50,10	28,5	10,0	3,80	1



### Portatartas

Porte-gâteau · Tortenständer  
Cake stand · Suporte de bolos

Ref	€	Ø (cm)	h(cm)	U.Venta
63250	23,00	22,5	2,0	1
63251	37,20	33,0	2,0	1

### Soporte

Support · Stand  
Stand · Suporte

Ref	€	Ø (cm)	h(cm)	L	U.Venta
63254	9,40	11,5	8,5	0,44	1
63255	11,20	11,5	12,0	0,71	1



**Multifunción.**  
Soporte + vaso  
para servir aperitivos  
Multi-purpose.  
Stand + glass for serving  
aperitifs



### Bandeja

Plateau · Tablett  
Tray · Bandeja

Ref	€	cm	U.Venta
63242	28,10	26,5x32,5 (GN 1/2)	1
63243	30,10	53x16,5 (GN 2/4)	1
63244	55,20	53x65 (GN 1/1)	1

- Fabricadas en melamina de alta calidad. Libres de BPA
- Aspecto elegante efecto mármol.
- Diseñadas para presentar todo tipo de alimentos tanto fríos como calientes (70 / -20°C)
- Ideales para exponer en todo tipo de buffet, caterings, etc.
- 100% apilables.
- Fácil limpieza: aptas para el lavavajillas.

- Fabriqué en mélamine de haute qualité. Sans BPA
- Élégant aspect marbré.
- Conçu pour présenter tous types d'aliments, aussi bien chauds que froids (70 / -20°C).
- Idéal pour la présentation dans tous les types de buffets, traiteurs, etc.
- 100% empilables.
- Facile à nettoyer : passe au lave-vaisselle.

- Made of high quality melamine. BPA free
- Elegant marble effect appearance.
- Designed to present all types of food, both hot and cold (70 / -20°C).
- Ideal for displaying in all types of buffets, caterings, etc.
- 100% stackable.
- Easy to clean: dishwasher safe.



h (cm)



h (cm)

VIDRIO  
Glass



### Campana cubreplatos

Cloche couvre plat · Tellerglocke  
Plate Cover · Campânula cobre-pratos

Ref	€	Ø (cm)	h(cm)	U.Venta
61806	40,50	25	18,5	1
61809	46,30	29	20,3	1
61802	50,10	33	22,3	1

### Campana cubreplatos PS

Cloche couvre plat · Tellerglocke  
Plate Cover · Campânula cobre-pratos

Ref	€	Ø (cm)	h(cm)	U.Venta
61801	6,70	22,0	12,0	1
61803	12,40	30,0	15,5	1



# Colección Nord Buffet

new

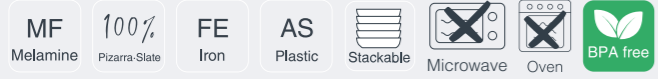

- Una colección moderna diseñada para buffet que incluye soportes, cajas y bandejas.
- Combina materiales de alta calidad como la acacia, la pizarra, la melamina y el hierro.
- Cajas y bandejas apilables fabricadas en medidas gastronorm.
- Su sistema modular permite realizar presentaciones únicas.
- Su diseño facilita la creación de diversas combinaciones, con la posibilidad de ampliarlas según lo exija cada ocasión.
- Compacta y funcional, optimiza el espacio mientras asegura una presentación atractiva y elegante.
- Todos los componentes de madera están tratados para resistir la humedad siendo aptos para el contacto con alimentos.

- Une collection moderne conçue pour les buffets, comprenant des stands, des boîtes et des plateaux.
- Elle combine des matériaux de haute qualité tels que l'acacia, l'ardoise, la mélamine et le fer.
- Boîtes et plateaux empilables en format gastronomique.
- Son système modulaire permet des présentations uniques.
- Sa conception facilite la création de diverses combinaisons, avec la possibilité de les étendre selon les besoins de chaque occasion.
- Compact et fonctionnel, il optimise l'espace tout en assurant une présentation attrayante et élégante.
- Tous les éléments en bois sont traités pour résister à l'humidité et sont adaptés au contact avec les aliments.

- A modern collection designed for buffets including stands, boxes and trays.
- It combines high quality materials such as acacia, slate, melamine and iron.
- Stackable boxes and trays made in gastronorm sizes.
- Its modular system allows for unique presentations.
- Its design facilitates the creation of various combinations, with the possibility of expanding them as required for each occasion.
- Compact and functional, it optimises space while ensuring an attractive and elegant presentation.
- All wooden components are treated to resist humidity and are suitable for contact with food.



**Caja GN 1/1**  
Boîte · Box  
Box · Caixa

Ref	€	Medidas	h (cm)	U.Venta
67914	25,40	53x32,5cm ( GN1/1)	4,5	1
67918	29,20	53x32,5cm ( GN1/1)	8,5	1
67916	39,90	53x32,5cm ( GN1/1)	16,5	1



**Caja GN 1/2**  
Boîte · Box  
Box · Caixa

Ref	€	Medidas	h (cm)	U.Venta
67924	16,90	26,5x32,5cm ( GN 1/2)	4,5	1
67928	20,50	26,5x32,5cm ( GN 1/2)	8,5	1
67926	24,70	26,5x32,5cm ( GN 1/2)	16,5	1



**Caja GN 1/3**  
Boîte · Box  
Box · Caixa

Ref	€	Medidas	h (cm)	U.Venta
67934	14,50	32,5x17x6cm (GN 1/3)	4,5	1
67938	17,60	32,5x17x6cm (GN 1/3)	8,5	1



**Caja GN 2/4**  
Boîte · Box  
Box · Caixa

Ref	€	Medidas	h (cm)	U.Venta
67944	17,60	53x16,2cm (GN 2/4)	4,5	1
67948	21,90	53x16,2cm (GN 2/4)	8,5	1



**Soporte recto**  
Support droit · Gerade Stütze  
Straight support · Suporte reto

Ref	€	cm	U.Venta
67920	22,90	32,5x26,5 (GN 1/2)	1
67910	28,00	53x32,5 (GN 1/1)	1



**Soporte Inclinado**  
Support incliné · Gekippte Stütze  
Tilted support · Suporte inclinado

Ref	€	cm	U.Venta
67921	22,90	32,5x26,5 (GN 1/2)	1
67911	28,00	53x32,5 (GN 1/1)	1



**Bandeja room service**

Plateau de service en chambre · Zimmerservice-Tablett  
Room Service Tray · Bandeja de serviço de quarto

Ref	€	cm	h (cm)	U.Venta
67953	28,30	45x35	6	1



**Caja Cubiertos GN 1/1**

Couverts de table · Schachtel-Besteck  
Box Cutlery · Talheres de caixa

Ref	€	cm	U.Venta
67951	40,70	53x32,5 (GN 1/1)	1



**Cubertero**

Plateau à couverts · Besteckkasten  
Cutlery tray · Tabuleiro de talheres

Ref	€	cm	h (cm)	U.Venta
67952	24,70	15x22	11	1



**Bandeja mármol white melamina**

Plateau en marbre mélaminé blanc  
Marmortablett weißes Melamin  
White melamine marble tray  
Tabuleiro de mármore em melamina

Ref	€	cm	U.Venta
63076	21,20	32,5x17,5 (GN 1/3)	1
63077	34,90	32,5x26,5 (GN 1/2)	1
63079	31,20	53x16,5 (GN 2/4)	1
63078	67,60	53x32,5 (GN 1/1)	1



**Bandeja mármol black melamina**

Plateau en mélamine noire  
Schwarzes Melamin-Marmortablett  
Black melamine marble tray  
Tabuleiro de mármore em melamina

Ref	€	cm	U.Venta
63096	21,20	32,5x17,6 (GN 1/3)	1
63097	34,90	32,5x26,5 (GN 1/2)	1
63099	31,20	53x16,5 (GN 2/4)	1
63098	67,60	53x32,5 (GN 1/1)	1



**Bandeja pizarra**

Plateau en ardoise  
Schiefertablett  
Slate tray  
Bandeja de ardósia

Ref	€	cm	U.Venta
61223	4,60	32,5x17,6 (GN 1/3)	1
61222	6,90	32,5x26,5 (GN 1/2)	1
61224	7,80	53x16,5 (GN 2/4)	1
61221	15,60	53x32,5 (GN 1/1)	1

# Cuberteros

INOX  
Dishwasher



## Vaso inox cubertería

Panier pour porte couvert · Besteckköcher  
St. steel cutlery cylinder · Copos p/talheres inox



Ref	€	h(cm)	U.Venta
33125	7,80	14	6

- Ideal para organizar y guardar los cubiertos y utensilios de la cocina.
- No se deforma con el peso de los cubiertos.
- Cómodo de transportar gracias a sus asas laterales.
- Apilable.

- Ideal to organize and save the cutlery and kitchen utensils.
- It does not deform with the weight of the cutlery.
- Comfortable to transport thanks to your lateral handles.
- Stackable.



PP  
Polypropylene



## Cubertero GN 1/2

Range-couverts · Besteckkasten  
Cutlery holder · Bandeja para talheres

Ref	€	cm	h(cm)	U.Venta
33121	11,50	52,5x32	9,5	1

A



B



C



## Soporte para cubiertos con vasos

Porte couverts avec paniers · Besteckbehälter  
Cutlery holder w/cylinder · Sup. talheres com copos

Ref	€	cm	Orificios	U.Venta
33124	87,00	29x22x26	4	1
33126	106,90	29x22x38	6	1

A



B



## Contenedor cubiertos

Panier à couverts · Besteckköcher  
Cutlery holder · Copos para talheres

Ref	€	Ø (cm)	h(cm)	L	U.Venta
A 62962	21,60	12	13,6	1,40	1
B 62963	25,10	12	18,7	2,00	1

- Recipiente para cubiertos en color negro de polipropileno.
- Ideal para organizar y guardar los cubiertos y utensilios de la cocina.
- Apilable.
- Récipient de couverts en polypropylène noir.
- Idéal pour organiser et sauver les couverts et les ustensiles de cuisine.
- Empilable.
- Black polypropylene cutlery container.
- Ideal to organize and save the cutlery and kitchen utensils.
- Stackable.

PP  
Polypropylene



## Cubertero Ratán

Range-couverts · Besteckkasten  
Cutlery holder · Bandeja para talheres

Ref	€	cm	h(cm)	Compartimentos	U.Venta
A 63484	8,60	27x10	4,5	1	1
B 63485	8,60	Ø12	15,0	1	1
C 63491	76,80	53x32,5	9,0	4	1

# Paneras y Fruteros

INOX



## Frutero - Panera inox

Paniere à fruit et à pain · Brot-/Obstschale  
Fruits and bread basket · Fruteiro-Cesto

Ref	€	Ø (cm)	U.Venta
61821	7,70	20	1
61823	11,60	24	1

A

B

C

D



## Panera kraft

Boîte à pain · Brotkasten  
Bread basket · Caixa para guardar pão

Ref	€	cm	h max (cm)	h min (cm)	U.Venta
A 63476	13,80	10x10	25	8	1
B 63477	14,70	12x12	25	12	1
C 63478	16,60	15x15	25	12	1
D 63479	19,20	20x20	33	12	1

A

B

C

D



## Panera Tex

Boîte à pain · Brotkasten  
Bread basket · Caixa para guardar pão

Ref	€	cm	h max (cm)	h min (cm)	U.Venta
A 63486	13,80	10x10	25	8	1
B 63487	14,70	12x12	25	12	1
C 63488	16,60	15x15	25	12	1
D 63489	19,20	20x20	33	12	1



- Tapa fabricada en madera de caucho con orificios de ventilación para una óptima circulación del aire.
- 2 en 1: la tapa de madera de caucho se puede utilizar como tabla de cortar.

- Cover made of rubber wood with ventilation holes for optimal air circulation.
- Designed to conserve bread and other always fresh products.
- 2 in 1: The rubber wood lid can be used as a cutting table.

A



B



RUBBER WOOD

## Panera nórdica

Boîte à pain · Brotkasten  
Bread basket · Caixa para guardar pão

Ref	€	cm	h(cm)	U.Venta
A 62868	39,60	30x18	12,5	1
B 62869	43,00	42x22,5	12,5	1



- Fabricada en fibra virgen natural.
- Material ecológico y respetuoso con el medio ambiente.
- Lavable, resistente y duradera.
- Diseñada y fabricada en España.
- Hecha a mano.
- Tacto agradable y suave, similar a la piel. Espesor 0,55 mm.

- Fabriqué en fibre vierge naturelle.
- Matériel écologique et environnemental.
- Lavable, résistant et durable.
- Conçu et fabriqué en Espagne.
- Fait main.
- Un toucher agréable et doux, similaire à la peau. 0,55 mm d'épaisseur.

- Manufactured in natural virgin fiber.
- Ecological and environmental material.
- Washable, resistant and lasting.
- Designed and manufactured in Spain.
- Handmade.
- Nice and soft touch, similar to the skin. 0.55 mm thickness.



**Estructura de refuerzo de acero inoxidable**  
Stainless steel reinforcement structure

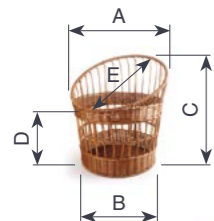

- Cesta para pan fabricada en polipropileno. Diseñada para uso intensivo.
- Estructura de refuerzo de acero inoxidable. Parte trasera más alta que proporciona suficiente apoyo para panes largos.
- Material con aspecto de mimbre muy resistente, libre de BPA.
- Elaborada a mano. Práctica e higiénica. Acabado en mate.
- Ideal para almacenar y exponer panes.
- Apilable.

- Panier à pain fabriqué en polypropylène. Conçu pour une utilisation intensive.
- Structure d'armature en acier inoxydable. L'arrière le plus élevé qui fournit un soutien suicide aux pains longs.
- Matériau très résistant en osier, sans BPA.
- Fait main. Pratique et hygiénique. Finition mate.
- Idéal pour stocker et exposer le pain.
- Empilable.

- Bread basket manufactured in polypropylene. Designed for intensive use.
- Stainless steel reinforcement structure. Highest rear that provides suicide support for long breads.
- Very resistant wicker-like material, BPA free.
- Handmade. Practice and hygienic. Matte finish.
- Ideal to store and expose bread.
- Stackable.

### Cesta baguette

Corbeille · Brotkorb  
Basket · Cesta

	Ref	€	A (cm)	B (cm)	C (cm)	D (cm)	E (cm)	U.Venta
<b>A</b>	63492	64,40	32,0	28,5	42,0	25,0	36,5	1
<b>B</b>	63493	64,40	32,0	28,5	42,0	25,0	36,5	1



### Cesta de pan redonda

Corbeille a pain ronde · Brotkorb, rund  
Round bread basket · Cesta de pão redonda

	Ref	€	Ø (cm)	h(cm)	U.Venta
<b>A</b>	63471	7,90	19	8	1
	63472	8,80	21	8	1
	63473	9,40	23	8	1
	63474	10,10	28	8	1
<b>B</b>	63871	8,00	19	8	1
	63872	8,80	21	8	1
	63873	9,40	23	8	1
	63874	10,20	26	8	1



### Cesta de pan

Corbeille a pain · Brotkorb  
Bread basket · Cesta de pão

	Ref	€	Ø (cm)	h (cm)	U.Venta
<b>A</b>	63494	30,80	35	20	1
<b>B</b>	63894	30,30	35	20	1

### Cesta de pan oval

Corbeille a pain ovale · Brotkorb, Oval  
Oval bread basket · Cesta de pão oval

	Ref	€	cm	h(cm)	U.Venta
<b>A</b>	63480	7,20	19x14	8,0	1
	63481	8,50	24x17	8,0	1
	63482	10,40	28x16	8,5	1
<b>B</b>	63880	7,20	19x14	8,0	1
	63881	8,40	24x17	8,0	1
	63882	10,40	28x16	8,5	1



### Cesta de pan cuadrada

Corbeille a pain carré · Brotkorb, vierekigl  
Square bread basket · Cesta de pão quadrada

	Ref	€	cm	h (cm)	U.Venta
<b>A</b>	63490	35,20	53x33,5	9	1
<b>B</b>	63890	34,90	53x33,5	9	1



- Diseño transpirable.
- Versátil: ideal para fruta, verdura, tarros de conservas, frutos secos, huevos, etc.

- The breathable,
- Versatile: perfect for fruit, vegetables, canning jars, etc.

Medidas · Sizes  
19,5x17,5x7 cm

Medidas · Sizes  
29x18x8 cm

FE  
Iron

### Frutero Dual SQ

Corbeille à fruits · Obstkorb  
Fruit basket · Fruteira

Ref	€	cm	h(cm)	U.Venta
61124	19,30	29x18,5	33,5	4

Madera contrachapada color haya  
Plywood beech color

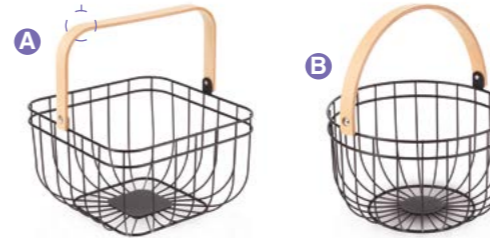

FE  
Iron

### Frutero varilla mango

Corbeille à fruits · Obstschale aus Gitterstäben  
Square fruit bowl · Cesto de metal para fruta

	Ref	€	h (cm)	Diámetro varilla (mm)	U.Venta
<b>A</b>	61137	35,30	28	4	1
<b>B</b>	61138	35,30	29	4	1

Ideales para almacenar fruta, pan, verduras, huevos, etc.  
Can be used for storing fruit, bread, vegetables, eggs, etc.

FE  
Iron

### Frutero varillas

Corbeille à fruits · Obstschale aus Gitterstäben  
Square fruit bowl · Cesto de metal para fruta

	Ref	€	Ø (cm)	h (cm)	Diámetro varilla (mm)	U.Venta
<b>A</b>	61126	23,50	23,5	25,5	4	2
<b>B</b>	61127	21,40	27,0	14,0	4	1
<b>C</b>	61128	22,60	34,0	9,5	4	1

### Frutero varillas Dual

Corbeille à fruits · Obstschale aus Gitterstäben  
Rod fruit bowl · Cesto de metal para fruta

Ref	€	Diámetro varilla (mm)	Ø superior (cm)	Ø inferior (cm)	h(cm)	U.Venta
61140	54,90	4	Ø40x10	Ø24x10	63	1

Madera aglomerada  
Agglomerate wood



FE  
Iron

### Frutero varillas redondo bajo

Corbeille à fruits ronde basse · Obstschale aus Gitterstäben  
Round low rod fruit bowl · Cesto de metal para fruta redondo baixo

Ref	€	Diámetro varilla (mm)	Ø superior (cm)	Base (cm)	h(cm)	U.Venta
61139	40,80	4	39	31,3	7,6	1

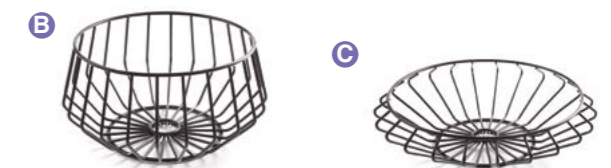

# Tostadoras Buffet

INOX 18/10 CE 



## Tostador Continuo

Grille-painl · Toaster  
Toaster · Torradeira

Ref	€	W	Velocidad	Medidas	U.Venta
69065	858,70	1340	0,46-0,73m/mi	42x28,5x42 cm	1
69066	990,40	2240	0,46-0,73m/mi	41,6x36,8x29,5 cm	1



## Tostador Horizontal

Grille-painl · Toaster  
Toaster · Torradeira

Ref	€	W	Tiempo	Número de lámparas	Grill	Medidas	U.Venta
A 69172	364,00	2400	0-15 min	6	40x24 cm	50x29x28cm	1
B 69173	430,20	3600	0-15 min	9	40x24 cm	50x29x37,5cm	1



## Tostadora Buffet

Grille-painl · Toaster  
Toaster · Torradeira

Ref	€	W	Ranuras	Medidas	U.Venta
A 69294	237,00	1800 W	4	30x24,5x21,5 cm	1
B 69296	314,80	2500 W	6	43,5x26x22 cm	1

# Fuentes de Chocolate

INOX 18/10 CE 



## Fuentes Chocolate

Fontaine chocolat · Schokoladen Fontäne  
Chocolate fountain · Fonte chocolate

Ref	€	W	Temperatura	Capacidad	U.Venta
A 69318	61,70	35	40°C -50°C	0,5L	1
B 69319	105,00	80	40°C -50°C	1,8L	1

- Fabricada en acero inoxidable 18/10 de gran calidad.
- Crea una cascada de chocolate fundido y lo mantiene caliente para bañar alimentos.
- Ideal para buffet, hoteles, restaurantes, estas y celebraciones.
- Torre de 18 cm de tres niveles.
- Interruptor de calentamiento independiente.
- Base con apoyos antideslizantes.
- Desmontable.

- Fabriqué en acier inoxydable 18/10 de haute qualité.
- Créez une cascade de chocolat coulée et gardez-la chaude pour baigner les aliments.
- Idéal pour le buffet, les hôtels, les restaurants, ceux-ci et les célébrations.
- Tour de 18 cm de trois niveaux.
- Interrupteur de chauffage indépendant.
- Base avec support non glissé.
- Amovible.

- Made of stainless steel 18/10 of high quality.
- Create a cast chocolate cascade and keep it hot to bathe food.
- Ideal for buffet, hotels, restaurants, these and celebrations.
- 18 cm tower of three levels.
- Independent heating switch.
- Base with non-slip support.
- Removable.

# Placa Vitrocerámica Energy

INOX CE 

- Placa vitrocerámica rápida, eficaz, segura, fiable y de gran capacidad de calentamiento.
- Su diseño portátil y compacto resulta ideal para su uso en cualquier lugar.
- Área de cocción de 10 cm / 20 cm de diámetro.
- Botones táctiles, intuitivos y fáciles de utilizar con un toque suave.
- Indicadores luminosos.
- Dispone de función de bloqueo de seguridad para niños.
- Regulable en potencia y temperatura.
- Temporizador de 240 minutos con avisador acústico y auto desconexión.

- Plaque de capacité rapide, efficace, sûre, fiable et de chauffage.
- Sa conception portable et compacte est idéale pour une utilisation n'importe où.
- Zone de cuisson de 10 cm / 20 cm de diamètre.
- Boutons tactiles, intuitifs et faciles à utiliser avec une touche douce.
- Indicateurs lumineux.
- Il a une fonction de verrouillage de sécurité des enfants.
- Réglable en puissance et en température.
- Timer de 240 minutes avec avertissement acoustique et auto-disconnection.

- Fast, effective, safe, reliable and heating capacity plate.
- Its portable and compact design is ideal for use anywhere.
- Cooking area of 10 cm / 20 cm in diameter.
- Tactile buttons, intuitive and easy to use with a soft touch.
- Luminous indicators.
- It has children's security lock function.
- Adjustable in power and temperature.
- 240 minutes timer with acoustic warning and self-disconnection.

Superficie de calentamiento  
Heating surface

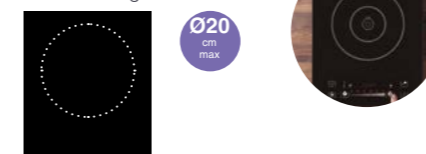

## Placa Vitrocerámica Energy

Plaque vitrocéramique · Keramikkochfeld  
Ceramic hob · Placa vitrocerámica

Ref	€	W	Niveles potencia	Tiempo	Superficie placa	Medidas	U.Venta
69232	115,40	2000	8	240 minutos	Ø10-20 cm	39x32x5,5 cm	1



# Placas de inducción



- Placas de inducción rápidas, eficaces, seguras, fiables y de gran capacidad de calentamiento.
- Sus diseños portátiles y compactos resultan ideales para su uso en cualquier lugar.
- Botones táctiles, intuitivos y fáciles de utilizar con un toque suave.
- Dispone de función de bloqueo de seguridad para niños.
- 40% ahorro de tiempo y energía respecto a otras placas convencionales.

- Plaque à induction rapide, efficace, sûre, fiable et d'une grande capacité de chauffe.
- Sa conception portable et compacte est idéale pour une utilisation n'importe où.
- Boutons tactiles, intuitifs et faciles à utiliser avec un toucher doux.
- Dispose d'une fonction de blocage de sécurité pour les enfants.
- 40% de gain de temps et d'économies d'énergies par rapport à d'autres plaques conventionnelles

- Fast, efficient, safe, reliable induction hob with high heating capacity.
- Its portable and compact design is ideal for use anywhere.
- Intuitive and easy to use soft touch buttons.
- Includes a child safety lock function.
- 40% saving in time and energy compared to other conventional hobs.

Superficie de calentamiento Heating surface

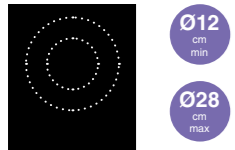

## Placa de inducción Profesional Chef

Plaque induction professionnelle · Profi-Induktionsplatte  
Professional induction cooktop · Placa de indução profissional

Ref	€	W	Niveles potencia	Tiempo	Medidas	U.Venta
69132	443,20	3500	17	180 min	34x43x12 cm	1

Superficie de calentamiento Heating surface



## Placa de inducción profesional Easy

Plaque induction professionnelle · Profi-Induktionsplatte  
Professional induction cooktop · Placa de indução profissional

Ref	€	W	Niveles potencia	Medidas	U.Venta
69362	380,20	3500	10	34x44,5x12,5 cm	1

Superficie de calentamiento Heating surface



## Placa de inducción profesional Roca

Plaque induction professionnelle · Profi-Induktionsplatte  
Professional induction cooktop · Placa de indução profissional

Ref	€	W	Niveles potencia	Tiempo	Medidas	U.Venta
69337	374,70	2700	10	180 min	30x39x10 cm	1

Superficie de calentamiento Heating surface



## Placa de inducción Pro

Table de cuisine à induction · Induktionskochfeld  
Induction cooker · Placa de indução

Ref	€	W	Niveles potencia	Medidas	U.Venta
69371	343,00	3500	10	36x38x12,5 cm	1

Superficie de calentamiento Heating surface



## Placa de inducción Slim

Table de cuisine à Induktion · Induktionskochfeld  
Induction cooker · Placa de indução

Ref	€	W	Niveles potencia	Tiempo	Medidas	U.Venta
69332	162,70	2000	8	180 min	30x37x4,5 cm	1

Superficie de calentamiento Heating surface



Posibilidad de encastrar Encastrable option

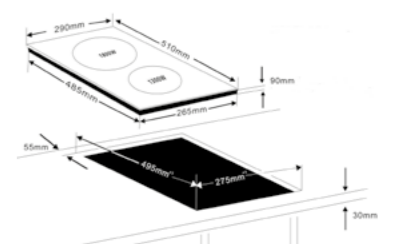

## Placa de inducción Dual Vertical

Plaque induction double · Induktionskochfeld doppelt  
Double induction cooktop · Placa de indução dupla

Ref	€	W	Niveles potencia	Tiempo	Medidas	U.Venta
69033	469,70	1800+1300	8	0-99 min	29x51x9 cm	1

Superficie de calentamiento Heating surface



Posibilidad de encastrar Encastrable option

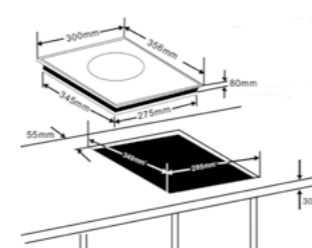

## Placa de inducción Expert

Table de cuisine à induction · Induktionskochfeld  
Induction cooker · Placa de indução

Ref	€	W	Niveles potencia	Tiempo	Medidas	U.Venta
69032	286,90	2000	6	0-180 min	31x36x7,5 cm	1

Superficie de calentamiento Heating surface



Posibilidad de encastrar Encastrable option

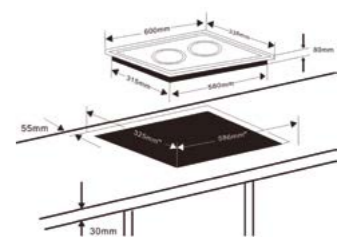

## Placa de inducción Dual Horizontal

Plaque induction · Induktionskochfeld doppelt  
Induction cooktop · Placa de indução

Ref	€	W	Niveles potencia	Tiempo	Medidas	U.Venta
69333	277,60	2000+1500	7	0 - 180 min	60 x 34 x 7,5 cm	1

**Inox** Placa cerámica: Ø26 cm  
Ceramic plate: Ø26 cm



INOX

### Placa de inducción Wok Profesional

Plaque à induction wok professionnelle · Induktionskochplatte wok profesional  
Induction cooktop wok professional · Placa indução wok profissional

Ref	€	W	Tiempo	Medidas	U.Venta
69138	<b>460,20</b>	3500 W	180 min	34x44,5x12,5 cm	1

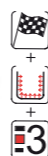

### Wok Trimetal

Wok Trimetal · Wok, Trimetal  
Trimetal wok · Wok Trimetal

Ref	€	Ø (cm)	h(cm)	e (mm)	L
53836	<b>179,20</b>	36	10,5 cm	2,7 mm	5,50

## Placas calentamiento

INOX 18/10  

- Una solución perfecta para profesionales de la hostelería, buffet, eventos, catering, ferias, etc.
- Ideal para mantener los alimentos calientes antes de servirlos en la mesa a la temperatura perfecta.
- Termostato regulable en temperatura.
- Atención: NO cocinar sobre la misma placa.

- Une solution parfaite pour l'hospitalité, les professionnels du buffet, les événements, la restauration, les foires, etc.
- Idéal pour garder les aliments chauds avant de les servir à la table à la température parfaite.
- Thermostat réglable à température.
- ATTENTION: Ne cuisinez pas dans la même assiette.

- A perfect solution for hospitality, buffet professionals, events, catering, fairs, etc.
- Ideal to keep hot food before serving them at the table at the perfect temperature.
- Adjustable thermostat in temperature.
- Attention: Do not cook on the same plate.



### Calentador Buffet 3xGN 1/3

Chauffe · Warmer  
Warmer · Aquecedor

Ref	€	W	Superficie placa	Contenedor	Medidas	U.Venta
69445	<b>102,40</b>	300	53x36 cm	GN 1/3 (x3)	65x38x15,5 cm	1



### Placa calentamiento

Plaque pour Chauffante · Warmhalteplatte  
Warming Plate · Placa aquecimiento

Ref	€	W	Superficie placa	Medidas	U.Venta
69045	<b>95,00</b>	300	53x36 cm	65x38x6,2 cm	1



### Placa calentamiento Vitrocerámica

Plaque vitrocéramique chaleur · Glaskeramikerheizplatte  
Hob heating plate · Placa aquecimiento vitrocerámica

Ref	€	W	Superficie placa	Temperatura	U.Venta
69145	<b>210,30</b>	230	55x36,5 cm	60-105°C	1



### Placa calentamiento Vitro Slim

Plaque vitrocéramique chaleur · Glaskeramikerheizplatte  
Hob heating plate · Placa aquecimiento vitrocerámica

Ref	€	W	Superficie placa	Temperatura	U.Venta
69446	<b>104,10</b>	230	38x45 cm	60-105°C	1

## Calentador Buffet

INOX  

- Ideal para grandes cocinas, buffet, catering o comedores.
- Mantiene los platos a temperatura perfecta durante un tiempo prolongado.
- Estructura de acero inoxidable de alta calidad y resistente.
- Placa calentadora de acero inoxidable con regulación de temperatura entre 40°C - 90°C.
- Lámparas halógenas para garantizar una temperatura homogénea con regulación independiente para cada una de ellas.
- Pantalla protectora de plexiglas altamente resistente.

- Idéal pour les grandes cuisines, buffet, restauration ou salle à manger.
- Gardez la vaisselle à température parfaite pendant longtemps.
- Structure en acier inoxydable de haute qualité et résistante.
- Réfonce en acier inoxydable avec régulation de la température entre 40 ° C à 90 ° C.
- Lampes halogènes pour garantir une température homogène avec une régulation indépendante pour chacun d'eux.
- Écran de protection en plexiglas très résistant.

- Ideal for large kitchens, buffet, catering or dining rooms.
- Keep the dishes at perfect temperature for a long time.
- High quality and resistant stainless steel structure.
- Stainless steel heater with temperature regulation between 40°C - 90°C.
- Halogen lamps to guarantee a homogeneous temperature with independent regulation for each of them.
- Highly resistant plexiglass protective screen.



Incluye bombillas infrarrojos (Ref.: R69061A)  
Includes infrared heating bulbs

**A** Dual

**B** Triple



### Calentador Buffet

Plaque électrique · Warmhalteplatte  
Electric warming plate · Placa aquecimiento eléctrico

	Ref	€	W (placa)	W (lámpara)	Superficie placa	Medidas	U.Venta
<b>A</b>	69562	<b>533,40</b>	500	2x250W	71x50 cm	78x53x70 cm	1
<b>B</b>	69563	<b>702,80</b>	650	3x250W	99x50 cm	107x53x70 cm	1

# Lámparas de calentamiento

AL Aluminium

- Lámpara calentamiento infrarrojos doble para mantener calientes los platos, las cubetas, etc.
- Diseñada para uso profesional en restauración, buffet, etc.
- Calentamiento por infrarrojos.
- Mantiene calientes los platos, cubetas, chafing dish, etc.
- Altura regulable.
- Incluye dos bombillas.
- Vida útil de la bombilla (2000 horas para uso continuo y 5000 horas para uso intermitente).
- Se aconseja mantener la lámpara a 50 - 60 cm de distancia de los platos.

- Lampe à réchauffement à double infrarouge pour garder la vaisselle, les seaux, etc. chauds, etc.
- Conçu pour une utilisation professionnelle dans la restauration, le buffet, etc.
- Réchauffement infrarouge.
- Gardez la vaisselle, les cuvetas, le frottement, etc.
- Hauteur réglable.
- Comprend deux ampoules.
- Durée de vie de l'ampoule (2000 heures pour une utilisation continue et 5000 heures pour une utilisation intermittent).
- Il est conseillé de garder la lampe à 50 à 60 cm des plats.

- Double infrared warming lamp to keep the dishes, buckets, etc. hot, etc.
- Designed for professional use in restoration, buffet, etc.
- Infrared warming.
- Keep the dishes, cuvetas, chafing dish, etc.
- Adjustable height.
- Includes two bulbs.
- Life of the bulb (2000 hours for continuous use and 5000 hours for intermittent use).
- It is advisable to keep the lamp 50 - 60 cm away from the dishes.

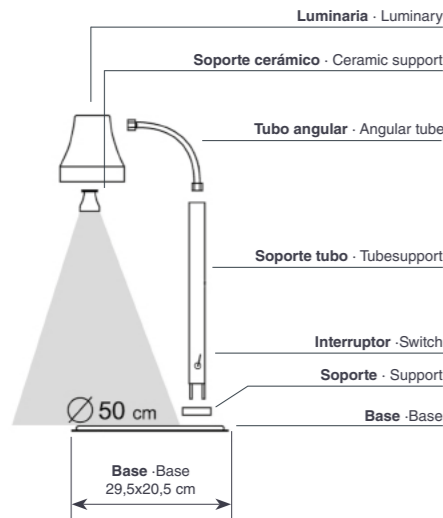

**Bombilla infrarrojos**  
Ampoule infrarouge · Infrarot Glühbirne  
Infrared heating bulb · Lampada infravermelho

Ref	€	W	U. Venta
R69061A	10,10	275	1



**Lámpara calentamiento infrarrojos**  
Lampe de chauffage infrarouge · Infrarot Wärmelampe  
Infrared heating lamp · Lampara calor infravermelho

	Ref	€	W	Medidas	h(cm)	U.Venta
A	69361	108,00	275	34x33cm	71	1
B	69061	149,40	550	36x45cm	75	1



INOX 18/10

**Lámpara calentamiento infrarrojos Inox**  
Lampe de chauffage infrarouge · Infrarot Wärmelampe  
Infrared heating lamp · Lampara calor infravermelho

	Ref	€	W	Medidas	h(cm)	U.Venta
A	69263	486,40	275	31x23cm	79	1
B	69264	632,30	550	36x36cm	76	1

# Lámparas de calentamiento extensibles

AL Aluminium

- Para uso profesional en hostelería.
- Mantiene calientes los platos.
- Calentamiento por infrarrojos.
- Se aconseja mantener la lámpara a 50 - 60 cm de distancia de los platos.
- Incluye bombilla para todas nuestras lámparas de calentamiento.

- Pour un usage professionnel dans la restauration.
- Maintient les plats au chaud.
- Chauffage infrarouge.
- Il est conseillé d'éloigner la lampe de 50 à 60 cm de distance de la vaisselle.
- Comprend une ampoule pour toutes nos lampes chauffantes.

- For professional catering use.
- Keeps the dishes warm.
- Infrared heating.
- It is recommended that the lamp is kept at a distance of 50-60cm from the plates.
- Bulb for all our heating lamps.



**Incluye bombillas infrarrojos (Ref.: R69061A)**  
Includes infrared heating bulbs



**Lámparas de calentamiento extensibles**

Lampe de chauffage câble extensible · Infrarot Wärmelampe Kabel ausziehbar  
Infrared heating lamp extensible · Lampara calor infravermelho cabo extensível

	Ref	€	W	U.Venta	
A	69266	130,20	275	1	Lijado · Sanding
B	69365	149,60	275	1	Cromado · Chrome
C	69367	149,60	275	1	Cobre · Copper
D	69359	141,20	275	1	Negra · Black

**Lámparas de calentamiento extensibles cónica**

Lampe chauffante extensible conique · Wärmelampe Kabel ausziehbar, konisch  
Conical heating lamp extensible · Lampada de aquecimento ext. cônica

	Ref	€	W	U.Venta	
E	69564	134,80	275	1	Lijado · Sanding
F	69566	161,80	275	1	Cromado · Chrome
G	69565	164,60	275	1	Cobre · Copper
H	69576	151,00	275	1	Negra · Black

# Vitrinas



- Vitrina neutra construida íntegramente en cristal y base de acero inoxidable.
- Diseñada para presentar y exponer sobre la barra / mostrador.
- Superficie superior curvada para una visión panorámica.
- Estante intermedio de cristal templado.
- Puerta trasera abatible.
- 4 pies de goma que garantizan máxima estabilidad.

- Vitrine neutre construite entièrement dans une base en verre et en acier inoxydable.
- Conçu pour présenter et exposer sur la barre / comptoir.
- Surface supérieure incurvée pour une vue panoramique.
- Étagère en verre trempé intermédiaire.
- Porte arrière pliante.
- 4 pieds en caoutchouc qui garantissent une stabilité maximale.

- Neutral showcase built entirely in glass and stainless steel base.
- Designed to present and expose on the bar / counter.
- Curved upper surface for a panoramic view.
- Intermediate tempered glass shelf.
- Folding rear door.
- 4 rubber feet that guarantee maximum stability.

CRISTAL INOX  
Glass

## Vitrina neutra

Vitrine neutre · Einfache vitrine  
Clear countertop display case · Vitrina neutra

Ref	€	Capacidad	h(cm)	Medidas	U.Venta
69601	293,10	45L	37	56x37,6x37 cm	1

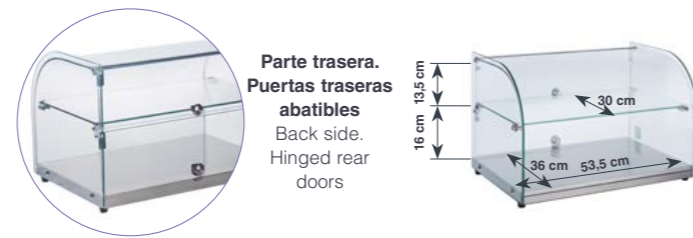

- Vitrina térmica fabricada en acero inoxidable y cristal.
- Diseñada para conservar, presentar y exponer sobre la barra / mostrador.
- Puerta trasera abatible.
- Superficie superior inclinada para una visión panorámica.
- Recipiente de agua extraíble que aporta humedad en la cámara.
- Termostato de control de temperatura regulable: 30-90°C.
- Bandeja de rejilla extraíble que facilita el lujo del calor.

- Vitrine thermique fabriquée en acier inoxydable et en verre.
- Conçu pour conserver, présenter et exposer sur la barre / comptoir.
- Porte arrière pliante.
- Supérieur submergé pour une vue panoramique.
- Récipient d'eau amovible qui apporte l'humidité dans la chambre.
- Thermostat de commande de température réglable: 30-90°C.
- Plateau de grille amovible qui facilite le luxe de la chaleur.

- Thermal showcase manufactured in stainless steel and glass.
- Designed to conserve, present and expose on the bar / counter.
- Folding rear door.
- Superior overwhelmed for a panoramic view.
- Removable water container that brings moisture in the chamber.
- Adjustable temperature control thermostat: 30-90°C.
- Removable grid tray that facilitates the luxury of heat.

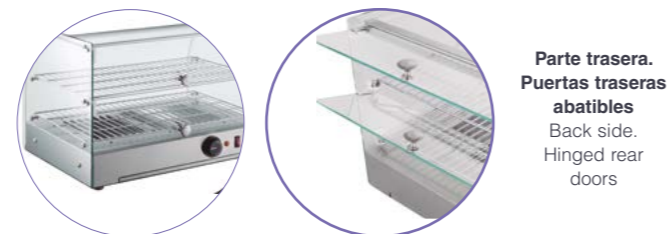

CRISTAL INOX  
Glass

## Vitrina térmica

Vitrine thermique · Warmhaltevitrine  
Thermal display case · Vitrina tèrmica

Ref	€	W	Capacidad	Temperatura	Protección	Medidas	U.Venta
69604	592,80	800	45L	30°C-90°C	IPX4	55,5x37,5x37 cm	1



4  
Cubetas  
Containers



6  
Cubetas  
Containers

CRISTAL INOX  
Glass

## Vitrina térmica con cubetas

Vitrine thermique · Warmhaltevitrine  
Thermal display case · Vitrina tèrmica

	Ref	€	W	Capacidad	Temperatura	Protección	Medidas	U.Venta
A	69602	653,60	500	4x GN1/3	30°C-90°C	IPX4	77,5x42x33,5 cm	1
B	69603	751,40	800	6x GN 1/3	30°C-90°C	IPX4	113x42x33,5 cm	1

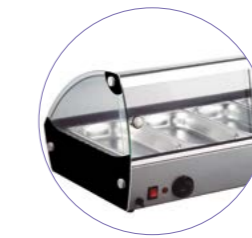

Parte trasera. Puertas traseras correderas.  
4 / 6 cubetas gastronorm 1/3 incluidas  
Back side. Sliding rear doors. 4/6 Gastronorm 1/3 trays included

IPX4

- Vitrina refrigerada construida íntegramente en cristal y acero inoxidable.
- Diseñada para conservar, presentar y exponer sobre la barra / mostrador.
- Puertas correderas para una accesibilidad total.
- Superficie superior inclinada para una visión panorámica.
- Sistema de enfriamiento por compresor. Función Defrost.
- Termostato de control de temperatura regulable: 2-12°C.
- Sist. de iluminación LED en la cámara interior y display de control de mandos.

- Vitrine réfrigérée construite entièrement en verre et en acier inoxydable.
- Conçu pour conserver, présenter et exposer sur la barre / comptoir.
- Portes coulissantes pour l'accessibilité totale.
- Surface supérieure inclinée pour une vue panoramique.
- Système de refroidissement du compresseur. Fonction de dégivrage.
- Thermostat de commande de température réglable: 2-12°C.
- Sist. d'éclairage LED dans la chambre intérieure et le contrôle des commandes.

- Refrigerated showcase built entirely in glass and stainless steel.
- Designed to conserve, present and expose on the bar / counter.
- Sliding doors for total accessibility.
- Inclined upper surface for a panoramic view.
- Compressor cooling system. Defrost function.
- Adjustable temperature control thermostat: 2-12°C.
- Sist. of LED lighting in the inner chamber and control of controls.



CRISTAL INOX  
Glass

## Vitrina refrigerada

Vitrine réfrigérée · Kühlvitrine  
Refrigerated display case · Vitrina refrigerada

Ref	€	W	Capacidad	Temperatura	Refrigerante	Medidas	U.Venta
69607	1113,60	105	40L	2-12°C	R600a	68x58x34 cm	1



Parte trasera  
Back side



A

4  
Cubetas  
Containers

B

6  
Cubetas  
Containers

- Vitrina refrigerada construida íntegramente en cristal y acero inoxidable.
- Diseñada para conservar, presentar y exponer sobre la barra / mostrador.
- Puertas correderas para una accesibilidad total.
- Superficie superior curvada para una visión panorámica.
- Sistema de enfriamiento por compresor.
- Cubetas gastronorm 1/3 incluidas.
- Termostato de control de temperatura regulable: 0-12°C.
- Sistema de iluminación LED en la cámara interior y display de control de mandos.

- Vitrine réfrigérée construite entièrement en verre et en acier inoxydable.
- Conçu pour conserver, présenter et exposer sur la barre / comptoir.
- Portes coulissantes pour l'accessibilité totale.
- Surface supérieure incurvée pour une vue panoramique.
- Système de refroidissement du compresseur.
- Cubetes Gastronorm 1/3 inclus.
- Thermostat de commande de température réglable: 0-12°C.
- Système d'éclairage LED dans l'écran de commande de la chambre intérieure et de la commande.

- Refrigerated showcase built entirely in glass and stainless steel.
- Designed to conserve, present and expose on the bar / counter.
- Sliding doors for total accessibility.
- Curved upper surface for a panoramic view.
- Compressor cooling system.
- Gastronorm 1/3 trays included.
- Adjustable temperature control thermostat: 0-12°C.
- LED lighting system in the inner chamber and control control display.



#### Control de temperatura regulable

Temperature control thermostat

Puertas traseras correderas  
Sliding rear doors

INOX

CRISTAL  
Glass

#### Vitrina refrigerada con cubetas

Vitrine réfrigérée · Kühlvitrine

Refrigerated display case · Vitrina refrigerada

	Ref	€	W	Capacidad	Temperatura	Refrigerante	Medidas	U.Venta
A	69605	1270,50	160	4x GN 1/3	0°C-12°C	R600a	112,1x45x33 cm	1
B	69606	1408,60	160	6x GN 1/3	0°C-12°C	R600a	148,3x45x33 cm	1

#### 69602

Combinaciones posibles  
Possible combinations

GN 2/3	GN 2/3
--------	--------

GN 1/3	GN 1/3	GN 1/3	GN 1/3
--------	--------	--------	--------

#### 69603

Combinaciones posibles  
Possible combinations

GN 2/3	GN 2/3	GN 2/3
--------	--------	--------

GN 1/2	GN 1/2	GN 1/2	GN 1/2
--------	--------	--------	--------

GN 1/3	GN 1/3	GN 1/3	GN 1/3	GN 1/3	GN 1/3
--------	--------	--------	--------	--------	--------

# Gastronorm

## Gastronorm

# Soporte para cubetas

INOX 18/10

## COMPATIBILIDAD DE CUBETAS CON LOS SOPORTES CONTAINERS COMPATIBILITY WITH SUPPORTS

	INOX 18/10	INOX	PC	PP	MELAMINA
	X	X			
	✓	✓	✓	X	✓
	✓	✓	✓		✓
	X	X			X
	✓	✓	✓	X	✓
	✓	✓	✓	✓	✓
	X	X	✓	X	X
	✓	✓	✓	✓	✓
	✓	✓	✓	✓	✓

- Fabricado en acero inoxidable 18/10.
- Organiza los alimentos y ahorra tiempo en la preparación de platos.
- Ideal para cocinas profesionales, restaurantes, buffet, autoservicios, etc.
- Travesaños verticales amovibles diseñados para combinar cubetas de distintos tamaños de hasta 200 mm de profundidad.
- Pies de goma antideslizantes que garantizan una óptima estabilidad.

- Fabriqué en acier inoxydable 18/10.
- Organisez les aliments et gagnez du temps lors de la préparation de vos plats.
- Idéal pour les cuisines professionnelles, les restaurants, les buffets, les self-services, etc.
- Barres transversales verticales amovibles conçues pour combiner des bacs de différentes tailles de 200 mm de profondeur.
- Pieds en caoutchouc antidérapants qui garantissent une stabilité optimale.

- Made of 18/10 stainless steel.
- Organize food and save time while making dishes.
- Perfect for professional chefs, restaurants, buffets, self-service, etc.
- It has removable vertical cross pieces designed to combine trays of different sizes to 200 mm deep.
- The non-slip rubber feet ensure optimum stability.

### Diversas combinaciones posibles Several possible combinations

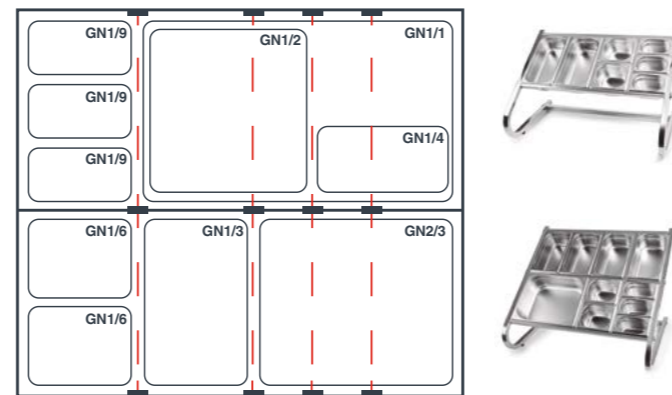

INOX 18/10

## Soporte para cubetas

Support de bacs Gastronom · Unterstützung für Gastronom-Küvetten  
Gastronom cuvette support · Suporte de cubeta Gastronom

	Ref	€	cm	U.Venta
A	66245	84,10	78x49x46	1
B	66246	108,30	78x78x63	1

**Soporte simple** · Simple support  
**Soporte doble** · Double support

# Cubetas Inox 18/10 - Inox

INOX 18/10



- Fabricadas en acero inoxidable y acero inoxidable 18/10.
- Aptas para procesos de refrigeración, congelación, hornos microondas o distribución de alimentos.
- Higiénicos y fácilmente lavables, aptas para el lavavajillas.

- Fabriquées en acier inoxydable et en acier inoxydable 18/10.
- Compatibles pour des processus de réfrigération, congélation, fours à micro-ondes ou distribution d'aliments.
- Hygiéniques et facilement lavables, compatible lave-vaisselle.

- Manufactured in stainless steel and stainless steel 18/10.
- Suitable for refrigeration and freezing processes, microwave ovens or food distribution.
- Hygienic and easily washable, dishwasher safe.

2/1  
530 x 650 mm



## Cubeta 2/1

Bac 2/1 · GN-Behälter 2/1  
Container 2/1 · Caixa 2/1

Inox 18/10	Inox	Ref	€	L	h (cm)	U.Venta
66002	66002Z	44,70	39,70	6,50	2,0	1
66040	66040Z	49,40	44,80	11,00	4,0	1
66065	66065Z	56,30	47,10	18,90	6,5	1
66010	66010Z	68,80	57,60	31,50	10,0	1
66015	66015Z	83,10	72,50	44,90	15,0	1
66020	66020Z	108,10	96,70	60,00	20,0	1



## Cubeta perforada 2/1

Bac perfore 2/1 · GN-Behälter, perforiert, 2/1  
Perforated container 2/1 · Caixa perforada 2/1

Inox 18/10	Inox	Ref	€	h (cm)	U.Venta
-	-	-	-	-	-
66042	-	60,60	-	4,0	1
66067	66067Z	76,20	53,50	6,5	1
66012	66012Z	93,90	65,80	10,0	1
66017	-	140,60	-	15,0	1

1/1  
530 x 325 mm



## Cubeta 1/1

Bac 1/1 · GN-Behälter 1/1  
Container 1/1 · Caixa 1/1

Inox 18/10	Inox	Ref	€	h (cm)	L	U.Venta
66102	66102Z	22,10	18,70	2,0	3,00	1
66140	66140Z	23,20	20,00	4,0	5,50	1
66155	66155Z	26,00	21,20	5,5	7,20	1
66165	66165Z	28,00	21,90	6,5	8,50	1
66110	66110Z	39,80	29,80	10,0	13,30	1
66115	66115Z	47,20	40,90	15,0	20,60	1
66120	66120Z	55,70	49,60	20,0	30,00	1



## Cubeta perforada 1/1

Bac perfore 1/1 · GN-Behälter, perforiert, 1/1  
Perforated container 1/1 · Caixa perforada 1/1

Inox 18/10	Inox	Ref	€	h (cm)	U.Venta
66104	-	33,30	-	2,0	1
66142	66142Z	39,60	22,30	4,0	1
-	-	-	-	-	-
66167	66167Z	43,70	24,10	6,5	1
66112	66112Z	56,30	33,70	10,0	1
66117	66117Z	83,50	54,40	15,0	1
66122	66122Z	95,80	66,00	20,0	1

2/3  
354 x 325 mm



## Cubeta 2/3

Bac 2/3 · GN-Behälter 2/3  
Container 2/3 · Caixa 2/3

Inox 18/10	Inox	Ref	€	h (cm)	L	U.Venta
66502	66502Z	19,20	15,80	2,0	1,70	1
66540	66540Z	24,20	20,50	4,0	3,50	1
66565	66565Z	27,70	23,20	6,5	5,50	1
66510	66510Z	34,40	28,80	10,0	8,90	1
66515	66515Z	48,10	40,10	15,0	13,60	1
66520	66520Z	64,00	53,60	20,0	19,30	1



## Cubeta perforada 2/3

Bac perfore 2/3 · GN-Behälter, perforiert, 2/3  
Perforated container 2/3 · Caixa perforada 2/3

Inox 18/10	Inox	Ref	€	h (cm)	U.Venta
-	-	-	-	-	-
-	-	-	-	-	-
-	66567Z	20,70	6,5	1	
-	66512Z	29,60	10,0	1	
-	66517Z	40,10	15,0	1	

### Cubeta 1/2

Bac 1/2 · GN-Behälter 1/2  
Container 1/2 · Caixa 1/2



1/2  
265 x 325 mm

Inox 18/10		Inox		h (cm)	L	U.Venta
Ref	€	Ref	€			
66202	14,90	66202Z	10,50	2,0	1,20	1
66240	15,70	66240Z	10,90	4,0	2,50	1
-	-	66255Z	12,20	5,5	3,20	1
66265	17,90	66265Z	12,70	6,5	4,20	1
66210	26,00	66210Z	17,90	10,0	8,00	1
66215	33,30	66215Z	25,70	15,0	9,90	1
66220	42,60	66220Z	31,70	20,0	11,60	1

### Cubeta perforada 1/2

Bac perforé 1/2 · GN-Behälter, perforiert, 1/2  
Perforated container 1/2 · Caixa perforada 1/2



Inox 18/10		Inox		h(cm)	U.Venta
Ref	€	Ref	€		
-	-	-	-	-	-
66242	28,10	-	-	4,0	1
-	-	-	-	-	-
66267	32,20	-	-	6,5	1
66212	39,50	-	-	10,0	1
66217	53,50	-	-	15,0	1
66222	74,30	-	-	20,0	1

### Cubeta 2/4

Bac 2/4 · GN-Behälter 2/4  
Container 2/4 · Caixa 2/4



2/4  
530 x 165 mm

Inox 18/10		Inox		h (cm)	L	U.Venta
Ref	€	Ref	€			
67604	20,90	67604Z	17,40	4,0	1,80	1
67665	23,70	67665Z	19,50	6,5	4,50	1
67610	29,40	67610Z	24,20	10,0	5,50	1
67615	44,40	67615Z	36,40	15,0	8,50	1

### Cubeta 1/3

Bac 1/3 · GN-Behälter 1/3  
Container 1/3 · Caixa 1/3



1/3  
176 x 325 mm

Inox 18/10		Inox		h (cm)	L	U.Venta
Ref	€	Ref	€			
66302	14,00	66302Z	7,90	2,0	0,80	6
66340	14,10	66340Z	8,70	4,0	1,60	6
66355	14,50	66355Z	9,00	5,5	2,00	6
66365	14,70	66365Z	9,20	6,5	2,50	6
66310	21,10	66310Z	14,50	10,0	3,80	1
66315	30,80	66315Z	19,50	15,0	5,90	1
66320	35,30	66320Z	23,00	20,0	8,10	1

### Cubeta 1/4

Bac 1/4 · GN-Behälter 1/4  
Container 1/4 · Caixa 1/4



1/4  
265 x 162 mm

Inox 18/10		Inox		h (cm)	L	U.Venta
Ref	€	Ref	€			
66402	10,50	66402Z	7,20	2,0	0,60	6
66465	11,70	66465Z	7,90	6,5	1,90	6
66410	17,50	66410Z	12,30	10,0	2,50	1
66415	24,00	66415Z	16,40	15,0	4,10	1
66420	32,70	66420Z	19,80	20,0	4,90	1

### Cubeta 1/6

Bac 1/6 · GN-Behälter 1/6  
Container 1/6 · Caixa 1/6



1/6  
176 x 162 mm

Inox 18/10		Inox		h (cm)	L	U.Venta
Ref	€	Ref	€			
66665	9,50	66665Z	6,40	6,5	1,10	6
66610	15,20	66610Z	9,80	10,0	1,60	6
66615	23,80	66615Z	13,60	15,0	2,50	1
66620	29,90	66620Z	16,10	20,0	3,30	1

### Cubeta 1/9

Bac 1/9 · GN-Behälter 1/9  
Container 1/9 · Caixa 1/9



1/9  
176 x 108 mm

Inox 18/10		Inox		h (cm)	L	U.Venta
Ref	€	Ref	€			
66965	8,20	66965Z	4,70	10,0	0,70	6
66910	14,30	66910Z	7,50	6,5	0,85	6

### Guia divisora

Guide de division · GN Zwischensteg  
Splitting guides · Guia divisória



Inox 18/10		Inox		Largo (cm)	U.Venta
Ref	€	Ref	€		
66923	13,60	66923Z	5,70	53,0	1
66925	10,10	66925Z	3,70	32,5	1

### Doble fondo perforado

Double fond perforé · Doppel-Boden gelocht  
Punched double bottom perf. · Duplo fundo perforado



Inox 18/10		Inox		Cubeta
Ref	€	Ref	€	
66909	103,50	-	-	2/1
66911	33,00	66911Z	21,90	1/1
66912	22,50	66912Z	14,80	1/2

### Tapa para cubeta

Couvercle pour bac · GN Deckel  
Container lid · Tampa para caixa



Inox 18/10		Inox		Cubeta	U.Venta
Ref	€	Ref	€		
67901	24,70	67901Z	17,30	1/1	1
67905	15,10	67905Z	10,50	2/3	1
67902	13,50	67902Z	9,30	1/2	6
67903	9,80	67903Z	6,70	1/3	6
67904	8,20	67904Z	5,70	1/4	6
67906	6,70	67906Z	4,70	1/6	6
67909	5,70	67909Z	4,00	1/9	6

### Tapa para cubeta con pomo

Couvercle pour bac · GN Deckel  
Container lid · Tampa para caixa



Inox 18/10		Inox		Cubeta	U.Venta
Ref	€	Ref	€		
-	-	66908DZ	36,10	2/1	1
66901D	24,90	66901DZ	17,20	1/1	1
66905D	19,70	66905DZ	11,80	2/3	1
66907	15,90	-	-	2/4	1
66902D	13,10	66902DZ	8,40	1/2	6
66903D	10,50	66903DZ	6,50	1/3	6
66904D	8,90	66904DZ	6,00	1/4	6
66906D	6,70	66906DZ	3,50	1/6	6
66909D	6,20	66909DZ	2,60	1/9	6

### SI

Silicone



### Tapa para cubeta Red

Couvercle pour bac · GN Deckel  
Container lid · Tampa para caixa

Inox 18/10		Inox		Cubeta	U.Venta
Ref	€	Ref	€		
66901	73,20	66901Z	43,70	1/1	1
66903	59,10	66903Z	30,90	2/3	1
66902	53,60	66902Z	34,40	1/2	1
66904	43,40	66904Z	24,00	1/3	1
66905	40,10	66905Z	22,30	1/4	1

Varilla · Rod: Ø6 mm



### Parrilla

Grille · Gitter, Rost  
Grate · Grelha

Ref	€	cm	Medidas Cubeta	U.Venta
66920	55,10	65x53	2/1	1
66921	21,20	53x32,5	1/1	1

Varilla  
Rod: Ø3 mm

### INOX

### Pinza para bandeja GN

Pince inox pour bac Gastronorm · Zange für GN Behälter  
Tong GN tray · Pinça para forno e bandejas GN

Ref	€	Largo (cm)	U.Venta
62989	17,50	20	12

INOX 200°C  
Max

### Pinza para bandeja GN con silicona

Pince inox pour bac Gastronorm · Zange für GN Behälter  
Tong GN tray · Pinça para forno e bandejas GN

Ref	€	Largo (cm)	U.Venta
62998	17,50	20	12

### Especial para helado



### Cubeta para helado Inox 18/10

Bac à glace · Eiskübel  
Ice cream container · Caixa de sorvete

Ref	€	cm	h(cm)	L	U.Venta
66178	27,80	36x16,5	8	3,8	1
66172	27,90	36x16,5	12	5,0	1
66175	35,20	36x16,5	15	6,5	1
66900P	9,90	36x16,5	7,6	-	1



PC  
Policarbonate

### Cubeta para helado Policarbonato

Bac à glace · Eiskübel  
Ice cream container · Caixa de sorvete

Ref	€	cm	h(cm)	L	U.Venta
66172P	9,90	36x16,5	12,0	5,0	6
66908P	6,80	36x16,5	2	-	6

A- Compatible con tapas (66900P/66908P)

Compatible with lids (66900P/66908P)

B- Compatible con cubetas (66175/66172P)

Compatible with containers (669175/66172P)

# Cubetas Policarbonato



- Fabricada en policarbonato. Ligera, indeformable y apilable.
- Apta para procesos de refrigeración, congelación, hornos microondas o distribución de alimentos (-100°C/100°C).
- Higiénica y fácilmente lavable. Apta para el lavavajillas.

- Fabriqué en polycarbonate. Léger, indéformable et empilable.
- Convient pour le refroidissement, le congélation, les fours à micro-ondes ou la distribution des aliments (-100 ° C / 100 ° C).
- Hygiénique et facilement lavable. Convient au lave-vaisselle.

- Manufactured in polycarbonate. Light, undeformable and stackable.
- Suitable for cooling, freezing, microwave ovens or food distribution (-100°C/100°C).
- Hygienic and easily washable. Suitable for dishwasher.

1/1  
530 x 325 mm



1/2  
265 x 325 mm



1/3  
176 x 325 mm



## Cubeta 1/1

Bac 1/1 · GN-Behälter 1/1  
Container 1/1 · Caixa 1/1

Ref	€	h (cm)	L	U.Venta
66165P	24,00	6,5	8,50	1
66110P	29,60	10,0	13,30	1
66115P	36,30	15,0	20,60	1
66120P	44,70	20,0	30,00	1

## Cubeta 1/2

Bac 1/2 · GN-Behälter 1/2  
Container 1/2 · Caixa 1/2

Ref	€	h (cm)	L	U.Venta
66265P	12,70	6,5	4,20	1
66210P	16,90	10,0	8,00	1
66215P	21,80	15,0	9,90	1
66220P	26,60	20,0	11,60	1

## Cubeta 1/3

Bac GN 1/3 · GN-Behälter 1/3  
GN container 1/3 · Caixa GN 1/3

Ref	€	h (cm)	L	U.Venta
66365P	10,40	6,5	2,50	1
66310P	13,50	10,0	3,80	1
66315P	16,80	15,0	5,90	1
66320P	20,40	20,0	8,10	1

1/4  
265 x 162 mm



1/6  
176 x 162 mm



1/9  
176 x 108 mm



## Cubeta 1/4

Bac 1/4 · GN-Behälter 1/4  
Container 1/4 · Caixa 1/4

Ref	€	h (cm)	L	U.Venta
66465P	9,20	6,5	1,90	1
66410P	11,00	10,0	2,50	1
66415P	13,90	15,0	4,10	1

## Cubeta 1/6

Bac 1/6 · GN-Behälter 1/6  
Container 1/6 · Caixa 1/6

Ref	€	h (cm)	L	U.Venta
66665P	7,80	6,5	1,10	1
66610P	8,30	10,0	1,60	1
66615P	10,00	15,0	2,50	1

## Cubeta 1/9

Bac 1/9 · GN-Behälter 1/9  
Container 1/9 · Caixa 1/9

Ref	€	h(cm)	L	U.Venta
66910P	7,80	10,0	0,70	1

## Tapa

Couvercle · Deckel  
Lid · Tampa

Ref	€	Cubeta	U.Venta
66901P	18,30	1/1	1
66902P	11,30	1/2	1
66903P	8,00	1/3	1
66904P	6,60	1/4	1
66906P	4,90	1/6	1
66909P	3,90	1/9	1

## Doble fondo perforado

Double fond perce · GN Einlege-Böden, gelocht  
Punched double bottom · Duplo fundo perforado

Ref	€	Cubeta	U.Venta
66911P	13,70	1/1	1
66912P	7,50	1/2	1
66913P	4,80	1/3	1
66914P	3,80	1/4	1
66916P	3,40	1/6	1

# Cubetas Polipropileno



- Fabricada en policarbonato. Ligera, indeformable y apilable.
- Apta para procesos de refrigeración, congelación, hornos microondas o distribución de alimentos (-100°C/100°C).
- Higiénica y fácilmente lavable. Apta para el lavavajillas.

- Fabriqué en polycarbonate. Léger, indéformable et empilable.
- Convient pour le refroidissement, le congélation, les fours à micro-ondes ou la distribution des aliments (-100 ° C / 100 ° C).
- Hygiénique et facilement lavable. Convient au lave-vaisselle.

- Manufactured in polycarbonate. Light, undeformable and stackable.
- Suitable for cooling, freezing, microwave ovens or food distribution (-100°C/100°C).
- Hygienic and easily washable. Suitable for dishwasher.

1/1  
530 x 325 mm



1/2  
265 x 325 mm



1/3  
176 x 325 mm



## Cubeta 1/1

Bac 1/1 · GN-Behälter 1/1  
Container 1/1 · Caixa 1/1

Ref	€	h (cm)	L	U.Venta
66165H	11,30	6,5	8,50	1
66110H	13,50	10,0	12,90	1
66115H	16,90	15,0	19,50	1
66120H	21,60	20,0	25,90	1

## Cubeta 1/2

Bac 1/2 · GN-Behälter 1/2  
Container 1/2 · Caixa 1/2

Ref	€	h (cm)	L	U.Venta
66265H	5,90	6,5	3,90	6
66210H	8,30	10,0	5,90	6
66215H	9,70	15,0	8,80	6
66220H	11,40	20,0	10,80	1

## Cubeta 1/3

Bac 1/3 · GN-Behälter 1/3  
Container 1/3 · Caixa 1/3

Ref	€	h (cm)	L	U.Venta
66365H	4,70	6,5	2,40	6
66310H	5,60	10,0	3,80	6
66315H	6,90	15,0	5,10	6
66320H	8,40	20,0	6,90	6

1/4  
265 x 162 mm



1/6  
176 x 162 mm



1/9  
176 x 108 mm



## Cubeta 1/4

Bac 1/4 · GN-Behälter 1/4  
Container 1/4 · Caixa 1/4

Ref	€	h (cm)	L	U.Venta
66465H	3,90	6,5	1,70	6
66410H	5,20	10,0	2,40	6
66415H	5,60	15,0	3,70	6

## Cubeta 1/6

Bac 1/6 · GN-Behälter 1/6  
Container 1/6 · Caixa 1/6

Ref	€	h (cm)	L	U.Venta
66665H	3,60	6,5	1,00	6
66610H	3,80	10,0	1,60	6
66615H	5,30	15,0	2,20	6

## Cubeta 1/9

Bac 1/9 · GN-Behälter 1/9  
Container 1/9 · Caixa 1/9

Ref	€	h (cm)	L	U.Venta
66965H	2,60	6,5	0,60	6
66910H	3,60	10,0	0,90	6

## Tapa

Couvercle · Deckel  
Lid · Tampa

Ref	€	Cubeta	U.Venta
66901DH	8,50	1/1	6
66902DH	5,00	1/2	6
66903DH	3,70	1/3	6
66904DH	3,10	1/4	6
66906DH	2,20	1/6	6
66909DH	2,00	1/9	6

## Doble fondo perforado

Double fond perce · GN Einlege-Böden, gelocht  
Punched double bottom · Duplo fundo perforado

Ref	€	Cubeta	U.Venta
66911H	9,80	1/1	10
66912H	5,00	1/2	12
66913H	2,90	1/3	12
66914H	2,20	1/4	12
66916H	1,60	1/6	12

# Cubetas Melamina Black

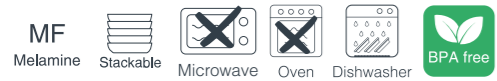

- Fabricadas en melamina de alta calidad.
- Libres de BPA.
- Ligeras, indeformables y apilables.
- Higiénicas y fácilmente lavables.
- Aptas para procesos de refrigeración, congelación o distribución de alimentos.

- Fabriqué en mélamine de haute qualité.
- Sans BPA.
- Légères, indéformables et empilables.
- Hygiéniques et facilement lavables.
- Compatibles pour des processus de réfrigération, congélation ou distribution d'aliments.

- Made of high quality melamine.
- BPA free.
- Light, non-deformable and stackable.
- Hygienic and easily washable.
- Suitable for refrigeration and freezing processes and food distribution.

1/1  
530 x 325 mm



## Cubeta 1/1

Bac 1/1 · GN-Behälter 1/1  
Container 1/1 · Caixa 1/1

Ref	€	h(cm)	L	U.Venta
66165J	48,30	6,5	8,50	1
66110J	54,30	10	13,30	1

1/2  
265 x 325 mm



## Cubeta 1/2

Bac 1/2 · GN-Behälter 1/2  
Container 1/2 · Caixa 1/2

Ref	€	h(cm)	L	U.Venta
66265J	24,80	6,5	4,50	1
66210J	27,90	10	8,00	1

1/3  
176 x 325 mm



## Cubeta 1/3

Bac 1/3 · GN-Behälter 1/3  
Container 1/3 · Caixa 1/3

Ref	€	h(cm)	L	U.Venta
66365J	19,80	6,5	2,50	1
66310J	22,00	10	3,80	1

1/4  
265 x 162 mm



## Cubeta 1/4

Bac 1/4 · GN-Behälter 1/4  
Container 1/4 · Caixa 1/4

Ref	€	h(cm)	L	U.Venta
66465J	17,00	6,5	1,90	1
66410J	19,10	10	2,50	1

2/3  
350 x 325 mm



## Cubeta 2/3

Bac 2/3 · GN-Behälter 2/3  
Container 2/3 · Caixa 2/3

Ref	€	h(cm)	L	U.Venta
66565J	35,70	6,5	5,50	1

1/6  
176 x 162 mm



## Cubeta 1/6

Bac 1/6 · GN-Behälter 1/6  
Container 1/6 · Caixa 1/6

Ref	€	h(cm)	L	U.Venta
66665J	12,10	6,5	1,10	1
66610J	13,70	10	1,60	1

2/4  
530 x 165 mm



## Cubeta 2/4

Bac 2/4 · GN-Behälter 2/4  
Container 2/4 · Caixa 2/4

Ref	€	h(cm)	L	U.Venta
66765J	24,70	6,5	4,50	1

# Cubetas Melamina White



- Fabricadas en melamina de alta calidad.
- Libres de BPA.
- Ligeras, indeformables y apilables.
- Higiénicas y fácilmente lavables.
- Aptas para procesos de refrigeración, congelación o distribución de alimentos.

- Fabriqué en mélamine de haute qualité.
- Sans BPA.
- Légères, indéformables et empilables.
- Hygiéniques et facilement lavables.
- Compatibles pour des processus de réfrigération, congélation ou distribution d'aliments.

- Made of high quality melamine.
- BPA free.
- Light, non-deformable and stackable.
- Hygienic and easily washable.
- Suitable for refrigeration and freezing processes and food distribution.

1/1  
530 x 325 mm



## Cubeta 1/1

Bac 1/1 · GN-Behälter 1/1  
Container 1/1 · Caixa 1/1

Ref	€	h(cm)	L	U.Venta
66165E	45,40	6,5	8,50	1
66110E	51,70	10,0	13,30	1

1/2  
265 x 325 mm



## Cubeta 1/2

Bac 1/2 · GN-Behälter 1/2  
Container 1/2 · Caixa 1/2

Ref	€	h(cm)	L	U.Venta
66265E	23,70	6,5	4,50	1
66210E	26,30	10	8,00	1

1/3  
176 x 325 mm



## Cubeta 1/3

Bac 1/3 · GN-Behälter 1/3  
Container 1/3 · Caixa 1/3

Ref	€	h(cm)	L	U.Venta
66365E	18,50	6,5	2,50	1
66310E	20,50	10	3,80	1

1/4  
265 x 162 mm



## Cubeta 1/4

Bac 1/4 · GN-Behälter 1/4  
Container 1/4 · Caixa 1/4

Ref	€	h(cm)	L	U.Venta
66465E	15,90	6,5	1,90	1
66410E	17,90	10	2,50	1

2/3  
350 x 325 mm



## Cubeta 2/3

Bac 2/3 · GN-Behälter 2/3  
Container 2/3 · Caixa 2/3

Ref	€	h(cm)	L	U.Venta
66565E	34,20	6,5	5,50	1

1/6  
176 x 162 mm



## Cubeta 1/6

Bac 1/6 · GN-Behälter 1/6  
Container 1/6 · Caixa 1/6

Ref	€	h(cm)	L	U.Venta
66665E	11,40	6,5	1,10	1
66610E	12,70	10	1,60	1

2/4  
530 x 165 mm



## Cubeta 2/4

Bac 2/4 · GN-Behälter 2/4  
Container 2/4 · Caixa 2/4

Ref	€	h(cm)	L	U.Venta
66765E	23,80	6,5	4,50	1

# Transporte y almacenamiento

## Transport and storage

# Caja isotérmica y carros

EPP  
Expanded Polypropylene



INOX

PP  
Polypropylene



Totalmente plegables para ahorrar espacio.  
Totally foldable to save space

## Caja isotérmica Temple

PBoîte isotherme · Isothermische Box  
Isothermal box · Caixa isotérmica

	Ref	€	cm	h(cm)	L	U.Venta
A	66064	22,30	38x38	22	18,0	1
B	66066	38,20	60x40	25	38,5	1

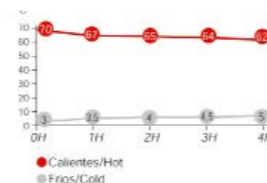

## Termotrans

Thermotrans · Thermotrans  
Thermotrans · Thermotrans

	Ref	€	cm	L	U. Venta
A	66099	622,70	41x62x24	17	1
B	66299	666,70	41x62x37	34	1
C	66599	823,70	45x62,5x57,5	72	1



## Entrega desmontado

Dismantled delivery



## Carro servicio Basic

Chariot de service · Servierwagen  
Service trolley · Carro serviço

Ref	€	cm	U.Venta
66249	190,80	82x64,5x94,5	1

## Entrega desmontado

Dismantled delivery



## Carro servicio Desmontable

Chariot de service · Servierwagen  
Service trolley · Carro serviço

Ref	€	cm	U.Venta
66349	247,10	82x64,5x94,5	1

## Entrega montado

Mounted delivery



## Carro servicio soldado

Chariot de service · Servierwagen  
Service trolley · Carro serviço soldado

Ref	€	cm	U.Venta
66350	726,00	82x64,5x94,5	1

PE  
Polyethylene

## Carro servicio Black

Chariot de service · Servierwagen  
Service trolley · Carro serviço

Ref	€	cm	U.Venta
66353	271,40	103x49x95	1



## Contenedor cubiertos

Bac plastique pour couverts · Besteckebehälter aus Plastik  
Cutlery plastic bin · Recipiente de talheres plástico

Ref	€	cm	L	U.Venta
66351	40,10	33x23x18	9 L	1

## Contenedor desperdicio

Bac à déchets plastique · Müllbehälter aus Plastik  
Rubbish plastic bin · Recipiente de desperdícios em plástico

Ref	€	cm	L	U.Venta
66352	66,90	33x284x56	30 L	1



**Pestillo de bloqueo**  
Locking tab



**Fácil de plegar**  
Easy to fold



### Carro servicio plegable

Chariot de servie pliable · Faltbarer servierwagen  
Folding service cart · Carro de serviço dobrável

Ref	€	cm	U.Venta
66247	445,60	93x51x93,5	1



MAX: Ø30,5 cm  
MIN: Ø19 cm  
CAP: 360 units



PP

Polypropylene



190 Kg

### Carro cortaplatos

Chariot porte-plateau · Tellerwagen  
Dish cart · Carro porta-pratos

Ref	€	cm	h(cm)	Capacidad	U.Venta
66555	1376,70	96x71	81,0	360 platos	1



### Funda carro portaplatos

Housse chariot porte-plateau · Abdeckung für tellerwagen  
Dish cart cover · Capa protectora carro porta-pratos

Ref	€	cm	U.Venta
62964	49,10	96x71x60	1

Ø tubo · tube: 1,7 cm

Separación entre tubos · Separation between tubes: 5 cm

INOX  
18/10



### Estante tubular inox

Étagère tubulaire en Inox · Rohrgestell-Regal, Rostfrei  
St. steel tubular shelf · Prateleira tubular Inóx

Ref	€	Medidas	U.Venta
56212	129,60	120 x 25 x 15 cm	1
56216	141,20	160 x 25 x 15 cm	1
56412	188,20	120 x 40 x 15 cm	1
56416	201,50	160 x 40 x 15 cm	1

### Entrega desmontado

Dismantled delivery



INOX

### Carro portabandejas

Chariot à glissières · Gestellwagen  
Rack trolley · Carro porta-bandejas

Ref	€	cm	Ancho (cm)	Medidas Cubeta	U.Venta
66116	908,10	38x55x172	7,5	GN 1/1	1
66118	1008,20	58x69x172	7,5	GN 2/1	1
66642	849,60	45x62x172	6,0	60x40	1

### Entrega montado

Mounted delivery

MAX: Ø28 cm  
MIN: Ø8 cm  
CAP: 100 units

INOX



### Carro portaplatos con ruedas

Hors devers chariot · Tellertransportwagen  
Stack trolley assembled · Carro porta-pratos com rodas

Ref	€	cm	Capacidad	U.Venta
66550	1739,80	70x70x195	100 platos	1

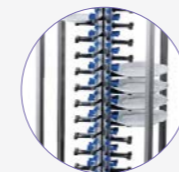
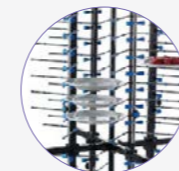
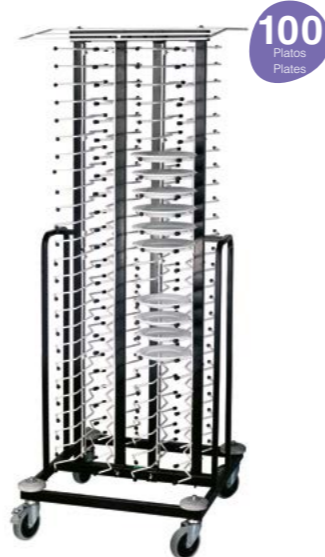

FE AL INOX  
Iron Aluminium 18/10

### Carro portaplatos

Chariot à plaques · Tellerwagen  
Plate trolley · Carro de pratos

Ref	€	cm	Capacidad	U.Venta
66551	865,70	58x58x174,5	80 platos	1
66552	934,10	73x73x191	84 platos	1

A B

### Detalle colocación platos

Detail of plate placement

AL  
Aluminium

### Soporte portaplatos

Support de plaque · Plattenhalter  
Plate holder · Suporte de placas

Ref	€	cm	Capacidad	U.Venta
66553	342,70	55x55x113	48 platos	1



### Detalle colocación platos

Detail of plate placement

### Soporte platos pared

Support de plaque murale · Wandplattenhalter  
Wall plate holder · Suporte de placa de parede

Ref	€	cm	Capacidad	U.Venta
66556	167,90	12x10x81	9 platos	1
66557	191,80	12x10x101,5	12 platos	1



80  
Platos  
Plates

84  
Platos  
Plates

48  
Platos  
Plates



48  
Platos  
Plates

9-12  
Platos  
Plates



- Ideal para hostelería, restaurantes, bares, cocinas, catering, hoteles, etc.
- Solución eficiente y práctica para el proceso de emplatado.
- Versátil; su sistema de sujeción permite adecuar diferentes tamaños y formas.
- Platos compatibles de Ø15-Ø32cm. Bandejas de hasta 32 cm de longitud.
- La sujeción es extremadamente firme evitando deslizamientos y roturas.
- Apila de forma cómoda y sencilla gran cantidad de platos. Capacidad para 80-84 platos.
- Estructura de hierro con un acabado pintado en negro.
- Soporte intermedio para un mejor manejo y transporte.
- Fácil de transportar. 4 ruedas giratorias, 2 de ellas con freno.
- Se suministra desmontado.

- Ideal for the catering, restaurants, bars, kitchens, catering, hotels, etc.
- Efficient and practical solution for the plating process.
- Versatile; its fastening system allows to adapt different sizes and shapes.
- Compatible plates from Ø15-Ø32cm. Trays up to 32 cm in length.
- Extremely firm clamping system prevents slipping and breakage.
- Stacks easily and comfortably a large number of plates. Capacity for 80-84 plates.
- Iron structure with black painted finish.
- Intermediate support for better handling and transport.
- Easy to transport. 4 swivel wheels, 2 of them with brakes.
- Supplied disassembled.

- Ideal para hostelería, restaurantes, bares, cocinas, catering, hoteles, etc.
- Solución eficiente y práctica para el proceso de emplatado.
- Base sólida que asegura la estabilidad del soporte, evitando caídas y asegurando un manejo seguro de los platos.
- Regulable en cada columna independientemente, para ajustarse a la altura del plato consiguiendo una perfecta sujeción.
- Fácil de transportar.
- Platos compatibles de Ø10 - Ø32 cm. Bandejas de hasta 32 cm de longitud.
- Permite apilar de forma cómoda y sencilla gran cantidad de platos.
- Capacidad para 48 platos.
- Se suministra desmontado.

- Ideal for catering, restaurants, bars, kitchens, catering, hotels, etc.
- Efficient and practical solution for the plating process.
- Solid base that ensures the stability of the support, avoiding falls and ensuring safe handling of the plates.
- Independently adjustable on each column, to adjust to the height of the plate, achieving a perfect hold.
- Easy to transport.
- Compatible plates from Ø10 - Ø32 cm. Trays up to 32 cm in length.
- Allows a large number of plates to be stacked easily and conveniently.
- Capacity for 48 plates.
- Supplied disassembled.

- Ideal para hostelería, restaurantes, bares, cocinas, catering, hoteles, etc.
- Solución eficiente y práctica para el proceso de emplatado.
- Estable y seguro. Ahorra espacio.
- Ajuste de altura de platos mediante regulador superior de rosca.
- La sujeción es extremadamente firme evitando deslizamientos y roturas.
- Fijación en pared mediante tornillería (incluida), permite un aprovechamiento óptimo del espacio
- Platos compatibles de Ø10 - Ø32 cm. Bandejas de hasta 32 cm de longitud.
- Capacidad para 9 platos.

- Idéal pour la restauration, les restaurants, les bars, les cuisines, la restauration, les hôtels, etc.
- Solution efficace et pratique pour le processus de placage.
- Stable et sûr. Peu encombrant.
- Réglage de la hauteur des assiettes à l'aide d'une vis de réglage.
- Fixation extrêmement solide pour éviter les glissements et les cassures.
- Fixation murale à l'aide de vis (incluses), permettant une utilisation optimale de l'espace.
- Plaques compatibles de Ø10 à Ø32 cm. Plateaux jusqu'à 32 cm de long.
- Capacité de 9 assiettes.

- Ideal for catering, restaurants, bars, kitchens, catering, hotels, etc.
- Efficient and practical solution for the plating process.
- Stable and safe. Space saving.
- Height adjustment of plates by means of screw top adjuster.
- Extremely firm fixing to prevent slipping and breakage.
- Wall mounting by means of screws (included), allowing optimum use of space.
- Compatible plates from Ø10 - Ø32 cm. Trays up to 32 cm long.
- Capacity for 9 plates.

# Bandejas autoservicios



- Ideal para diferentes colectivos como buffets, self-service, hospitales, colegios, guarderías, campamentos, etc.
- Compartimentos para alimentos y para cubiertos.
- Higiénicas, fáciles de recoger, limpiar y guardar; ocupan poco espacio.
- Apilables.

- Idéal pour différents groupes tels que buffets, self-service, hôpitaux, écoles, crèches, camps, etc.
- Compartiments pour les aliments et pour les couverts.
- Hygiénique, faciles à collecter, nettoyer et ranger; il prend peu de place.
- Empilable.

- Ideal for different groups such as buffets, self-service, hospitals, schools, nurseries, camps, etc.
- Compartments for food and for cutlery.
- Hygienic, easy to collect, clean and store; it takes up little space.
- Stackable.



Asas de silicona  
Silicone handles

5 compartimentos  
5 compartments

INOX 18/10 INOX SI  
Silicone

## Bandeja autoservicio Inox

Plateau libre-service · Selbstbedienungstablett  
Self-service tray · Bandeja self-service

Ref	€	Material	cm	h(cm)	U.Venta
66957	26,40	Inox 18/10	32,5x37,5	3,6	1
66957Z	22,10	Inox	32,5x37,5	3,6	1
R66957A	0,80	Silicona	-	-	1

## Tapa apta para bandejas polipropileno

Lid suitable for polypropylene trays



## Tapa apta para bandejas policarbonato

Lid suitable for polycarbonate trays



## Tapa para bandeja autoservicio

Couvercle pour plateau self-service · Deckel für Selbstbedienung Tablett  
Lid for self-service tray · Tampa para bandeja auto-serviço

Ref	€	Material	cm	U.Venta
A 66960	14,70	Polypropylene	53x37	1
B 66962	19,30	Polycarbonate	53x37	1

## La misma bandeja sirve como tapa

The same tray serves as a lid

PP PC  
Polypropylene Polycarbonate

## Bandeja autoservicio

Plateau self-service · Selbstbedienung Tablett  
Self-service tray · Bandeja auto-serviço

Ref	€	Material	cm	U.Venta
A 66952	20,00	Polycarbonate	33x33	1
B 66951	12,20	Polypropylene	33x33	1
C 66961	20,30	Polycarbonate	33x33	1

PP  
Polypropylene

## Bandeja servicio Basic

Plateau rectangulaire · Tablet, rechtecking  
Rectangular tray · Bandeja de servir

Ref	€	cm	U.Venta
66953	17,90	53x37	1



## Bandeja Servicio Red

Plateau de service · Serviertablett  
Serving tray · Bandeja de servir

Ref	€	cm	U.Venta
66990	5,10	35x27	1
66991	6,10	41,5x30,5	1
66992	7,00	45x35	1



## Bandeja Servicio Blue

Plateau de service · Serviertablett  
Serving tray · Bandeja de servir

Ref	€	cm	U.Venta
66993	5,10	35x27	1
66994	6,10	41,5x30,5	1
66995	7,00	45x35	1



## Bandeja Servicio Cream

Plateau de service · Serviertablett  
Serving tray · Bandeja de servir

Ref	€	cm	U.Venta
66996	5,10	35x27	1
66997	6,10	41,5x30,5	1
66998	7,00	45x35	1

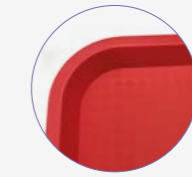

Superficie anti-deslizante y anti-rayado  
Anti-slip and anti-scratch surface



100% libres de BPA

Propiedades anti-bacterianas

- Bandejas diseñadas para el sector profesional, especialmente Catering y FastFood.
- Fabricadas en polipropileno, 100% libres de BPA.
- Ligeras, resistentes, apilables y reciclables.
- Superficie anti-deslizante y anti-rayado, diseñadas para uso intensivo.
- Propiedades anti-bacterianas.
- Aptas para lavavajillas.
- 3 colores disponibles: rojo/azul/cream.
- 3 tamaños disponibles.

- Plateaux conçus pour le secteur professionnel, en particulier pour la restauration collective et la restauration rapide.
- Fabriqués en polypropylène, 100% sans BPA.
- Légers, résistants, empilables et recyclables.
- Surface antidérapante et anti-rayures, conçue pour un usage intensif.
- Propriétés antibactériennes.
- Passe au lave-vaisselle.
- 3 couleurs disponibles : rouge/bleu/ crème.
- 3 tailles disponibles.

- Trays designed for the professional sector, especially Catering and FastFood.
- Made of polypropylene, 100% BPA free.
- Lightweight, resistant, stackable and recyclable.
- Anti-slip and anti-scratch surface, designed for intensive use.
- Anti-bacterial properties.
- Dishwasher safe.
- 3 colours available: red/blue/cream.
- 3 sizes available.



# Bandejas Isotérmicas

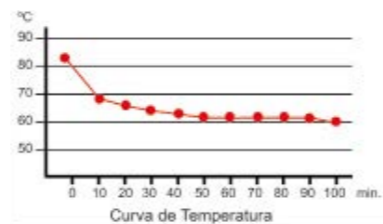

**COMPOSICIÓN:**  
 66930 - Bandeja isotérmica B-1  
 66933 - Plato llano con tapa  
 66934 - Plato hondo con tapa  
 66937 - Bol con tapa  
 66959 - Bol rectangular con tapa  
 66956 - Cierre portafichas hermético



## Bandeja isotérmica B1

Plateau Isotherme B-1 · Isothermal Schale/Tablett B-1  
 Isothermal B-1, Tray · Bandeja isotérmica B-1

Ref	€	cm	U.Venta
66930	211,90	53x36,5x11	1



## Set completo bandeja isotérmica B1

Set complet B-1 · Komplet-Set B-1  
 Complete set B-1 · Conjunto completo bandeja isotérmica B-1

Ref	€	cm	U.Venta
66942	246,10	53x36,5	1



## Plato llano con tapa

Assiette plate polycarbonate avec couvercle · Grosser Teller, Polycarbonat mit deckel  
 Polycarbonate dinner plate with lid · Prato raso polycarbonato com tampa

Ref	€	cm	U.Venta
66933	15,80	Ø22x3	1
66933C	11,20	-	1
66940	4,70	-	1

Conjunto · Set

Plato · Platte

Tapa · Lid



## Plato hondo con tapa

Assiette creuse polycarbonate a/couvercle · Suppenteller, Polycarbonat mit deckel  
 Polycarbonate sopper plate with lid · Prato fundo polycarbonato com tampa

Ref	€	cm	ml	U.Venta
66934	10,40	Ø19x5	450	1
66934C	5,90	-	450	1
66939	4,50	-	-	1

Conjunto · Set

Plato · Platte

Tapa · Lid



## Bol con tapa

Bol polycarbonate avec couvercle · Schüssel, Polycarbonat mit deckel  
 Polycarbonate bowl with lid · Tijela polycarbonato com tampa

Ref	€	cm	ml	U.Venta
66937	6,80	Ø13x6,5	450	1
66937C	5,20	-	450	1
66938	1,50	-	-	1

Conjunto · Set

Taza · Cup

Tapa · Lid

## Bol doble pared con tapa

Bol isotherme polycarb. a/couvercle · Polycarbonat Schüssel, Isothermal mit Deckel  
 Double wall polycarbonate bowl w/lid · Tijela parede dupla polycarbonato c/ tampa

Ref	€	Ø (cm)	ml	U.Venta
66948	14,30	12,5x7	500	1
66948S	12,80	12,5x7	500	1
66938	1,50	12,5	-	1

Conjunto · Set

Taza · Cup

Tapa · Lid



## Taza desayuno con tapa

Coupelle dessert polycarbonate a/couvercle · Frühstückstasse Polycarbonat m/Deckel  
 Polycarbonate breakfast cup w/lid · Chávena pequeno-almoço com tampa

Ref	€	Ø (cm)	ml	U.Venta
66936	5,30	9x7	300	1
66936C	4,10	9x7	300	1
66936T	1,20	9	-	1

Conjunto · Set

Taza · Cup

Tapa · Lid



## Vaso

Verre polycarbonate · Glas, Polycarbonat  
 Polycarbonate glass · Copo polycarbonato

Ref	€	Ø (cm)	ml	U.Venta
66947	2,40	7x10	250	1
66932	3,30	8,3x9,5	300	12



## Tapa cubreplatos redondo

Couvercle pour assiettes Polycarbonate · Polycarbonat Teller-Abdeckung  
 Polycarbonate round plat cover · Tampa cobre-pratos redonda polycarbonato

Ref	€	Ø (cm)	U.Venta
66950	12,30	25x7	1



## Plato desayuno

Assiette dessert polycarbonate · Frühstücksteller, Polycarbonat  
 Polycarbonate breakfast plate · Prato de pequeno-almoço polycarbonato

Ref	€	cm	U.Venta
66935	5,00	Ø18x2,5	1



## Jarra

Pot verser polycarbonate · Krug, Polycarbonat  
 Polycarbonate jug · Jarra polycarbonato

Ref	€	L	U.Venta
66945	12,40	1,00	1
66945S	9,40	1,00	1
66945T	2,90	-	1

Conjunto · Set

Jarra · Jug

Tapa · Lid



## Carro portabandejas

Chariot plateau · Wagen für Schale/Tablett  
 Isothermal tray trolley · Carro porta-bandejas

Ref	€	cm	Capacidad	U.Venta
66931	3267,30	90x62x148	20 bandejas	1

# Estanterías

AL  
Aluminium

- Las estanterías modulares LACOR no precisan para su montaje/desmontaje de herramienta alguna, son fáciles de montar, robustas y ligeras.
- Construidas en materiales de alta calidad garantizan una larga duración, además de adecuarse al uso alimenticio en cámaras refrigeradas. La construcción modular permite al cliente adecuarse a la longitud y espacios disponibles, pudiendo ampliar y modificar la distribución en cualquier momento.
- Diseñadas para poder emplear cubetas GASTRONORM 2/1, 1/1 y 2/3, con dos anchuras de fondo disponibles, 560 mm y 385 mm.
- La distribución de los estantes permite el máximo aprovechamiento de la altura disponible, con un máximo de 11 estantes en altura 1750 mm y 12 estantes en altura de 2000 mm, con un peso máximo aproximado por estantería de 1.200 Kg. Con una altura útil mínima de 100 mm es especialmente recomendada para el almacenaje de medicamentos, artículos de ferretería o alimentos en conserva.
- Las distintas alturas de los estantes y su fácil montaje/desmontaje, permite que las distancias entre estantes puedan variarse a razón de 150 mm adicionales a los 100 mm iniciales (100mm/250mm/400mm/550mm)

- Les étagères modulaires LACOR ne nécessitent aucun outil pour leur montage/démontage. Elles sont faciles à monter, robustes et légères.
- Elles sont construites dans des matériaux d'une grande qualité qui garantissent une longue durée de vie, et s'adaptent à une utilisation alimentaire dans les chambres froides.
- La construction modulaire permet au client de les adapter à la longueur et aux espaces disponibles, avec la possibilité d'agrandir ou de modifier la distribution à tout moment.
- Conçues pour l'emploi de bacs GASTRONORM 2/1, 1/1 et 2/3, avec deux largeurs de fond disponibles, 560 mm et 385 mm L'agencement des étagères permet de profiter au maximum de la hauteur disponible, avec un nombre limite de 11 étagères en hauteur de 1750 mm et de 12 étagères en hauteur de 2000 mm, pour un poids maximum d'environ 1.200 Kg par étagère. Avec une hauteur utile minimale de 100 mm, elle est spécialement conseillée pour stocker des médicaments, des articles de quincaillerie ou des aliments en conserve.
- Les différentes hauteurs des étagères et leur facilité de montage/démontage permettent de varier la distance entre étagères de 150 mm supplémentaires par rapport aux 100 mm d'origine (100mm/250mm/400mm/550mm).

- No tools are required in the assembly/disassembly of LACOR modular shelving; they are easy to assemble, robust and light.
- Built in top-quality material, they are guaranteed to be long-lasting, and also apt for storing food in refrigerators.
- Their modular construction allows the client to fit them lengthwise into the available space, being able to expand and modify their distribution at anytime.
- Designed for use with GASTRONORM 2/1, 1/1 and 2/3 trays, with two available depths, 560mm and 385mm The shelves' distribution allows for maximum use of available height, with a maximum height of 11 shelves at 1750mm and 12 shelves 2000mm, with an approximate maximum weight of 1,200kg per shelf.
- With a minimum height of 100mm, it's especially recommended for storing medicine, tools or canned foods.
- The different shelf heights and easy assembly / disassembly make it so the distances between shelves can vary by 150mm from the initial 100mm (100mm/250mm/400mm/550mm).

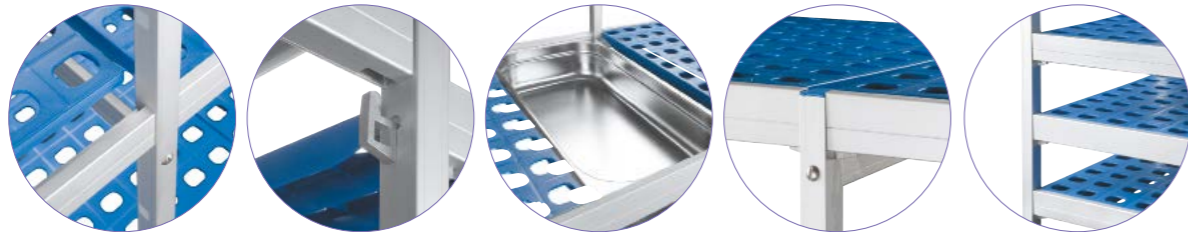

Capacidad por estante  
Capacity per shelf  
Distribuir el peso uniformemente  
Distributing the weight evenly

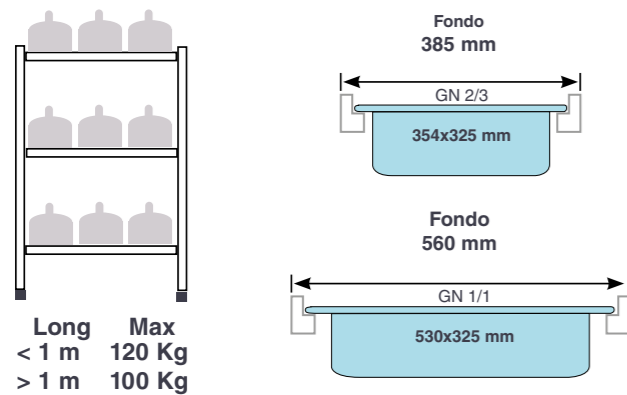

## Instrucciones montaje

Las estanterías LACOR no precisan de herramienta alguna para su montaje o desmontaje; siga estas instrucciones para poder realizar el montaje de una estantería simple. En caso de precisar cualquier aclaración o información adicional, no dude en ponerse en contacto con su suministrador o visite nuestra página web.

- Extraiga todos los componentes de su embalaje original, no se deshaga de este hasta comprobar que el artículo se encuentra completo. Coloque todos los componentes en el suelo.
- Disponga de un espacio libre, ampliamente superior a las dimensiones de la estantería a montar.
- Tome un soporte lateral extendido en el suelo, introduzca 2 ganchos en los orificios más bajos que vaya a emplear, tal y como muestra la figura 1. Apoye este soporte lateral contra la pared.
- Tome el otro soporte lateral e introduzca los ganchos en los mismos orificios. Coloque ahora los 2 largueros de la parte inferior (figura 2).
- Coloque de pie este soporte lateral y aproxímese al soporte lateral apoyado contra la pared, introduzca los largueros en los ganchos de éste, la estantería quedará estabilizada (figura 3). Asegúrese de que los largueros han sido correctamente colocados.
- Ahora puede seleccionar las diferentes alturas a las cuales colocará los ganchos y largueros de los estantes (figura 4).
- Antes de colocar las parrillas plásticas, asegúrese de que todos los largueros se encuentran correctamente colocados.
- Montaje guía ángulo:
  - Retire todas las parrillas plásticas y extraiga uno de los largueros de la estantería.
  - Introduzca 2 ganchos de ángulo en la barra ángulo tal y como muestra la figura (figura 6 y 7).  
NOTA: deberá emplear tantas barras ángulo como estantes disponga (figura 5).
  - Introduzca el larguero por la barra ángulo con los ganchos laterales (figura 8).
  - Ahora coloque el larguero con las barras ángulo en su anterior ubicación. Realice el mismo proceso con todos los largueros de uno de los laterales.
  - Una vez terminado, asegúrese de colocar todas las barras ángulo contra el mismo extremo, ahora realice el montaje de los 2 largueros de la parte inferior (figura 9).
  - Coloque en el nuevo soporte lateral 2 ganchos a la misma altura que la estantería ya montada.
  - Monte el nuevo soporte lateral a los largueros que forman el ángulo (figura 9); asegúrese de introducirlos correctamente.
  - Ahora ya puede montar el resto de largueros hasta finalizar el montaje.
  - Antes de colocar las parrillas plásticas, asegúrese de que todos los largueros se encuentran correctamente colocados  
NOTA: las patas pueden regularse en altura 1 cm para absorber irregularidades del suelo, emplee una llave inglesa o fija de 17 mm

## Mounting instructions

The LACOR shelves do not need any tool whatsoever to be assembled or dismantled. Follow these instructions to be able to assemble one single shelf. If you need any further explanation or information, do not hesitate to contact your supplier or visit our website.

- Take all the components out of their original wrapping. Do not throw the wrapping away until you have checked that the article is complete. Place all the components on the floor.
- Make a space available that is much larger than the shelf to be assembled.
- Take a side support lying on the floor and put two hooks into the lowest holes you are going to use, as shown in figure 1. Lean this support against the wall.
- Take the other side support and put the hooks into the same holes. Now place the 2 lower rods (figure 2).
- Stand this side support up and bring it next to the side support leaning against the wall. Put the rod lengths into its hooks. The shelf will remain stabilized (figure 3). Make sure the rod lengths have been properly placed.
- Now you can select the different heights at which you will place the hooks and the shelf rod lengths (figure 4).
- Before placing the plastic racks, make sure that all the rods are properly in place.
- Assembly of angle guide rail:
  - Remove all the plastic racks and take out one of the shelf rod lengths.
  - Put 2 angle hooks into the angle bar as shown (figure 6 and Figure 7).  
NOTE: you must use as many angle bars as the number of shelves you have (figure 5).
  - Put the rod length through the angle bar with the side hooks (figure 8).
  - Now place the rod length with the angle bars in its previous place. Follow the same process with all the rod lengths of one of the sides.
  - Once finished, make sure you place all the angle bars against the same end. Now assemble the 2 lower rod lengths (figure 9).
  - Place 2 hooks on the new side support at the same height as the shelf assembled.
  - Mount the new side support onto the rod lengths that form the angle (figure 9). Make sure you introduce them properly.
  - Now you can assemble the rest of the rod lengths until you finish the assembly.
  - Before placing the plastic racks, make sure that all the rod lengths are properly placed.  
NOTE: the legs can be adjusted by 1 cm in height to absorb unevenness in the floor. Use an adjustable or 17 mm fixed spanner.



AL  
Aluminium

### Soporte lateral

Support latérale · Seitenständer  
Lateral support · Suporte latera

385 mm (GN 2/3)	560 mm (GN 1/1)
Fondo / Width	Fondo / Width

Ref	€	Ref	€	h (cm)
56302	33,30	57302	37,40	25
56317	91,10	57317	98,60	175
56320	106,50	57320	113,80	200



AL  
Aluminium

### Set ángulo 90°

Jeu angle 90° · Eckesatz 90°  
90° corner set · Conjunto ângulo 90°

Ref	€	L (mm)	U.Venta
56330	15,70	385	1
57330	20,10	560	1



AL PP  
Aluminium Polypropylene BPA free

### Rueda para estantería

Rove pour étagère · Rad für Regal  
Shelf wheel · Roda para prateleira

Ref	€	U.Venta
A 56522	46,50	1
B 56523	63,20	1

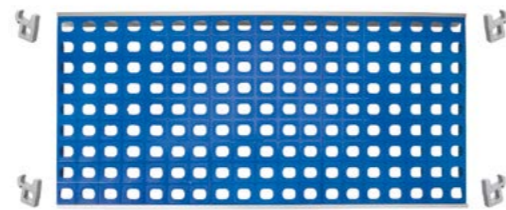

AL PP  
Aluminium Polypropylene BPA free

### Estantería completa

Rayonnage complet · Regale, komplett  
Full shelving · Estantes completa

385 mm (GN 2/3)	560 mm (GN 1/1)
Fondo / Width	Fondo / Width

Ref	€	Ref	€	L (mm)	U.Venta
56007	47,80	57007	56,30	710	1
56008	50,70	57008	59,40	820	1
56009	56,30	57009	64,50	930	1
56010	64,50	57010	76,60	1035	1
56011	69,80	57011	81,70	1145	1
56012	74,00	57012	87,00	1255	1
56013	76,60	57013	91,90	1365	1
56014	87,00	57014	101,50	1470	1
56015	89,50	57015	107,30	1580	1



AL  
Aluminium

### Barra soporte lateral

Barre support latérale · Seitenständer stange  
Lateral support bar · Barra soporte lateral

Ref	€	h (mm)	U.Venta
56502	9,30	250	1
56517	33,10	1750	1
56520	36,40	2000	1

AL  
Aluminium

### Travesaño soporte lateral

Longeron support latérale · Seitenständer traverse  
Lateral support crossbar · Travesaño soporte lateral

Ref	€	L (mm)	U.Venta
56321	5,60	385	1
57321	8,20	560	1



AL  
Aluminium BPA free

### Travesaño

Longeron · Traverse  
Crossbar · Travesano

Ref	€	L (mm)	U.Venta
56507	14,50	654	1
56508	15,40	766	1
56509	17,70	876	1
56510	19,30	981	1
56511	20,80	1091	1
56512	22,40	1201	1
56513	23,80	1311	1
56514	25,40	1416	1
56515	26,30	1526	1

AL  
Aluminium

### Juego 4 ganchos

Jeu 4 crochet pour l'angle · 4 Satz Haken für ecke  
4 pcs. set corner hooks · Jogo 4 ganchos ângulo

Ref	€	U.Venta
56527	2,50	1

Travesaño · Crossbar



Barra · Bar

PP  
Polypropylene

### Parrilla

Clayete en polyéthilène · Polyethylen Boden/Raster  
Polyethylene rack · Grelha polietileno

Ref	€	mm	U.Venta
56325	7,40	353x325	1
56435	8,50	353x425	3
57325	11,40	530x325	1
57435	14,00	530x435	1

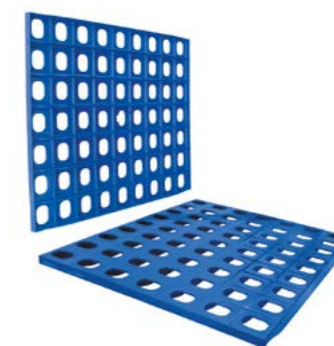

AL  
Aluminium

### Set ángulo 90° Rep.

Jeu angle 90° · Eckesatz 90°  
90° corner set · Conjunto ângulo 90°

Ref	€	L (mm)	U.Venta
56322	14,70	385	1
57322	19,00	560	1

AL  
Aluminium

### Jgo. 4 ganchos travesaño

Jeu 4 crochet pour longeron · 4 Satz Haken für traverse  
4 pcs. crossbar hooks · Jogo 4 ganchos travesano

Ref	€	U.Venta
56524	3,10	1



INOX  
18/10

### Juego 6 tornillos

Jeu 6 vis en Inox · 6 Satz schrauben  
6 pcs. set screws · Jogo 6 parafusos

Ref	€	U.Venta
56526	2,30	1



PP  
Polypropylene

### Jgo. 2 pie nivelación

Jeu 2 pied nivellement · 2 Satz niveau füsse  
26 pcs. set level foot · Jogo pé nivelamento

Ref	€	U.Venta
56525	4,90	1



**385x250 mm**

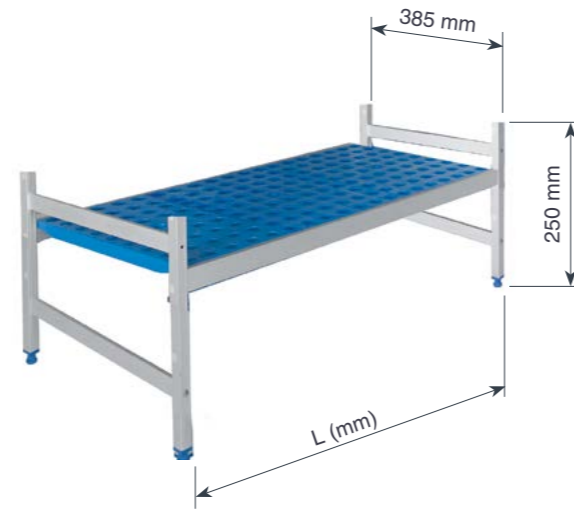

**Bancada completa**

Banc complet · Bank, komplett  
Complete bench · Banco completo

**1 Estante · Shelf**

Ref	€	L (mm)	Desglose
55400	<b>115,60</b>	710	56302 x 2 / 56007 x 1
55401	<b>118,10</b>	822	56302 x 2 / 56008 x 1
55402	<b>123,30</b>	932	56302 x 2 / 56009 x 1
55403	<b>131,00</b>	1037	56302 x 2 / 56010 x 1
55404	<b>136,20</b>	1147	56302 x 2 / 56011 x 1
55405	<b>140,50</b>	1257	56302 x 2 / 56012 x 1
55406	<b>143,00</b>	1367	56302 x 2 / 56013 x 1
55407	<b>153,40</b>	1472	56302 x 2 / 56014 x 1
55408	<b>155,80</b>	1582	56302 x 2 / 56015 x 1

**560x250 mm**



**Bancada completa**

Banc complet · Bank, komplett  
Complete bench · Banco completo

**1 Estante · Shelf**

Ref	€	L (mm)	Desglose
55700	<b>131,40</b>	710	57302 x 2 / 57007 x 1
55701	<b>134,10</b>	822	57302 x 2 / 57008 x 1
55702	<b>139,20</b>	932	57302 x 2 / 57009 x 1
55703	<b>151,30</b>	1037	57302 x 2 / 57010 x 1
55704	<b>156,50</b>	1147	57302 x 2 / 57011 x 1
55705	<b>161,70</b>	1257	57302 x 2 / 57012 x 1
55706	<b>166,40</b>	1367	57302 x 2 / 57013 x 1
55707	<b>176,80</b>	1472	57302 x 2 / 57014 x 1
55708	<b>181,70</b>	1582	57302 x 2 / 57015 x 1

**385x1750 mm**



**Estantería completa**

Rayonnage complet · Regale, komplett  
Full shelving · Estantes completa

**3 Estantes · Shelf**

**4 Estantes · Shelf**

**5 Estantes · Shelf**

Ref	€	L (mm)	Desglose	SIMPLE	
				Ref	€
55409	<b>329,30</b>	710	56317 x 2 + 56007 x 3	55446	<b>377,40</b>
55410	<b>337,30</b>	822	56317 x 2 + 56008 x 3	55447	<b>389,10</b>
55411	<b>352,80</b>	932	56317 x 2 + 56009 x 3	55448	<b>408,40</b>
55412	<b>375,80</b>	1037	56317 x 2 + 56010 x 3	55449	<b>439,60</b>
55413	<b>390,20</b>	1147	56317 x 2 + 56011 x 3	55450	<b>460,50</b>
55414	<b>404,70</b>	1257	56317 x 2 + 56012 x 3	55451	<b>478,60</b>
55415	<b>411,40</b>	1367	56317 x 2 + 56013 x 3	55452	<b>488,80</b>
55416	<b>443,00</b>	1472	56317 x 2 + 56014 x 3	55453	<b>529,90</b>
55417	<b>449,40</b>	1582	56317 x 2 + 56015 x 3	55454	<b>540,20</b>

Ref	€	L (mm)	Desglose	DOBLE · DOUBLE	
				Ref	€
55418	<b>614,10</b>	1719	56317 x 3 + 56007 x 3 + 56010	55455	<b>727,70</b>
55419	<b>629,80</b>	1829	56317 x 3 + 56007 x 3 + 56011	55456	<b>747,90</b>
55420	<b>642,90</b>	1939	56317 x 3 + 56007 x 3 + 56012	55457	<b>765,00</b>
55421	<b>660,90</b>	2046	56317 x 2 + 56010 x 6	55458	<b>789,60</b>
55422	<b>681,40</b>	2154	56317 x 3 + 56007 x 3 + 56014	55459	<b>817,20</b>
55423	<b>689,10</b>	2264	56317 x 3 + 56007 x 3 + 56015	55460	<b>826,80</b>
55424	<b>696,80</b>	2376	56317 x 3 + 56010 x 3 + 56013	55461	<b>837,90</b>
55425	<b>727,90</b>	2481	56317 x 3 + 56010 x 3 + 56014	55462	<b>879,30</b>
55426	<b>735,50</b>	2591	56317 x 3 + 56010 x 3 + 56015	55463	<b>888,80</b>
55427	<b>751,00</b>	2701	56317 x 3 + 56011 x 3 + 56015	55464	<b>910,20</b>
55428	<b>764,10</b>	2811	56317 x 3 + 56013 x 3 + 56014	55465	<b>927,70</b>
55429	<b>794,40</b>	2916	56317 x 2 + 56014 x 6	55466	<b>968,80</b>
55430	<b>801,50</b>	3026	56317 x 3 + 56014 x 3 + 56015	55467	<b>978,80</b>
55431	<b>810,10</b>	3136	56317 x 3 + 56015 x 6	55468	<b>989,30</b>

Ref	€	L (mm)	Desglose	TRIPLE	
				Ref	€
55432	<b>973,80</b>	3275	56317 x 4 + 56010 x 6 + 56012	55469	<b>1177,20</b>
55433	<b>981,50</b>	3385	56317 x 4 + 56010 x 6 + 56013	55470	<b>1187,40</b>
55434	<b>1012,40</b>	3490	56317 x 4 + 56010 x 6 + 56014	55471	<b>1228,50</b>
55435	<b>1033,10</b>	3598	56317 x 4 + 56007 x 3 + 56014	55472	<b>1255,90</b>
55436	<b>1043,80</b>	3710	56317 x 4 + 56011 x 6 + 56014	55473	<b>1270,00</b>
55437	<b>1048,30</b>	3818	56317 x 4 + 56007 x 3 + 56015	55474	<b>1276,20</b>
55438	<b>1079,60</b>	3925	56317 x 4 + 56010 x 3 + 56014	55475	<b>1318,30</b>
55439	<b>1095,30</b>	4035	56317 x 4 + 56011 x 3 + 56014	55476	<b>1345,40</b>
55440	<b>1099,10</b>	4145	56317 x 4 + 56010 x 3 + 56015	55477	<b>1352,20</b>
55441	<b>1110,40</b>	4255	56317 x 4 + 56011 x 3 + 56015	55478	<b>1359,20</b>
55442	<b>1146,90</b>	4360	56317 x 4 + 56014 x 9	55479	<b>1407,50</b>
55443	<b>1154,50</b>	4470	56317 x 4 + 56014 x 6 + 56015	55480	<b>1417,70</b>
55444	<b>1161,90</b>	4580	56317 x 4 + 56014 x 3 + 56015	55481	<b>1427,90</b>
55445	<b>1169,70</b>	4690	56317 x 4 + 56015 x 9	55482	<b>1437,90</b>

**385x2000 mm**

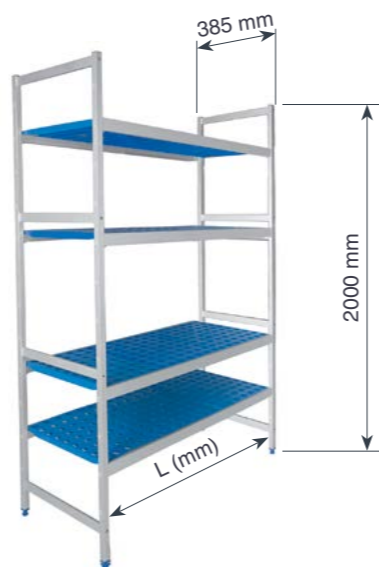

**Estantería completa**

Rayonnage complet · Regale, komplett  
Full shelving · Estantes completa

SIMPLE

3 Estantes · Shelf				4 Estantes · Shelf			5 Estantes · Shelf		
Ref	€	L (mm)	Desglose	Ref	€	Desglose	Ref	€	Desglose
55520	<b>360,00</b>	710	56320 x 2 + 56007 x 3	55557	<b>408,80</b>	56320 x 2 + 56007 x 4	55594	<b>457,80</b>	56320 x 2 + 56007 x 5
55521	<b>367,70</b>	822	56320 x 2 + 56008 x 3	55558	<b>419,50</b>	56320 x 2 + 56008 x 4	55595	<b>471,10</b>	56320 x 2 + 56008 x 5
55522	<b>381,70</b>	932	56320 x 2 + 56009 x 3	55559	<b>439,90</b>	56320 x 2 + 56009 x 4	55596	<b>496,60</b>	56320 x 2 + 56009 x 5
55523	<b>405,60</b>	1037	56320 x 2 + 56010 x 3	55560	<b>470,70</b>	56320 x 2 + 56010 x 4	55597	<b>535,10</b>	56320 x 2 + 56010 x 5
55524	<b>421,80</b>	1147	56320 x 2 + 56011 x 3	55561	<b>491,70</b>	56320 x 2 + 56011 x 4	55598	<b>561,40</b>	56320 x 2 + 56011 x 5
55525	<b>435,10</b>	1257	56320 x 2 + 56012 x 3	55562	<b>508,90</b>	56320 x 2 + 56012 x 4	55599	<b>583,10</b>	56320 x 2 + 56012 x 5
55526	<b>442,60</b>	1367	56320 x 2 + 56013 x 3	55563	<b>519,30</b>	56320 x 2 + 56013 x 4	55600	<b>595,90</b>	56320 x 2 + 56013 x 5
55527	<b>473,40</b>	1472	56320 x 2 + 56014 x 3	55564	<b>560,40</b>	56320 x 2 + 56014 x 4	55601	<b>647,20</b>	56320 x 2 + 56014 x 5
55528	<b>481,00</b>	1582	56320 x 2 + 56015 x 3	55565	<b>570,40</b>	56320 x 2 + 56015 x 4	55602	<b>659,90</b>	56320 x 2 + 56015 x 5

DOBLE · DOUBLE

Ref	€	L (mm)	Desglose	Ref	€	Desglose	Ref	€	Desglose
55529	<b>659,40</b>	1719	56320 x 3 + 56007 x 3 + 56010	55566	<b>773,30</b>	56320 x 3 + 56007 x 4 + 56010	55603	<b>886,80</b>	56320 x 3 + 56007 x 5 + 56010
55530	<b>675,50</b>	1829	56320 x 3 + 56007 x 3 + 56011	55567	<b>793,20</b>	56320 x 3 + 56007 x 4 + 56011	55604	<b>912,80</b>	56320 x 3 + 56007 x 5 + 56011
55531	<b>688,60</b>	1939	56320 x 3 + 56007 x 3 + 56012	55568	<b>811,60</b>	56320 x 3 + 56007 x 4 + 56012	55605	<b>934,70</b>	56320 x 3 + 56007 x 5 + 56012
55532	<b>706,10</b>	2046	56320 x 3 + 56010 x 6	55569	<b>835,30</b>	56320 x 3 + 56010 x 8	55606	<b>964,30</b>	56320 x 3 + 56010 x 10
55533	<b>726,90</b>	2154	56320 x 3 + 56007 x 3 + 56014	55570	<b>862,80</b>	56320 x 3 + 56007 x 4 + 56014	55607	<b>998,80</b>	56320 x 3 + 56007 x 5 + 56014
55534	<b>734,40</b>	2264	56320 x 3 + 56007 x 3 + 56015	55571	<b>872,10</b>	56320 x 3 + 56007 x 4 + 56015	55608	<b>1011,40</b>	56320 x 3 + 56007 x 5 + 56015
55535	<b>742,50</b>	2376	56320 x 3 + 56010 x 3 + 56013	55572	<b>883,30</b>	56320 x 3 + 56010 x 4 + 56013	55609	<b>1024,80</b>	56320 x 3 + 56010 x 5 + 56013
55536	<b>773,40</b>	2481	56320 x 3 + 56010 x 3 + 56014	55573	<b>924,90</b>	56320 x 3 + 56010 x 4 + 56014	55610	<b>1076,30</b>	56320 x 3 + 56010 x 5 + 56014
55537	<b>780,90</b>	2591	56320 x 3 + 56010 x 3 + 56015	55574	<b>934,90</b>	56320 x 3 + 56010 x 4 + 56015	55611	<b>1089,00</b>	56320 x 3 + 56010 x 5 + 56015
55538	<b>796,70</b>	2701	56320 x 3 + 56011 x 3 + 56015	55575	<b>955,90</b>	56320 x 3 + 56011 x 4 + 56015	55612	<b>1115,00</b>	56320 x 3 + 56011 x 5 + 56015
55539	<b>808,60</b>	2811	56320 x 3 + 56013 x 3 + 56014	55576	<b>973,20</b>	56320 x 3 + 56013 x 4 + 56014	55613	<b>1136,80</b>	56320 x 3 + 56013 x 5 + 56014
55540	<b>839,60</b>	2916	56320 x 2 + 56014 x 6	55577	<b>1014,30</b>	56320 x 3 + 56014 x 8	55614	<b>1188,30</b>	56320 x 3 + 56014 x 10
55541	<b>848,30</b>	3026	56320 x 3 + 56014 x 3 + 56015	55578	<b>1024,70</b>	56320 x 3 + 56014 x 4 + 56015 x	55615	<b>1201,00</b>	56320 x 3 + 56014 x 5 + 56015 x
55542	<b>855,80</b>	3136	56320 x 3 + 56015 x 6	55579	<b>1034,60</b>	56320 x 3 + 56015 x 8	55616	<b>1213,50</b>	56320 x 3 + 56015 x 10

TRIPLE

Ref	€	L (mm)	Desglose	Ref	€	Desglose	Ref	€	Desglose
55543	<b>1034,70</b>	3275	56320 x 4 + 56010 x 6 + 56012	55580	<b>1238,00</b>	56320 x 4 + 56010 x 8 + 56012	55617	<b>1441,10</b>	56320 x 4 + 56010 x 10 + 56012
55544	<b>1042,40</b>	3385	56320 x 4 + 56010 x 6 + 56013	55581	<b>1248,20</b>	56320 x 4 + 56010 x 8 + 56013	55618	<b>1453,90</b>	56320 x 4 + 56010 x 10 + 56013
55545	<b>1073,30</b>	3490	56320 x 4 + 56010 x 6 + 56014	55582	<b>1289,30</b>	56320 x 4 + 56010 x 8 + 56014	55619	<b>1505,30</b>	56320 x 4 + 56010 x 10 + 56014
55546	<b>1094,10</b>	3598	56320 x 4 + 56007 x 3 + 56014	55583	<b>1316,70</b>	56320 x 4 + 56007 x 4 + 56014	55620	<b>1539,70</b>	56320 x 4 + 56007 x 5 + 56014
55547	<b>1104,60</b>	3710	56320 x 4 + 56011 x 6 + 56014	55584	<b>1331,00</b>	56320 x 4 + 56011 x 8 + 56014	55621	<b>1557,40</b>	56320 x 4 + 56011 x 10 + 56014
55548	<b>1109,10</b>	3818	56320 x 4 + 56007 x 3 + 56015	55585	<b>1337,20</b>	56320 x 4 + 56007 x 4 + 56015	55622	<b>1565,00</b>	56320 x 4 + 56007 x 5 + 56015
55549	<b>1140,60</b>	3925	56320 x 4 + 56010 x 3 + 56014	55586	<b>1379,00</b>	56320 x 4 + 56010 x 4 + 56014	55623	<b>1617,10</b>	56320 x 4 + 56010 x 5 + 56014
55550	<b>1155,90</b>	4035	56320 x 4 + 56011 x 3 + 56014	55587	<b>1399,70</b>	56320 x 4 + 56011 x 4 + 56014	55624	<b>1643,20</b>	56320 x 4 + 56011 x 5 + 56014
55551	<b>1155,50</b>	4145	56320 x 4 + 56010 x 3 + 56015	55588	<b>1399,30</b>	56320 x 4 + 56010 x 4 + 56015	55625	<b>1642,60</b>	56320 x 4 + 56010 x 5 + 56015
55552	<b>1171,30</b>	4255	56320 x 4 + 56011 x 3 + 56015	55589	<b>1420,00</b>	56320 x 4 + 56011 x 4 + 56015	55626	<b>1668,60</b>	56320 x 4 + 56011 x 5 + 56015
55553	<b>1207,70</b>	4360	56320 x 4 + 56014 x 9	55590	<b>1467,90</b>	56320 x 4 + 56014 x 12	55627	<b>1729,20</b>	56320 x 4 + 56014 x 15
55554	<b>1215,40</b>	4470	56320 x 4 + 56014 x 6 + 56015	55591	<b>1477,70</b>	56320 x 4 + 56014 x 8 + 56015	55628	<b>1741,90</b>	56320 x 4 + 56014 x 10 + 56015
55555	<b>1222,90</b>	4580	56320 x 4 + 56014 x 3 + 56015	55592	<b>1488,80</b>	56320 x 4 + 56014 x 4 + 56015	55629	<b>1754,70</b>	56320 x 4 + 56014 x 5 + 56015
55556	<b>1230,50</b>	4690	56320 x 4 + 56015 x 9	55593	<b>1499,00</b>	56320 x 4 + 56015 x 12	55630	<b>1767,20</b>	56320 x 4 + 56015 x 15

**560x1750 mm**



**Estantería completa**

Rayonnage complet · Regale, komplet  
Full shelving · Estantes completa

SIMPLE

3 Estantes · Shelf				4 Estantes · Shelf			5 Estantes · Shelf		
Ref	€	L (mm)	Desglose	Ref	€	Desglose	Ref	€	Desglose
55709	<b>367,70</b>	710	57317 x 2 + 57007 x 3	55746	<b>424,00</b>	57317 x 2 + 57007 x 4	55783	<b>481,40</b>	57317 x 2 + 57007 x 5
55710	<b>375,50</b>	822	57317 x 2 + 57008 x 3	55747	<b>433,70</b>	57317 x 2 + 57008 x 4	55784	<b>494,00</b>	57317 x 2 + 57008 x 5
55711	<b>390,20</b>	932	57317 x 2 + 57009 x 3	55748	<b>455,10</b>	57317 x 2 + 57009 x 4	55785	<b>520,10</b>	57317 x 2 + 57009 x 5
55712	<b>426,90</b>	1037	57317 x 2 + 57010 x 3	55749	<b>504,10</b>	57317 x 2 + 57010 x 4	55786	<b>580,60</b>	57317 x 2 + 57010 x 5
55713	<b>443,00</b>	1147	57317 x 2 + 57011 x 3	55750	<b>525,00</b>	57317 x 2 + 57011 x 4	55787	<b>606,60</b>	57317 x 2 + 57011 x 5
55714	<b>458,20</b>	1257	57317 x 2 + 57012 x 3	55751	<b>545,20</b>	57317 x 2 + 57012 x 4	55788	<b>632,00</b>	57317 x 2 + 57012 x 5
55715	<b>473,40</b>	1367	57317 x 2 + 57013 x 3	55752	<b>565,50</b>	57317 x 2 + 57013 x 4	55789	<b>657,40</b>	57317 x 2 + 57013 x 5
55716	<b>504,30</b>	1472	57317 x 2 + 57014 x 3	55753	<b>606,40</b>	57317 x 2 + 57014 x 4	55790	<b>709,00</b>	57317 x 2 + 57014 x 5
55717	<b>519,50</b>	1582	57317 x 2 + 57015 x 3	55754	<b>626,80</b>	57317 x 2 + 57015 x 4	55791	<b>733,90</b>	57317 x 2 + 57015 x 5

DOBLE · DOUBLE

Ref	€	L (mm)	Desglose	Ref	€	Desglose	Ref	€	Desglose
55718	<b>696,40</b>	1719	57317 x 3 + 57007 x 3 + 57010	55755	<b>829,90</b>	57317 x 3 + 57007 x 4 + 57010	55792	<b>963,40</b>	57317 x 3 + 57007 x 5 + 57010
55719	<b>712,00</b>	1829	57317 x 3 + 57007 x 3 + 57011	55756	<b>850,50</b>	57317 x 3 + 57007 x 4 + 57011	55793	<b>989,50</b>	57317 x 3 + 57007 x 5 + 57011
55720	<b>726,90</b>	1939	57317 x 3 + 57007 x 3 + 57012	55757	<b>870,50</b>	57317 x 3 + 57007 x 4 + 57012	55794	<b>1014,50</b>	57317 x 3 + 57007 x 5 + 57012
55721	<b>755,10</b>	2046	57317 x 3 + 57010 x 6	55758	<b>909,40</b>	57317 x 3 + 57010 x 8	55795	<b>1062,50</b>	57317 x 3 + 57010 x 10
55722	<b>773,40</b>	2154	57317 x 3 + 57007 x 3 + 57014	55759	<b>932,50</b>	57317 x 3 + 57007 x 4 + 57014	55796	<b>1091,30</b>	57317 x 3 + 57007 x 5 + 57014
55723	<b>787,30</b>	2264	57317 x 3 + 57007 x 3 + 57015	55760	<b>952,70</b>	57317 x 3 + 57007 x 4 + 57015	55797	<b>1116,80</b>	57317 x 3 + 57007 x 5 + 57015
55724	<b>802,10</b>	2376	57317 x 3 + 57010 x 3 + 57013	55761	<b>970,90</b>	57317 x 3 + 57010 x 4 + 57013	55798	<b>1139,50</b>	57317 x 3 + 57010 x 5 + 57013
55725	<b>832,50</b>	2481	57317 x 3 + 57010 x 3 + 57014	55762	<b>1011,90</b>	57317 x 3 + 57010 x 4 + 57014	55799	<b>1190,90</b>	57317 x 3 + 57010 x 5 + 57014
55726	<b>848,30</b>	2591	57317 x 3 + 57010 x 3 + 57015	55763	<b>1032,20</b>	57317 x 3 + 57010 x 4 + 57015	55800	<b>1216,00</b>	57317 x 3 + 57010 x 5 + 57015
55727	<b>863,50</b>	2701	57317 x 3 + 57011 x 3 + 57015	55764	<b>1052,90</b>	57317 x 3 + 57011 x 4 + 57015	55801	<b>1242,30</b>	57317 x 3 + 57011 x 5 + 57015
55728	<b>879,10</b>	2811	57317 x 3 + 57013 x 3 + 57014	55765	<b>1073,30</b>	57317 x 3 + 57013 x 4 + 57014	55802	<b>1267,50</b>	57317 x 3 + 57013 x 5 + 57014
55729	<b>909,80</b>	2916	57317 x 3 + 57014 x 6	55766	<b>1114,30</b>	57317 x 3 + 57014 x 8	55803	<b>1319,20</b>	57317 x 3 + 57014 x 10
55730	<b>925,10</b>	3026	57317 x 3 + 57014 x 3 + 57015	55767	<b>1134,80</b>	57317 x 3 + 57014 x 4 + 57015 x	55804	<b>1344,40</b>	57317 x 3 + 57014 x 5 + 57015 x
55731	<b>940,30</b>	3136	57317 x 3 + 57015 x 6	55768	<b>1154,90</b>	57317 x 3 + 57015 x 8	55805	<b>1369,60</b>	57317 x 3 + 57015 x 10

TRIPLE

Ref	€	L (mm)	Desglose	Ref	€	Desglose	Ref	€	Desglose
55732	<b>1115,60</b>	3275	57317 x 4 + 57010 x 6 + 57012	55769	<b>1355,60</b>	57317 x 4 + 57010 x 8 + 57012	55806	<b>1594,70</b>	57317 x 4 + 57010 x 10 + 57012
55733	<b>1130,70</b>	3385	57317 x 4 + 57010 x 6 + 57013	55770	<b>1376,00</b>	57317 x 4 + 57010 x 8 + 57013	55807	<b>1619,90</b>	57317 x

560x2000 mm

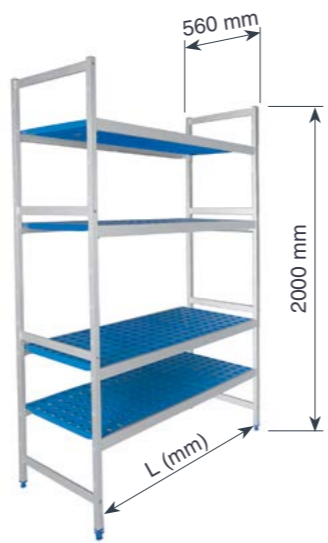

### Estantería completa

Rayonnage complet · Regale, komplett  
Full shelving · Estantes completa

SIMPLE

3 Estantes · Shelf			
Ref	€	L (mm)	Desglose
55820	398,40	710	57320 x 2 + 57007 x 3
55821	405,60	822	57320 x 2 + 57008 x 3
55822	421,50	932	57320 x 2 + 57009 x 3
55823	457,80	1037	57320 x 2 + 57010 x 3
55824	473,40	1147	57320 x 2 + 57011 x 3
55825	488,70	1257	57320 x 2 + 57012 x 3
55826	503,90	1367	57320 x 2 + 57013 x 3
55827	534,70	1472	57320 x 2 + 57014 x 3
55828	550,00	1582	57320 x 2 + 57015 x 3

4 Estantes · Shelf		
Ref	€	Desglose
55857	455,10	57320 x 2 + 57007 x 4
55858	465,20	57320 x 2 + 57008 x 4
55859	485,80	57320 x 2 + 57009 x 4
55860	534,40	57320 x 2 + 57010 x 4
55861	555,30	57320 x 2 + 57011 x 4
55862	575,80	57320 x 2 + 57012 x 4
55863	595,90	57320 x 2 + 57013 x 4
55864	637,00	57320 x 2 + 57014 x 4
55865	657,30	57320 x 2 + 57015 x 4

5 Estantes · Shelf		
Ref	€	Desglose
55894	511,70	57320 x 2 + 57007 x 5
55895	524,50	57320 x 2 + 57008 x 5
55896	550,40	57320 x 2 + 57009 x 5
55897	611,00	57320 x 2 + 57010 x 5
55898	637,10	57320 x 2 + 57011 x 5
55899	662,50	57320 x 2 + 57012 x 5
55900	688,00	57320 x 2 + 57013 x 5
55901	738,10	57320 x 2 + 57014 x 5
55902	763,40	57320 x 2 + 57015 x 5

Ref	€	L (mm)	Desglose
55829	741,10	1719	57320 x 3 + 57007 x 3 + 57010
55830	757,80	1829	57320 x 3 + 57007 x 3 + 57011
55831	771,90	1939	57320 x 3 + 57007 x 3 + 57012
55832	801,60	2046	57320 x 3 + 57010 x 6
55833	819,10	2154	57320 x 3 + 57007 x 3 + 57014
55834	833,90	2264	57320 x 3 + 57007 x 3 + 57015
55835	846,50	2376	57320 x 3 + 57010 x 3 + 57013
55836	877,50	2481	57320 x 3 + 57010 x 3 + 57014
55837	893,90	2591	57320 x 3 + 57010 x 3 + 57015
55838	909,50	2701	57320 x 3 + 57011 x 3 + 57015
55839	924,70	2811	57320 x 3 + 57013 x 3 + 57014
55840	955,50	2916	57320 x 3 + 57014 x 6
55841	970,90	3026	57320 x 3 + 57014 x 3 + 57015
55842	985,90	3136	57320 x 3 + 57015 x 6

Ref	€	Desglose
55866	875,50	57320 x 3 + 57007 x 4 + 57010
55867	895,90	57320 x 3 + 57007 x 4 + 57011
55868	915,60	57320 x 3 + 57007 x 4 + 57012
55869	954,90	57320 x 3 + 57010 x 8
55870	978,00	57320 x 3 + 57007 x 4 + 57014
55871	998,50	57320 x 3 + 57007 x 4 + 57015
55872	1016,40	57320 x 3 + 57010 x 4 + 57013
55873	1057,60	57320 x 3 + 57010 x 4 + 57014
55874	1077,90	57320 x 3 + 57010 x 4 + 57015
55875	1098,60	57320 x 3 + 57011 x 4 + 57015
55876	1119,10	57320 x 3 + 57013 x 4 + 57014
55877	1160,00	57320 x 3 + 57014 x 8
55878	1180,40	57320 x 3 + 57014 x 4 + 57015 x
55879	1200,80	57320 x 3 + 57015 x 8

Ref	€	Desglose
55903	1009,20	57320 x 3 + 57007 x 5 + 57010
55904	1034,80	57320 x 3 + 57007 x 5 + 57011
55905	1060,30	57320 x 3 + 57007 x 5 + 57012
55906	1108,30	57320 x 3 + 57010 x 10
55907	1137,00	57320 x 3 + 57007 x 5 + 57014
55908	1162,50	57320 x 3 + 57007 x 5 + 57015
55909	1184,90	57320 x 3 + 57010 x 5 + 57013
55910	1236,40	57320 x 3 + 57010 x 5 + 57014
55911	1262,00	57320 x 3 + 57010 x 5 + 57015
55912	1287,70	57320 x 3 + 57011 x 5 + 57015
55913	1313,30	57320 x 3 + 57013 x 5 + 57014
55914	1364,90	57320 x 3 + 57014 x 10
55915	1390,00	57320 x 3 + 57014 x 5 + 57015 x
55916	1415,20	57320 x 3 + 57015 x 10

Ref	€	L (mm)	Desglose
55843	1176,50	3275	57320 x 4 + 57010 x 6 + 57012
55844	1191,60	3385	57320 x 4 + 57010 x 6 + 57013
55845	1222,50	3490	57320 x 4 + 57010 x 6 + 57014
55846	1239,80	3598	57320 x 4 + 57007 x 3 + 57014
55847	1253,80	3710	57320 x 4 + 57011 x 6 + 57014
55848	1270,40	3818	57320 x 4 + 57007 x 3 + 57015
55849	1299,60	3925	57320 x 4 + 57010 x 3 + 57014
55850	1315,00	4035	57320 x 4 + 57011 x 3 + 57014
55851	1329,70	4145	57320 x 4 + 57010 x 3 + 57015
55852	1345,70	4255	57320 x 4 + 57011 x 3 + 57015
55853	1376,30	4360	57320 x 4 + 57014 x 9
55854	1391,50	4470	57320 x 4 + 57014 x 6 + 57015
55855	1406,80	4580	57320 x 4 + 57014 x 3 + 57015
55856	1422,10	4690	57320 x 4 + 57015 x 9

Ref	€	Desglose
55880	1416,70	57320 x 4 + 57010 x 8 + 57012
55881	1436,90	57320 x 4 + 57010 x 8 + 57013
55882	1478,00	57320 x 4 + 57010 x 8 + 57014
55883	1500,30	57320 x 4 + 57007 x 4 + 57014
55884	1519,80	57320 x 4 + 57011 x 8 + 57014
55885	1541,00	57320 x 4 + 57007 x 4 + 57015
55886	1580,50	57320 x 4 + 57010 x 4 + 57014
55887	1601,60	57320 x 4 + 57011 x 4 + 57014
55888	1621,20	57320 x 4 + 57010 x 4 + 57015
55889	1641,20	57320 x 4 + 57011 x 4 + 57015
55890	1683,00	57320 x 4 + 57014 x 12
55891	1703,40	57320 x 4 + 57014 x 8 + 57015
55892	1722,70	57320 x 4 + 57014 x 4 + 57015
55893	1744,00	57320 x 4 + 57015 x 12

Ref	€	Desglose
55917	1656,70	57320 x 4 + 57010 x 10 + 57012
55918	1682,00	57320 x 4 + 57010 x 10 + 57013
55919	1732,70	57320 x 4 + 57010 x 10 + 57014
55920	1762,20	57320 x 4 + 57007 x 5 + 57014
55921	1784,90	57320 x 4 + 57011 x 10 + 57014
55922	1812,80	57320 x 4 + 57007 x 5 + 57015
55923	1861,60	57320 x 4 + 57010 x 5 + 57014
55924	1887,80	57320 x 4 + 57011 x 5 + 57014
55925	1912,50	57320 x 4 + 57010 x 5 + 57015
55926	1938,40	57320 x 4 + 57011 x 5 + 57015
55927	1990,10	57320 x 4 + 57014 x 15
55928	2015,50	57320 x 4 + 57014 x 10 + 57015
55929	2040,60	57320 x 4 + 57014 x 5 + 57015
55930	2066,00	57320 x 4 + 57015 x 15

385x1750 mm

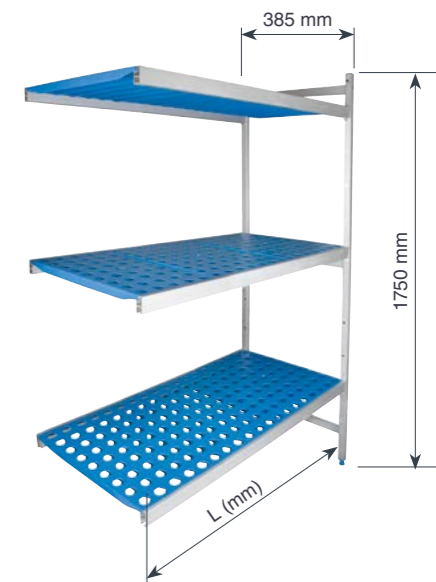

### Estantería abierta

Rayonnage ouvertes · Offenes Regale  
Open shelving · Estantes abiertas

SIMPLE

3 Estantes · Shelf			
Ref	€	L (mm)	Desglose
55631	238,30	682	56317 x 1 + 56007 x 3
55632	246,00	794	56317 x 1 + 56008 x 3
55633	261,60	904	56317 x 1 + 56009 x 3
55634	284,70	1009	56317 x 1 + 56010 x 3
55635	300,50	1119	56317 x 1 + 56011 x 3
55636	313,60	1229	56317 x 1 + 56012 x 3
55637	321,00	1339	56317 x 1 + 56013 x 3
55638	352,00	1444	56317 x 1 + 56014 x 3
55639	359,70	1554	56317 x 1 + 56015 x 3

4 Estantes · Shelf		
Ref	€	L (mm)
55640	287,30	56317 x 1 + 56007 x 4
55641	297,90	56317 x 1 + 56008 x 4
55642	318,10	56317 x 1 + 56009 x 4
55643	349,10	56317 x 1 + 56010 x 4
55644	369,90	56317 x 1 + 56011 x 4
55645	387,40	56317 x 1 + 56012 x 4
55646	397,60	56317 x 1 + 56013 x 4
55647	438,80	56317 x 1 + 56014 x 4
55648	449,10	56317 x 1 + 56015 x 4

5 Estantes · Shelf		
Ref	€	Desglose
55649	336,20	56317 x 1 + 56007 x 5
55650	349,60	56317 x 1 + 56008 x 5
55651	375,10	56317 x 1 + 56009 x 5
55652	413,70	56317 x 1 + 56010 x 5
55653	439,90	56317 x 1 + 56011 x 5
55654	461,70	56317 x 1 + 56012 x 5
55655	474,40	56317 x 1 + 56013 x 5
55656	525,80	56317 x 1 + 56014 x 5
55657	538,60	56317 x 1 + 56015 x 5

385x2000 mm



### Estantería abierta

Rayonnage ouvertes · Offenes Regale  
Open shelving · Estantes abiertas

SIMPLE

3 Estantes · Shelf			
Ref	€	L (mm)	Desglose
55658	253,40	682	56320 x 1 + 56007 x 3
55659	261,60	794	56320 x 1 + 56008 x 3
55660	276,60	904	56320 x 1 + 56009 x 3
55661	300,10	1009	56320 x 1 + 56010 x 3
55662	315,50	1119	56320 x 1 + 56011 x 3
55663	328,70	1229	56320 x 1 + 56012 x 3
55664	336,20	1339	56320 x 1 + 56013 x 3
55665	366,50	1444	56320 x 1 + 56014 x 3
55666	374,80	1554	56320 x 1 + 56015 x 3

4 Estantes · Shelf		
Ref	€	L (mm)
55667	302,30	56320 x 1 + 56007 x 4
55668	313,40	56320 x 1 + 56008 x 4
55669	333,50	56320 x 1 + 56009 x 4
55670	364,40	56320 x 1 + 56010 x 4
55671	385,10	56320 x 1 + 56011 x 4
55672	401,60	56320 x 1 + 56012 x 4
55673	412,90	56320 x 1 + 56013 x 4
55674	454,00	56320 x 1 + 56014 x 4
55675	464,20	56320 x 1 + 56015 x 4

5 Estantes · Shelf		
Ref	€	Desglose
55676	351,30	56320 x 1 + 56007 x 5
55677	364,80	56320 x 1 + 56008 x 5
55678	390,20	56320 x 1 + 56009 x 5
55679	428,90	56320 x 1 + 56010 x 5
55680	455,10	56320 x 1 + 56011 x 5
55681	477,00	56320 x 1 + 56012 x 5
55682	489,50	56320 x 1 + 56013 x 5
55683	540,90	56320 x 1 + 56014 x 5
55684	553,70	56320 x 1 + 56015 x 5

560x1750 mm



**Estantería abierta**

Rayonnage ouvertes · Offenes Regale  
Open shelving · Estantes abiertas

3 Estantes · Shelf

Ref	€	L (mm)	Desglose
55931	269,00	682	57317 x 1 + 57007 x 3
55932	276,60	794	57317 x 1 + 57008 x 3
55933	292,20	904	57317 x 1 + 57009 x 3
55934	328,70	1009	57317 x 1 + 57010 x 3
55935	343,90	1119	57317 x 1 + 57011 x 3
55936	359,70	1229	57317 x 1 + 57012 x 3
55937	374,80	1339	57317 x 1 + 57013 x 3
55938	404,10	1444	57317 x 1 + 57014 x 3
55939	420,80	1554	57317 x 1 + 57015 x 3

4 Estantes · Shelf

Ref	€	Desglose
55940	326,10	57317 x 1 + 57007 x 4
55941	336,00	57317 x 1 + 57008 x 4
55942	356,70	57317 x 1 + 57009 x 4
55943	405,20	57317 x 1 + 57010 x 4
55944	426,20	57317 x 1 + 57011 x 4
55945	445,10	57317 x 1 + 57012 x 4
55946	466,60	57317 x 1 + 57013 x 4
55947	507,80	57317 x 1 + 57014 x 4
55948	528,20	57317 x 1 + 57015 x 4

5 Estantes · Shelf

Ref	€	Desglose
55949	381,70	57317 x 1 + 57007 x 5
55950	394,50	57317 x 1 + 57008 x 5
55951	421,20	57317 x 1 + 57009 x 5
55952	481,90	57317 x 1 + 57010 x 5
55953	507,90	57317 x 1 + 57011 x 5
55954	533,50	57317 x 1 + 57012 x 5
55955	558,70	57317 x 1 + 57013 x 5
55956	610,10	57317 x 1 + 57014 x 5
55957	635,50	57317 x 1 + 57015 x 5

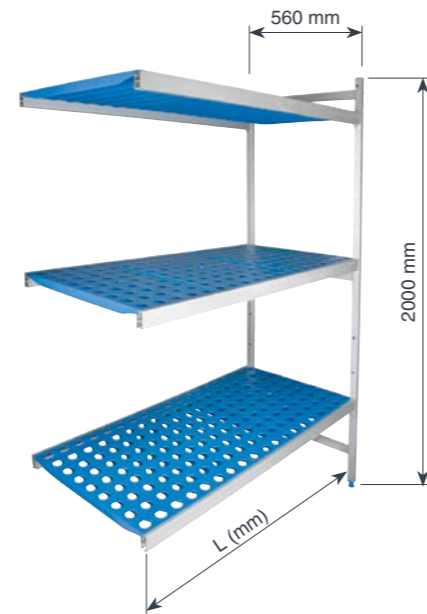

560x2000 mm

**Estantería abierta**

Rayonnage ouvertes · Offenes Regale  
Open shelving · Estantes abiertas

3 Estantes · Shelf

Ref	€	L (mm)	Desglose
55958	284,30	682	57320 x 1 + 57007 x 3
55959	291,90	794	57320 x 1 + 57008 x 3
55960	307,50	904	57320 x 1 + 57009 x 3
55961	343,60	1009	57320 x 1 + 57010 x 3
55962	359,70	1119	57320 x 1 + 57011 x 3
55963	374,80	1229	57320 x 1 + 57012 x 3
55964	389,90	1339	57320 x 1 + 57013 x 3
55965	420,80	1444	57320 x 1 + 57014 x 3
55966	436,10	1554	57320 x 1 + 57015 x 3

4 Estantes · Shelf

Ref	€	Desglose
55967	341,20	57320 x 1 + 57007 x 4
55968	351,00	57320 x 1 + 57008 x 4
55969	371,80	57320 x 1 + 57009 x 4
55970	420,50	57320 x 1 + 57010 x 4
55971	441,30	57320 x 1 + 57011 x 4
55972	461,70	57320 x 1 + 57012 x 4
55973	481,90	57320 x 1 + 57013 x 4
55974	523,00	57320 x 1 + 57014 x 4
55975	543,30	57320 x 1 + 57015 x 4

5 Estantes · Shelf

Ref	€	Desglose
55976	397,30	57320 x 1 + 57007 x 5
55977	409,90	57320 x 1 + 57008 x 5
55978	435,40	57320 x 1 + 57009 x 5
55979	497,20	57320 x 1 + 57010 x 5
55980	523,10	57320 x 1 + 57011 x 5
55981	548,40	57320 x 1 + 57012 x 5
55982	573,90	57320 x 1 + 57013 x 5
55983	625,10	57320 x 1 + 57014 x 5
55984	650,70	57320 x 1 + 57015 x 5

Organización y limpieza  
Organization and cleaning



# Cestas

PP  
Polypropylene

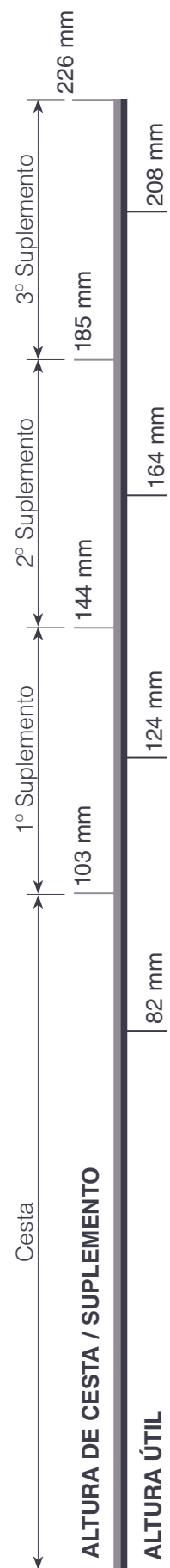

## Verificador de diametros

Vérifiez le diamètre · Chek the diameter · Diameter prufungen · Medidor de diâmetros

**49** Compart.  
Teillen

64x64 mm

**36** Compart.  
Teillen

75x75mm

**25** Compart.  
Teillen

90x90 mm

**16** Compart.  
Teillen

113x113 mm

- La alta calidad de sus materiales hacen que la resistencia al calor y a los impactos sea óptima, por lo que su durabilidad está garantizada.
- Su sistema único de apilación permite un fácil montaje, y lo que es más novedoso, el desmontaje del mismo siempre que usted lo desee.
- Su estructura abierta permite una mayor rapidez en el lavado y secado debido a una mejor circulación de agua y del aire.
- El diseño de las asas hacen que su manejo y carga sean cómodos y sin riesgos. Además, para facilitar su manejo, está disponible un carro porta cestas útil para evitar esfuerzos en los desplazamientos.
- Adaptable a la mayoría de las cestas existentes en el mercado.

- La haute qualité de ses matériaux rend la résistance à la chaleur et les impacts optimaux, donc sa durabilité est garantie.
- Son système de pile unique permet un assemblage facile, et ce qui est plus nouveau, son démontage tant que vous le souhaitez.
- Sa structure ouverte permet plus rapidement de se laver et de sécher en raison d'une meilleure circulation d'eau et d'air.
- La conception des poignées rend leur manipulation et leur charge confortable et sans risques. De plus, pour faciliter sa gestion, une voiture de panier utile est disponible pour éviter les efforts des déplacements.
- Adaptable à la plupart des paniers existants sur le marché.

- The high quality of its materials makes heat resistance and impacts optimal, so its durability is guaranteed.
- Its unique stack system allows easy assembly, and what is more new, its disassembly as long as you want.
- Its open structure allows faster to wash and dry due to a better circulation of water and air.
- The design of the handles make their handling and load comfortable and without risks. In addition, to facilitate its management, a useful basket car is available to avoid efforts in the displacements.
- Adaptable to most of the existing baskets in the market.

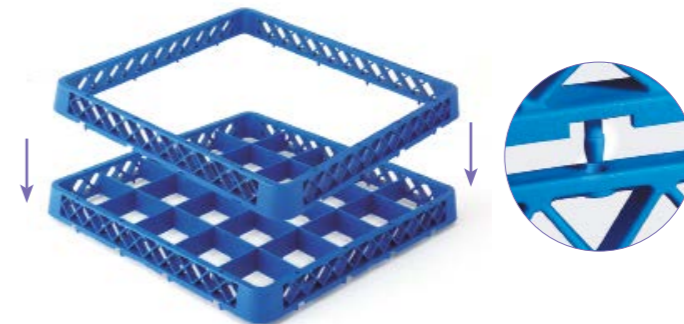

Sistema único de apilación, permite un fácil montaje  
Unique folding system enables racks to be constructed

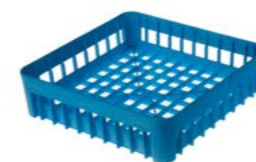

### Cesta base

Casier universel · Spülkorb  
Universal open rack · Cesta base

Ref	€	cm	U.Venta
69235	33,70	35x35x12	1
69240	34,50	40x40x11	1



### Cesta base universal

Casier universel · Universalspülkorb  
Universal open rack · Cesta base universal

Ref	€	cm	U.Venta
69250	25,60	50x50x10,3	1



### Suplemento altura abierta

Réhausse sans compart. · Ergänzung  
Universal open extender · Suplem. altura aberto

Ref	€	cm	U.Venta
69251	10,70	50x50x4,5	1



### Cesta base 16 compartimentos

Casier 16 compartiments · Spülkorb 16-tlg.  
Rack with 16 compartments · Cesta base 16 compart.

Ref	€	cm	U.Venta
69214	30,70	50x50x10,3	1



### Suplemento altura 16 compartimentos

Réhausse, 16 comp. · Ergänzung 16-tlg. Spülkorb  
Extender for rack with 16 comp.. · Suplem. altura 16 compart.

Ref	€	cm	U.Venta
69217	13,10	50x50x4,5	1



### Cesta base 25 compartimentos

Casier 25 compartiments · Spülkorb 25-tlg.  
Rack with 25 compartments · Cesta base 25 compart.

Ref	€	cm	U.Venta
69225	32,30	50x50x10,3	1



### Suplemento altura 25 compartimentos

Réhausse, 25 comp. · Ergänzung 25-tlg. Spülkorb  
Rack with 25 compart. · Suplem. altura 25 compart.

Ref	€	cm	U.Venta
69226	14,00	50x50x4,5	1



### Cesta base 36 compartimentos

Casier 36 compartiments · Spülkorb 36-tlg.  
Rack with 36 compartments · Cesta base 36 compart.

Ref	€	cm	U.Venta
69236	34,00	50x50x10,3	1



### Suplemento altura 36 compartimentos

Réhausse, 36 comp. · Ergänzung 36-tlg. Spülkorb  
Extender for rack with 36 compart. · Suplem. altura 36 compart.

Ref	€	cm	U.Venta
69237	14,00	50x50x4,5	1



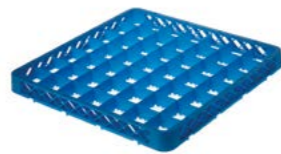

### Cesta base 49 compartimentos

Casier 49 compartiments · Spülkorb 49-tlg.  
Rack with 49 compartments · Cesta base 49 compart.

Ref	€	cm	U.Venta
69249	34,90	50x50x10,3	1

### Suplemento altura 49 compartimentos

Réhausse, 49 comp. · Ergänzung 49-tlg. Spülkorb  
Extender for rack w/49 compart. · Suplem. altura 49 compart.

Ref	€	cm	U.Venta
69248	14,80	50x50x4,5	1

### Cesta para platos

Casier pour assiettes · Tellerspülkorb  
Small trays and dishes rack · Cesta para pratos

Ref	€	cm	U.Venta
69202	25,70	50x50x10,3	1



### Cesta para platos Blue

Casier pour assiettes · Tellerspülkorb  
Small trays and dishes rack · Cesta para pratos

Ref	€	cm	U.Venta
69234	34,20	35x35x12	1
69241	40,30	40x40x11	1

### Cesta para platos/bandejas

Casier pour grands platex · Plattenspülkorb  
Universal open side trays rack · Cesta pratos/bandejas

Ref	€	cm	U.Venta
69203	31,80	50x50x10,3	1

### Cesta para cubiertos

Casier à couverts · Besteckspülkorb  
Flatware/utensil rack · Cesta para talheres

Ref	€	cm	U.Venta
69204	25,30	50x50x10,3	1



### Tapa cesta universal

Couvercle pour casier universel · Deckel für Universals Spülkorb  
Standard rack's lid · Tampa cesta universal

Ref	€	cm	U.Venta
69205	20,20	50x50x2,5	1

### Soporte para platos

Support pour les plats · Tellerhalter  
Plate holder · Suporte para pratos

Ref	€	cm	Capacidad	U.Venta
69207	10,00	31,0x9,5x7	15 platos	1
69213	11,50	34,5x9,5x7	17 platos	1



### Cesta 8 compart. Cubiertos

Panier à couverts, 8 compart. · Besteckspülkorb 8 tlg.  
Cutlery rack with 8 compart. · Cesta 8 compart. talheres

Ref	€	cm	U.Venta
69208	16,00	20,5x43x13	1



### Cubilete cubiertos

Petit panier à couverts · Besteckbehälter  
Cutlery cube · Cesta talheres

Ref	€	cm	U.Venta
69215	4,80	12,5x12,5x13,5	6



**2 ruedas con freno incorporado**  
2 wheels with built-in brakes

### Carro porta-cestas

Socle à roulettes pour casier · Transportwagen für Spuelkoerbe  
Trolley for racks · Carro porta-cestas

Ref	€	cm	L	U.Venta
69211	200,40	55x57x80	4 cestas	1
69212	122,10	55x57x20	4 cestas	1



**Sin asa**  
Without handle



# Dispensadores de jabón

## PE

Polyethylene

- Perfecto para almacenar y dispensar geles desinfectantes, jabones, champús u otros materiales líquidos.
- Tamaño compacto; ideal para oficinas, hogares, restaurantes, etc.
- Ventana transparente que permite controlar la cantidad de líquido disponible.
- Diseñado para colocar en la pared y ahorrar espacio.
- Depósito extraíble para rellenar fácilmente.

- Parfait pour stocker et distribuer des gels désinfectants, des savons, des shampoings ou d'autres matériaux liquides.
- Format compact; idéal pour les bureaux, les maisons, les restaurants, etc.
- Fenêtre transparente qui vous permet de contrôler la quantité de liquide disponible.
- Conçu pour placer sur le mur et économiser de l'espace.
- Dépôt amovible à remplir facilement.

- Perfect to store and dispense disinfectant gels, soaps, shampoos or other liquid materials.
- Compact size; Ideal for offices, homes, restaurants, etc.
- Transparent window that allows you to control the amount of liquid available.
- Designed to place on the wall and save space.
- Removable deposit to fill easily.



**Fácil de rellenar**  
Easy to fill



**Fácil de rellenar**  
Easy to fill



## SAN

Plastic

### Dispensadores de jabón/gel

Distributeur de savon et gel · Seifen- und Gelspender  
Soap and gel dispenser · Dispensador de sabão e gel

Ref	€	ml	U.Venta
A 91520	12,20	350	1
B 91521	11,10	350	1

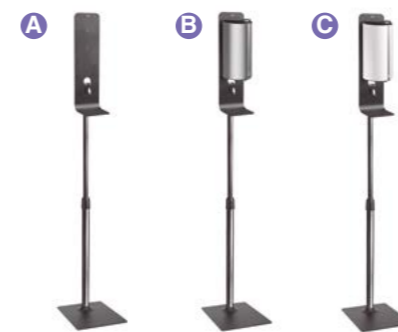

Altura regulable  
Máx: 150 cm / Min: 105 cm  
Adjustable height  
Max: 150 cm / Min: 105 cm

### Dispensador de jabón/gel White

Distributeur de savon et gel · Seifen- und Gelspender  
Soap and gel dispenser · Dispensador de sabão e gel

Ref	€	L	U.Venta
91525	24,70	1,00	1

- Permite ubicar el dispensador de gel en cualquier lugar, sin necesidad de depender de ninguna pared o superficie vertical.
- Altura regulable. Máx: 150 cm / Min: 105 cm.
- Apto para gel hidroalcohólico y jabón líquido.
- Funcionamiento con sensor, detección entre 5-9 cm de altura.
- Opción de ajustar el caudal entre 0,5 y 2,5 ml.
- Ideal para zonas de gran movimiento de gente.

- Il permet de localiser le distributeur de gel n'importe où, sans avoir besoin de dépendre d'une surface murale ou verticale.
- Hauteur réglable. Max: 150 cm / min: 105 cm.
- Convient pour le gel hydroalcoolique et le savon liquide.
- Fonctionnement du capteur, détection entre 5 à 9 cm de haut.
- Option pour ajuster le débit entre 0,5 et 2,5 ml.
- Idéal pour les zones de grand mouvement de personnes.

- It allows to locate the gel dispenser anywhere, without the need to depend on any wall or vertical surface.
- Adjustable height. Max: 150 cm / min: 105 cm.
- Suitable for hydroalcoholic gel and liquid soap.
- Sensor operation, detection between 5-9 cm high.
- Option to adjust the flow between 0.5 and 2.5 ml.
- Ideal for areas of great movement of people.

### Soporte dispensador de gel

Support distributeur de gel · Gelspenderhalter  
Gel dispenser holder · Suporte dispensador de gel

Ref	€	h(cm)	U.Venta	Fácil de rellenar
A 91540	73,00	160	1	Soporte · Support
B 91541	153,30	160	1	Plata · Silver
C 91542	153,30	160	1	Blanco · White





## Papeleras



INOX  
18/10

### Papelera sobremesa

Poubelle de table · Tisch-Abfallbehälter  
Table bin · Papeleira de mesa

Ref	€	Ø (cm)	h(cm)	L	U.Venta
63302	24,80	12	16	1,20	1



**Sistema de cierre SoftClosing**  
Cubeta interior extraíble de polipropileno con asa  
Closing system SoftClosing  
It has a removable polypropylene inner liner with a handle



**Sistema de cierre SoftClosing**  
Cubeta interior extraíble de polipropileno con asa  
Closing system SoftClosing  
It has a removable polypropylene inner liner with a handle



INOX

### Papelera con pedal

Poubelle à pédale · Tret-Abfallbehälter  
Pedal bin · Papeleira com pedal

Ref	€	Ø (cm)	h(cm)	L	U.Venta
63307	23,90	16,8	25	3,0	1



INOX

### Papalera con pedal Inox

Poubelle à pédale · Tret-Abfallbehälter  
Pedal bin · Papeleira com pedal

Ref	€	Ø (cm)	h(cm)	L	U.Venta
63303	22,70	17,0	25,5	3,0	1
63305	29,70	20,5	28,0	5,0	1
63312	43,90	25,0	40,0	12,0	1
63319	62,90	29,0	45,0	20,0	1



FE  
Iron

### Papelera con pedal Nature

Poubelle à pédale · Tret-Abfallbehälter  
Pedal bin · Papeleira com pedal

Ref	€	Ø (cm)	h(cm)	L	U.Venta
A 63335	56,30	20,5	27,6	5,0	1
B 63355	56,30	20,5	27,6	5,0	1

## Recogemigas



INOX

### Cepillo recogemigas

Ramasse-miettes à rouleaux · Krümelbürste  
Crumbs cleaner · Escova apanha-migalhas

Ref	€	cm	h(cm)	U.Venta
64407	15,10	9,5x16,5	4,0	1

INOX  
18/10

### Cepillo recogedor Hiperluxe

Ramasse-miettes à rouleaux · Krümelbürste  
Crumbs cleaner · Escova apanha-migalhas

Ref	€	cm	U.Venta
64408	51,10	14,5x17	1

INOX  
18/10

### Cepillo recogedor Luxe

Ramasse-miettes · Krümelbürste  
Crumbs cleaner · Espátula apanha-migalhas

Ref	€	cm	U.Venta
64409	31,70	22x7	1

## Portarollos de cocina

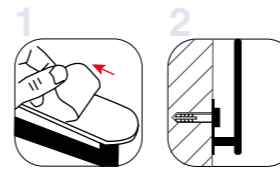

2 opciones para instalar  
2 options to install



INOX

### Portarollos de cocina Black

Dérouleur de cuisine · Küchenrollenspender  
Dispenser for kitchen · Porta-rolos cozinha

Ref	€	cm	h(cm)	U.Venta
62289	14,90	33,5x4,5	8	1



- Fabricado en acero inoxidable de alta calidad, acabado negro mate.
- Duradero y resistente, a prueba de óxido.
- Diseño moderno y elegante. Capacidad: 1 rollo de cocina (longitud de rollos: 30 cm y 6 cm de grosor).
- Perfecto para colocar el papel de cocina y mantener la encimera despejada.
- Fácil de instalar. Opción de colocar mediante papel adhesivo o perforado con tornillos (ambos incluidos).
- Se puede instalar vertical u horizontalmente según las necesidades.

- Made of high quality stainless steel, matt black finish.
- Durable and resistant, oxide proof.
- Modern and elegant design. Capacity: 1 kitchen roll (roll length: 30 cm and 6 cm thick).
- Perfect to place the kitchen and keep the countertop clear.
- Easy to install. Option to place by adhesive or perforated paper with screws (both included).
- It can be installed vertically or horizontally depending on the needs.



Perfecto para colocar el papel de cocina y mantener la encimera despejada.  
Perfect to place the kitchen and keep the countertop clear.

Base contrapeso  
Counterbalance base  
1 Kg

INOX  
18/10

### Pie portarollos

Dérouleur pour papier essuie-tout · Spänder für Küchenrolle  
Kitchen roll dispenser stand · Pé porta-rolos

Ref	€	Ø (cm)	h(cm)	U.Venta
50301	20,40	15	32,5	6



**Bobina aluminio**  
Rouleau aluminium · Aluminiumfolie  
Aluminium foil · Bobina aluminio

Ref	€	Film (m)	Micras	U.Venta
10330	<b>56,70</b>	0,30x300	11	1
10430	<b>69,70</b>	0,40x300	11	1

Rollos aptos para los portarrollos · Rolls suitable for multiroll dispenser

Ref.	Film transparente · Transparent film	Rollo aluminio · Aluminium foil	Rollo papel · Paper roll
60701	Ø50x320 mm	Ø50x320 mm	Ø180x330 mm
60702	Ø48x340 mm	Ø60x340 mm	Ø170x330 mm

INOX  
18/10

**Portarrollos de cocina pared**

Derouleur de cuisine · Küchenrollenspender  
Multiroll dispenser for kitchen · Porta-rolos cozinha de parede

Ref	€	Medidas	U.Venta
<b>A</b> 60701	<b>60,40</b>	37,7 x 30 x 8,95	6
<b>B</b> 60702	<b>56,90</b>	37,5 x 23,9 x 9,72	8



INOX

**Servilletero bar**

Distributeur de serviettes bar · Serviettenspender bar  
Bar napkin holder · Guardanapo bar

Ref	€	cm	Medidas Servilleta	U.Venta
61002	<b>9,70</b>	9,5x13,5	90x125	4

- Cuchillas de acero inoxidable intercambiables.
- Se utiliza para raspar los residuos de los alimentos y el carbón de las planchas.
- Interchangeable stainless steel blades.
- Used to scrape food and charcoal residue from grills.
- Ergonomic design with two hand-holds.



AL FUNDIDO INOX  
Aluminium Cast

**Rasqueta profesional para grill**

Racloir professionnel pour grill · Professioneller grillschaber  
Professional grill scraper · Raspador profesional para grill

Ref	€	Cuchilla (cm)	Medidas	U.Venta
67034	<b>72,60</b>	15	42x15x12 cm	1

**Bobina film transparente**

Rouleau film transparent · Frischhaltefolie  
Transparent cling film · Bobina filme transparente

Ref	€	Film (m)	Micras	U.Venta
11330	<b>14,50</b>	0,30x300	10	1
11430	<b>22,40</b>	0,45x300	10	1

- Alfombrilla escurreplatos fabricada en silicona de máxima calidad. Libre de BPA.
- Diseñada para posar la vajilla, vasos, copas, tazas, etc.
- Maximiza el drenaje y la ventilación gracias a su diseño en relieves.
- Antideslizante y antibacteriana. Fácil de limpiar y apto para el lavavajillas.
- Flexible y enrollable. Incluye un orificio para colgar.
- Resistente a altas temperaturas.

- Dish drainer mat made of top quality silicone. BPA free.
- Designed to hold crockery, glasses, cups, etc.
- Maximises drainage and ventilation thanks to its relief design.
- Anti-slip and anti-bacterial. Easy to clean and dishwasher safe.
- Flexible and rollable. Includes a hole for hanging.
- High temperature resistant.



SI Silicone Dishwasher BPA free

**Escurreplatos de silicona**

Tapis égouttoir en silicone · Abtropfmatte aus Silikon  
Silicone dish mat · Escorredor para pratos de silicona

Ref	€	cm	U.Venta
66774	<b>18,20</b>	42,5x32	1

Flexible y duradera  
Flexible and durable

# Ceniceros

INOX  
18/10

- Cenicero para pared exterior. Cerradura con llave.
- Incluye material para fijación y una llave triangular.
- Cajetín interior de acero galvanizado extraíble para facilitar su limpieza.

- Cendrier du mur extérieur. Verrouiller avec la clé.
- Comprend la fixation du matériau et une clé triangulaire.
- Acier intérieur galvanisé en acier amovible pour faciliter le nettoyage.

- Outdoor wall ashtray. Lock with key.
- Includes fixing material and a triangular key.
- Steel inner galvanized steel removable to facilitate cleaning.



Colocación en pared  
Wall mounting

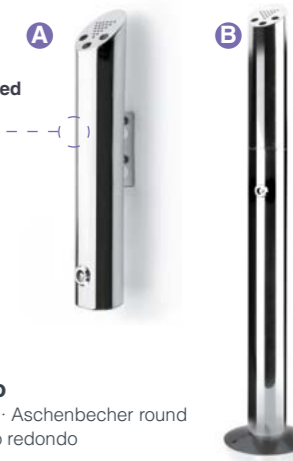

**Cenicero redondo**

Cendrier extérieur rond · Aschenbecher round  
Round ash try · Cinzeiro redondo

Ref	€	Ø (cm)	L	U.Venta
<b>A</b> 63331	<b>93,50</b>	8x46	1,70	1
R63331A	<b>4,00</b>	-	-	1
<b>B</b> 63332	<b>149,50</b>	8x92	1,50	1
R63332A	<b>4,00</b>	-	-	1

Llave Key

**Cenicero pared**

Mural cendrier · Wand aschenbecher  
Wall ash try · Cinzeiro de parede

Ref	€	cm	h(cm)	U.Venta
<b>A</b> 63341	<b>89,40</b>	24,5x35	14	1
<b>B</b> 63342	<b>83,70</b>	25x35	8,5	1

# Postes separadores Black

FE INOX  
Iron

- Ideal para la gestión de colas o separación de espacios.
- Estructura fabricada en hierro con recubrimiento de color negro.
- Cinta extensible retráctil de 2 m de longitud.
- Fácil de fijar y soltar las conexiones.

- Idéal pour la gestion des files d'attente ou la séparation des espaces.
- Structure en fer avec revêtement noir.
- Bande extensible rétractable de 2 m de long.
- Connexions faciles à fixer et à détacher.

- Ideal for queue management or space separation.
- Structure made of iron with black coating.
- Retractable extensible tape 2 m long.
- Easy to fix and release connections.

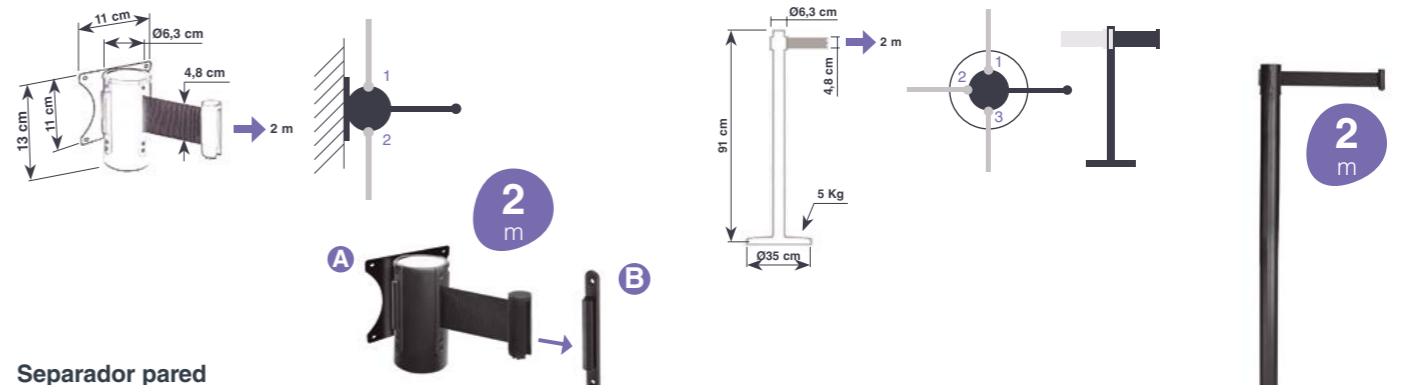

**Separador pared**

Séparateur mural · Wandtrennpfosten  
Wall separator · Separador de parede

Ref	€	Metros	U.Venta
<b>A</b> 91530	<b>37,60</b>	2	1
<b>B</b> R91533A	<b>1,80</b>	-	1

Incluye R91533A · Included)  
Apta para la ref.91533  
Suitable for ref.91533

**Poste separador**

Poteau séparateur · Trennpfosten  
Separator post · Poste separador

Ref	€	Metros	Medidas	U.Venta
91533	<b>58,40</b>	2	Ø35x91 cm	1

06

Eléctrico  
Electric





## Arroceras



Household use

- Cubeta interna extraíble con recubrimiento antiadherente 100% ECO y libre de PFOA.
- Cestillo de vapor removible para cocer verduras, patatas, pescado, etc.
- Incluye cuchara y vaso medidor.
- Tapa fabricada en vidrio con salida de vapor para evitar la cocción excesiva de los alimentos.
- Función de conservación del calor y protección contra la ebullición en seco.
- Luces indicadoras para cocinar y mantener caliente.
- 100% estable gracias a sus pies antideslizantes.
- Muy fácil de limpiar.

- Bodet interne amovible avec écho 100% et revêtement anti-tinérateur gratuit.
- Panier à vapeur amovible pour la cuisson des légumes, des pommes de terre, du poisson, etc.
- Comprend du verre à la cuillère et au compteur.
- Couvrir en verre avec une puissance à la vapeur pour éviter une cuisson alimentaire excessive.
- Fonction de conservation de la chaleur et protection contre l'ébullition à sec.
- Les voyants pour la cuisson et le respect.
- 100% stable grâce à leurs pieds non glissants.
- Très facile à nettoyer.

- Removable internal bucket with 100% echo and free anti-tinting coating.
- Removable steam basket for cooking vegetables, potatoes, fish, etc.
- Includes spoon and meter glass.
- Cover made of glass with steam output to avoid excessive food cooking.
- Heat conservation function and protection against dry boiling.
- Indicator lights for cooking and keeping hot.
- 100% stable thanks to their non-slip feet.
- Very easy to clean.

Professional use



### Arroceras

Cuiseur à riz · Reiskocher  
Rice cooker · Arrozeira/vaporeira

	Ref	€	W	Capacidad	Raciones	U.Venta
A	69441	47,00	400	1,0 L	5	1
	69233	53,90	700	1,8 L	10	1
B	69346	192,20	1300	3,6 L	20	1
	R69346F	15,30	-	-	-	1

Vaporera · Steam



## Cocedor de huevos Tri & Six Ovum



Household use

- Fabricado con base de acero inoxidable 18/10 y tapa transparente libre de BPA.
- Diseñado para cocinar huevos de diferentes tamaños y en 3 formas diferentes: huevo duro, huevo mollet o huevo pasado por agua.
- Capacidad para cocer hasta 3 huevos a la vez.
- Apagado automático y señal acústica automática al terminar el proceso de cocción.
- Incluyen un vaso medidor (70 ml) con perforador que indica la cantidad de agua que hay que introducir.
- Totalmente desmontable y muy fácil de limpiar.

- Fabriqué avec un couvercle transparent en acier inoxydable 18/10 et sans BPA.
- Conçu pour la cuisson des œufs de différentes tailles et de 3 manières différentes: œuf dur, œuf mollet ou œuf passé par l'eau.
- Capacité à cuire jusqu'à 3 œufs en même temps.
- Signal acoustique automatique et automatique à la fin du processus de cuisson.
- Ils comprennent un récipient de mesure (70 ml) avec perforateur qui indique la quantité d'eau à introduire.
- Entièrement amovible et très facile à nettoyer.

- Manufactured with 18/10 stainless steel and BPA-free transparent lid.
- Designed for cooking eggs of different sizes and in 3 different ways: hard egg, mollet egg or egg past by water.
- Capacity to cook up to 3 eggs at the same time.
- Automatic off and automatic acoustic signal at the end of the cooking process.
- They include a meter vessel (70 ml) with perforator that indicates the amount of water to be introduced.
- Fully removable and very easy to clean.



Click here



### Cocedor de huevos Tri Ovum

Cuiseur à œufs · Eierkocher  
Egg cooker · Máquina de cozer ovos

	Ref	€	W	Capacidad	Medidas	U.Venta
	69343	24,60	210	3 huevos	20x8,5x13,5 cm	1

### Cocedor de huevos Six Ovum

Cuiseur à œufs · Eierkocher  
Egg cooker · Máquina de cozer ovos

	Ref	€	W	Capacidad	Medidas	U.Venta
	69344	35,30	210	6 huevos	23,5x13x14 cm	1

# Cocedor y asador de Salchichas

INOX   Professional use

- Fabricada en acero inoxidable de alta calidad.
- Ideal para cocinar al vapor salchichas, mazorcas de maíz, etc.
- Amplia cubeta de cristal y 3 pinchos para calentar los panecillos o bollos.
- Termostato regulable. Calentamiento rápido y efectivo.
- Dos interruptores independientes para cocinar simultáneamente o por separado las salchichas y los panes.
- NO necesita aceite ni grasa.
- Pies de goma antideslizantes para una mayor estabilidad.

- Fabriqué en acier inoxydable de haute qualité.
- Idéal pour les saucisses à la vapeur, les épis de maïs, etc.
- Grand seau en verre et 3 brochettes pour chauffer les rouleaux ou les petits pains.
- Thermostat réglable. Réchauffement rapide et efficace.
- Deux commutateurs indépendants pour cuisiner simultanément ou séparément des saucisses et des pains.
- Il n'a pas besoin d'huile ou de graisse.
- Pieds en caoutchouc non glissants pour une plus grande stabilité.

- Made of high quality stainless steel.
- Ideal for steamed sausages, corn cobs, etc.
- Large glass bucket and 3 skewers to heat the rolls or buns.
- Adjustable thermostat. Fast and effective warming.
- Two independent switches to cook simultaneously or separately sausages and breads.
- It does not need oil or fat.
- Non-slip rubber feet for greater stability.



## Cocedor de salchichas

Machine à hot-dogs · Hot dog Wärmer  
Sausage cooker · Máquina de cozer salsichas

Ref	€	W	Capacidad	Altura tubos pan	Cestillo	Medidas	U.Venta
69543	476,70	540	1,0 L	18 cm	Ø17x21 cm	24x50x38,5 cm	1



## Asador de Salchichas

Grill à hot-dogs · Würstchengrill  
Sausage roaster · Assador de salsichas

Ref	€	W	Tubos	Distancia entre tubos	Medidas	U.Venta
69547	535,00	590	7 (50 cm)	1cm	65x35,5x28 cm	1



# Panificadora White

     Household use

- 12 programas y 3 niveles de tostado.
- Totalmente automática: mezcla, amasa, fermenta y hornea.
- Molde con revestimiento antiadherente extraíble de máxima calidad, ecológica y libre de PFOA.
- Programas especiales para preparar pan sin gluten, masa de pasta o pizza, etc.
- Función de mantenimiento en caliente durante 1 hora tras cada programa.
- Capacidad: 700 g o 1 KG.
- Panel de control LCD.
- Temporizador de 13 horas.
- Ventana transparente para controlar el proceso de horneado.
- Accesorios: varilla amasadora, vaso, cuchara medidora y gancho.
- Incluye libro de recetas elaborado en exclusiva para nuestra panificadora.

- 12 programmes et 3 niveaux grillés.
- Entièrement automatique: mélanger, pétrir, fermenter et cuire.
- Moule avec revêtement anti-amovible de la plus haute qualité, écologique et exempt de PFOA.
- Programmes spéciaux pour préparer du pain sans gluten, des pâtes ou de la pâte à pizza, etc.
- Fonction d'entretien à chaud pendant 1 heure après chaque programme.
- Capacité: 700 g ou 1 kg.
- Panneau de commande LCD.
- 13 -Hour temporisateur.
- Fenêtre transparente pour contrôler le processus cuit au four.
- Accessoires: pie de pie, verre, supposition de mesuration et crochement.
- Comprend un livre de recettes exclusivement préparé pour notre boulangerie.

- 12 programs and 3 toasted levels.
- Fully automatic: mix, knead, fermenta and bake.
- Mold with removable antiating coating of highest quality, ecological and free of PFOA.
- Special programs for preparing gluten-free bread, pasta or pizza dough, etc.
- Hot maintenance function for 1 hour after each program.
- Capacity: 700 g or 1 kg.
- LCD control panel.
- 13-hour timer.
- Transparent window to control the baked process.
- Accessories: kneading rod, glass, measuring spoon and hook.
- Includes recipe book exclusively prepared for our bakery.



SIN GLUTEN  
GLUTEN FREE

## Panificador White

Machine à pain · Brotbackmaschine  
Bread-making machine · Máquina de fazer pão

Ref	€	W	Capacidad	Tiempo	Funciones	Medidas	U.Venta
69334	146,60	550	1,0 L	13 horas	12	36x24,5x28 cm	1



# Yogurteras

VIDRIO Glass PP Polypropylene Healthy BPA free Cooking CE ROHS COMPLIANT Household use

- Diseñada para elaborar yogur casero de la textura y sabor que desees.
- Práctica y muy fácil de usar. Supersilenciosa.
- Tiempo de preparación de 8-14 h.
- Apagado automático con señal acústica al finalizar el proceso.
- Incluye un práctico recetario para elaborar todo tipo de yogures.

- Conçu pour faire de la texture maison et du yaourt à la saveur que vous voulez.
- Pratique et très facile à utiliser. Supersilenciosa.
- Temps de préparation de 8 à 14 h.
- Automatique avec un signal acoustique à la fin du processus.
- Il comprend un livre de recettes pratiques pour élaborer tous les types de yaourts.

- Designed to make homemade texture and flavor yogurt you want.
- Practice and very easy to use. Supersilenciosa.
- Preparation time of 8-14 h.
- Automatic off with acoustic signal at the end of the process.
- It includes a practical recipe book to elaborate all types of yogurts.



## Yogurtera de vasos Multi

Yaourtère à pots · Joghurt-Maker mit Glasbehältern  
Yoghurt maker with jars · logurteira de frascos

Ref	€	W	Capacidad	Tiempo	Medidas	U.Venta
69245	46,60	20	7 x 190 ml	1 - 14 horas	Ø25x12 cm	1



VIDRIO Glass PP Polypropylene

## Set 7 tarros Multi

Set 7 bocaux · 7-Tlg. Gläser ein  
Set 7 jars · Conjunto de 7 potes

Ref	€	Capacidad	U.Venta
69244	11,20	7x190ml	7



PP Polypropylene



## Yogurtera White

Yaourtère · Joghurt-Maker  
Yoghurt maker · logurteira

Ref	€	W	Capacidad cestillo	Capacidad jarra grande	Capacidad jarra pequeña	Medidas	U.Venta
69246	40,70	20	1 L (filtro)	1,8 L	1,6 L	18x16x24 cm	1



PP Polypropylene



## Yogurtera Maxi

Yaourtère · Joghurt-Maker  
Yoghurt maker · logurteira

Ref	€	W	Capacidad	Medidas	U.Venta
69243	41,60	20	2,0 L	Ø20x23 cm	1

PP Polypropylene



## Yogurtera Hera

Yaourtère · Joghurt-Maker  
Yoghurt maker · logurteira

Ref	€	W	Capacidad	Medidas	U.Venta
69345	39,90	20	1,0 L	Ø16,8x18,8 cm	1



## Yogurtera de vasos Deva

Yaourtère à pots · Joghurt-Maker mit Glasbehältern  
Yoghurt maker with jars · logurteira de frascos

Ref	€	W	Capacidad	Rango temperatura	Medidas	U.Venta
69439	61,80	40	170ml x 9	1-99h	26x24,6x13,5	1



VIDRIO Glass PP Polypropylene

## Set 9 tarros Deva

Set 9 bocaux · 9-Tlg. Gläser ein  
Set 9 jars · Conjunto de 9 potes

Ref	€	Capacidad	U.Venta
69438	15,80	9x170 ml	9



# Máquinas de helado

INOX  
18/10



Household use

- Una nueva forma de hacer helados cremosos y saludables.
- Puedes realizar infinidad de helados; fresa, plátano, kiwi, mango, piña, melón, etc.
- Ideal para dietas especiales: sin leche, sin azúcar, sin gluten.

- Une nouvelle façon de faire de la crème glacée crémeuse et saine.
- Vous pouvez effectuer d'innombrables glaces; Fraise, banane, kiwi, mangue, ananas, melon, etc.
- Idéal pour les régimes spéciaux: sans lait, sans sucre, sans gluten.

- A new way of doing creamy and healthy ice cream.
- You can perform countless ice cream; Strawberry, banana, kiwi, mango, pineapple, melon, etc.
- Ideal for special diets: without milk, without sugar, gluten without.



## Corta vegetales + Máquina de helado Cosmo

Hachoir légumes + machine à fruitcreme glaciee · Gemüseschneider + Obst-Eis machine  
Vegetables cutter + ice fruit machine · Corta vegetales + máq. de helado de fruta

Ref	€	W	Cuchillas	Medidas	U.Venta
69115	82,50	150	6	24,5x22,5x19,5 cm	1



Accesorio para helado de frutas  
Fruit ice cream accessory

2 en 1

5 cuchillas de colores  
5 colored blades



new



- Fabricada en acero inoxidable de gran calidad.
- Equipado con un potente compresor profesional de 150 W que permite preparar helado sin pre-congelar previamente el recipiente o los ingredientes.
- Versátil: Diseñado para elaborar helado, sorbete, yogur helado, etc. Personaliza tus recetas al 100%.
- Contenedor térmico extraíble fabricado en aluminio y capacidad de 1,5L.
- Función COOL: mantiene el helado frío durante una hora después de terminar el proceso.
- Intuitivo y sencillo de usar. Regula el tiempo de preparación de 5 a 90 minutos.
- Tapa transparente con un orificio para controlar el proceso o añadir ingredientes sin necesidad de abrir la heladera.
- Incorpora 2 paletas de mezcla especializadas para conseguir la textura idónea.
- Fácil limpieza: Todos los componentes de fabricación son desmontables, lo que permite una limpieza individual. Los accesorios son extraíbles y la tapa y las palas se pueden lavar en el lavavajillas.

- Equipped with a powerful 150 W professional compressor which allows you to prepare ice cream without pre-freezing the container or ingredients beforehand.
- Versatile: Designed to make ice cream, sorbet, frozen yoghurt, etc. Customise your recipes 100%.
- Removable thermal container made of aluminium with a capacity of 1.5L.
- COOL function: keeps the ice cream cold for one hour after the process is finished.
- Intuitive and easy to use. Regulates the preparation time from 5 to 90 minutes.
- Transparent lid with a hole to control the process or add ingredients without opening the ice cream maker.
- Incorporates 2 specialised mixing paddles to achieve the ideal texture.
- Easy cleaning: All manufacturing components are removable, allowing individual cleaning. The accessories are removable and the lid and blades are dishwasher safe.

## Máquina de helados Artic

Machine de crème glacée · Eis Maschine  
Ice cream machine · Máquina degelado

Ref	€	W	Capacidad	Rango temperatura	Medidas	U.Venta
69306	390,60	150	1,50 L	Hasta -25°C	43x29x24 cm	1



Incluye  
cuchara medidora  
Measuring spoon  
included

Sistema de  
cocción por aire  
caliente  
Hot air cooking  
system

Sin aceite  
Without Oil

# Palomitera

PC  
Polycarbonate



Household use

- Prepara palomitas saludables sin necesidad de utilizar aceite, gracias a su sistema de cocción por aire caliente.
- Palomitas recién hechas en tan solo 3 minutos.
- Capaz de cocinar hasta 80 g de maíz por cada ciclo de trabajo.
- Incluye cuchara medidora para el maíz que te ayudará a calcular las raciones.
- Interruptor de encendido / apagado. Pies antideslizantes.

- Préparez du pop-corn sain sans utiliser d'huile, grâce à son système de cuisson à l'air chaud.
- Je viens de faire du pop-corn en seulement 3 minutes.
- Capable de cuisiner jusqu'à 80 g de maïs pour chaque cycle de travail.
- Comprend une cuillère de mesure pour le maïs qui vous aidera à calculer les parties.
- Interrupteur d'allumage / désactivé. Pieds non glissants.

- Prepare healthy popcorn without using oil, thanks to its hot air cooking system.
- Just made popcorn in just 3 minutes.
- Capable of cooking up to 80 g of corn for each work cycle.
- Includes a measurement spoon for corn that will help you calculate the portions.
- Ignition / off switch. Non -slip feet.



## Palomitera

Machine à pop-corn · Popcorn-Maschine  
Popcorn maker · Máquina de fazer pipocas

Ref	€	W	Capacidad	Medidas	U.Venta
69299	39,50	1000	80g	14,5x21,5x30 cm	1



# Batidoras amasadoras



- **Batir, mezclar y amasar productos para la preparación de alimentos.**
- **Velocidad regulable, doble movimiento de giro, rotativo y orbital.**
- **Brazo basculante para acoplar los distintos accesorios.**

- Battre, mélanger et pétrir les produits pour la préparation des aliments.
- Vitesse réglable, double virage, mouvement rotatif et orbital.
- Slipping ARM pour fixer les différents accessoires.

- Beat, mix and knead products for food preparation.
- Adjustable speed, double turn, rotating and orbital movement.
- Slipping arm to attach the different accessories.



## Batidora amasadora Profesional

Batteur pétrisseur · Mix- und Knetmaschine  
Mixer-kneader · Batedeira amassadora

Ref	€	W	Capacidad	Velocidad	Niveles potencia	Medidas	U.Venta
69084	888,10	300	5,0 L	130-850 rpm	3	24x36,5x41,5 cm	1

- **Regulador de velocidad para 6 velocidades y función PULSE (Turbo).**
- **Amasado con movimientos planetarios. Doble movimiento de giro, rotatorio y orbital.**
- **Brazo basculante de 35° para acoplar los distintos accesorios.**
- **Tapa transparente anti-salpicaduras con ventana para añadir ingredientes durante el uso**

- Régulateur de vitesse pour 6 vitesses et fonction d'impulsion (Turbo).
- Pétrifié avec des mouvements planétaires. Double virage, mouvement rotatif et orbital.
- 35° Bran incliné pour fixer les différents accessoires.
- Couvercle anti-apphine transparent avec fenêtre pour ajouter des ingrédients pendant l'utilisation

- Speed regulator for 6 speeds and Pulse function (turbo).
- Kneaded with planetary movements. Double turn, rotary and orbital movement.
- 35° tilting arm to attach the different accessories.
- Transparent anti-sapphire cover with window to add ingredients during use



## Batidora amasadora Gourmet

Batteur pétrisseur · Mix- und Knetmaschine  
Mixer-kneader · Batedeira amassadora

Ref	€	W	Capacidad	Velocidad	Niveles de velocidad	Medidas	U.Venta
69388	217,30	600	4,0 L	60-180 rpm	6	22x35x30 cm	1

Professional use



- **5 velocidades ajustables con función turbo y sistema de rotación planetaria.**
- **Mecanismo de engranajes metálicos.**
- **Bol de acero inoxidable de 5 L de máxima calidad.**
- **Tapa transparente anti salpicaduras con ventana.**

- 5 adjustable speeds with turbo function and planetary rotation system.
- Metal gear mechanism.
- 5 L's stainless steel bowl.
- Transparent anti splashes with window.



## Batidora amasadora Delicy

Batteur pétrisseur · Mix- und Knetmaschine  
Mixer-kneader · Batedeira amassadora

Ref	€	W	Capacidad	Velocidad	Velocidad amasadora	Medidas	U.Venta
69583	364,50	1000	5,0 L	5 niveles	130-540 rpm	25x32,5x36,5 cm	1

- **Ruleta de velocidad integrada: 6 velocidades ajustables con función turbo y sistema de rotación planetaria.**
- **Mecanismo de engranajes metálicos.**
- **Bol de acero inoxidable de 6 L de máxima calidad.**
- **Tapa transparente anti salpicaduras con ventana.**

- Integrated speed roulette: 6 adjustable speeds with turbo function and planetary rotation system.
- Metal gear mechanism.
- 6 L stainless steel bowl.
- Transparent anti splashes with window.



## Batidora amasadora Complet

Batteur pétrisseur · Mix- und Knetmaschine  
Mixer-kneader · Batedeira amassadora

Ref	€	W	Capacidad	Velocidad	Velocidad amasadora	Medidas	U.Venta
69683	392,50	1500	6,0 L	6 niveles	117-606 rpm	25,5x40x33,5 cm	1

Household use



Semiprofessional use



## Accesorios . Accessories

VIDRIO INOX  
Glass

### Accesorio jarra

Accessoire cruche · Krugzubehör  
Jug accessory · Acessório de jarro

Ref	€	U.Venta
69584	27,90	1
69684	27,90	1



INOX

### Accesorio Picadora/embudidora/kibbe

Accessoire hachoir/stuffer/kibbe · Fleischwolf/Wurstfüller/Kibbe Zubehör  
Chopper/stuffer/kibbe accessory · Acessório picador/stuffer /kibbe

Ref	€	Cuchillas	U.Venta
69685	59,20	4	1



# Batidos y cócteles

INOX    Professional use



- Batidora profesional.
  - Ideal para elaborar batidos y cócteles.
  - Con interruptor de velocidad y enganche para vaso batidor.
- Blender professionnel.
  - Idéal pour faire des milkshakes et des cocktails.
  - Avec un interrupteur de vitesse et un attelage pour fouetter du verre.
- Professional blender.
  - Ideal to make milkshakes and cocktails.
  - With speed switch and hitch for whipping glass.

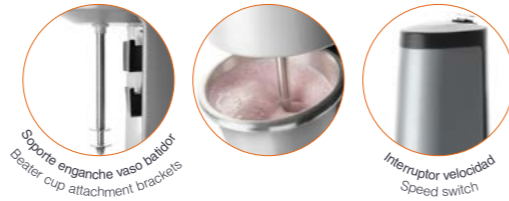

## Batidora cóctel

Batteur · Mixer  
Blender · Batedeira

Ref	€	W	Capacidad	Velocidad	Medidas	U.Venta
69111	290,00	400 W	0,6 L	10000 - 15000 rpm	21x15x51 cm	1



# Batidores de varillas

INOX     Household use

- Ideal para batir, mezclar y amasar fácilmente todo tipo de preparaciones reposteras de manera fácil y eficiente.
  - Potente, silencioso y ligero para una mayor comodidad durante el uso.
  - Empuñadura ergonómica; permite realizar la mezcla de manera segura y firme.
  - Incluye 2 varillas batidoras y 2 varillas amasadoras.
  - Extrae las varillas fácilmente con el botón de expulsión.
- Idéal pour battre, mélanger et pétrir toutes sortes de préparations de manière facile et efficace.
  - Puissant, silencieux et léger pour un plus grand confort lors d'une utilisation.
  - Poignée ergonomique; Il vous permet d'effectuer le mélange en toute sécurité et de partir.
  - Comprend 2 tiges de fouet et 2 tiges de pétrissage.
  - Extraire facilement les tiges avec le bouton d'expulsion.
- Ideal to beat, easily mix and knead all kinds of preparations in an easy and efficient way.
  - Powerful, silent and light for greater comfort during use.
  - Ergonomic handle; It allows you to perform the mixture safely and go.
  - Includes 2 whipping rods and 2 kneading rods.
  - Extract the rods easily with the expulsion button.



## Batidora de varillas Home

Batteur à main · Handmixer  
Hand mixer · Batedor de mão

Ref	€	W	Velocidad	Medidas	U.Venta
69384	48,40	300	5 + TURBO	18x8x14 cm	1

## Batidora de varillas TitanPro

Batteur à main · Handmixer  
Hand mixer · Hand mixer

Ref	€	W	Velocidad	Medidas	U.Venta
69374	54,30	350	5 + TURBO	14,5X8,5X19 cm	1

Display incorporado; indica la velocidad seleccionada y el tiempo de uso  
The built-in display shows the selected speed and usage time





# Batidora Profesional Brisk



Professional use

- Fabricado en materiales altamente resistentes y de máxima calidad.
- El mango ergonómico ofrece mayor seguridad y control de la batidora.
- Indicado para trabajar en ollas de hasta 10 litros de capacidad.
- Los brazos trituradores, batidores y cuchillas, fabricados en acero inoxidable.
- Colocación y desmontaje sencillo e instantáneo, sin necesidad de utilizar herramientas.
- Prepara purés, cremas y todo tipo de salsas.

- Fabriqué dans des matériaux de qualité très résistants et maximaux.
- La mangue ergonomique offre une plus grande sécurité et contrôle du mélangeur.
- Indiqué pour fonctionner dans des pots pouvant atteindre 10 litres de capacité.
- Bras, baigneurs et lames écrasants, en acier inoxydable.
- Placement et démontage simple et instantané, sans utiliser d'outils.
- Préparez les purées, les crèmes et toutes sortes de sauces.

- Manufactured in highly resistant and maximum quality materials.
- The ergonomic mango offers greater security and control of the blender.
- Indicated to work in pots of up to 10 liters of capacity.
- Crushing arms, bathers and blades, made of stainless steel.
- Placement and simple and instant disassembly, without using tools.
- Prepare purees, creams and all kinds of sauces.

Botón de uso continuo  
Continuous use button



Regulador de velocidad variable  
Variable speed controller



Brazo de fácil desmontaje en acero inoxidable  
Easy to remove arm made of stainless steel



Cuchilla de gran calidad para un óptimo trabajo  
High-quality blade for optimum work

## Serie 270



### Batidor velocidad fija

Mixer vitesse fixe · Profi-mixer, Festdrehzahl  
Immersion blender fixed speed · Batedeira velocidade fixa

Ref	€	W	Velocidad	Capacidad	U.Venta
69722	237,10	270	20000 rpm	10 L	1



### Batidor velocidad variable

Mixer vitesse variable · Profi-mixer, variable Geschwindigkeit  
Immersion blender variable speed · Batedeira velocidade variável

Ref	€	W	Velocidad	L	U.Venta
69723	253,50	270	4000 - 20000 rpm	10 L	1



### Brazo triturador

Pied mixeur · Rohr  
Shaft tube · Pé triturador

Ref	€	Largo (cm)	U.Venta
69816	120,60	16	1



### Set de llaves desmontaje cuchillas

Outil demontage lame set · Schüsselsatz zum Wechseln der Messer  
Blade disassembly tool set · Set ferrament desmontagem lâmina

Ref	€	U.Venta
R69722J	11,20	1



### Brazo batidor

Fouet mélangeur · Rührbesen  
Whisk · Pé amassadora

Ref	€	Largo (cm)	U.Venta
69815	168,50	18,5	1



### Soporte batidora Brisk

Support mélangeur · Aufhängeleiste für Mixer  
Blender stand · Suporte para batedeira

Ref	€	Diámetro varilla (mm)	h(cm)	Largo (cm)	U.Venta
A 69801	9,00	5,0	5,5	7	1 Individual
B 69803	17,00	5,0	5,5	28	1 Triple

# Serie 350

## Batidor velocidad fija



### Batidor velocidad fija

Mixer vitesse fixe · Profi- mixer, Festdrehzahl  
Immersion blender fixed speed · Batedeira velocidade fixa

	Ref	€	W	Velocidad (r.p.m.)	Capacidad	Medidas Brazo (cm)	Composición	U.Venta
A	69761	309,70	350 W	16000	15 L	20	69735 + 69820	1
B	69762	322,80	350 W	16000	20 L	25	69735 + 69825	1
C	69763	335,70	350 W	16000	30 L	30	69735 + 69830	1
D	69764	355,10	350 W	16000	80 L	40	69735 + 69840	1
E	69765	380,80	350 W	16000	120 L	50	69735 + 69850	1

## Batidor velocidad variable

Regulador de velocidad variable  
Variable speed controller



### Batidor velocidad variable

Mixer vitesse fixe · Profi- mixer, Festdrehzahl  
Immersion blender fixed speed · Batedeira velocidade fixa

	Ref	€	W	Velocidad (r.p.m.)	Capacidad	Medidas Brazo (cm)	Composición	U.Venta
A	69771	326,70	350 W	4,000-16,000	15 L	20	69736 + 69820	1
B	69772	339,60	350 W	4,000-16,000	20 L	25	69736 + 69825	1
C	69773	352,50	350 W	4,000-16,000	30 L	30	69736 + 69830	1
D	69774	371,70	350 W	4,000-16,000	80 L	40	69736 + 69840	1
E	69775	397,50	350 W	4,000-16,000	120 L	50	69736 + 69850	1

# Serie 500

## Batidor velocidad fija



### Batidor velocidad fija

Mixer vitesse fixe · Profi- mixer, Festdrehzahl  
Immersion blender fixed speed · Batedeira velocidade fixa

	Ref	€	W	Velocidad (r.p.m.)	Capacidad	Medidas Brazo (cm)	Composición	U.Venta
A	69781	327,40	500 W	16,000	30 L	20	69750 + 69820	1
B	69782	340,40	500 W	16,000	40 L	25	69750 + 69825	1
C	69783	353,30	500 W	16,000	60 L	30	69750 + 69830	1
D	69784	372,50	500 W	16,000	100 L	40	69750 + 69840	1
E	69785	398,30	500 W	16,000	140 L	50	69750 + 69850	1

## Batidor velocidad variable

Regulador de velocidad variable  
Variable speed controller



### Batidor velocidad variable

Mixer vitesse fixe · Profi- mixer, Festdrehzahl  
Immersion blender fixed speed · Batedeira velocidade fixa

	Ref	€	W	Velocidad (r.p.m.)	Capacidad	Medidas Brazo (cm)	Composición	U.Venta
A	69791	342,30	500 W	4,000-16,000	30 L	20	69751 + 69820	1
B	69792	355,20	500 W	4,000-16,000	40 L	25	69751 + 69825	1
C	69793	368,00	500 W	4,000-16,000	60 L	30	69751 + 69830	1
D	69794	387,30	500 W	4,000-16,000	100 L	40	69751 + 69840	1
E	69795	413,10	500 W	4,000-16,000	140 L	50	69751 + 69850	1

# Accesorios



## Motor batidor serie 350

Moteur mixer SÉRIE 350 · Mixer Motor, SERIE 350  
Immersion blender motor, SERIE 350 · Motor bateadeira SÉRIE 350

Ref	€	W	U.Venta
69735	174,60	350	1 <b>Velocidad Fija</b> · Fixed Speed
69736	191,30	350	1 <b>Velocidad Variable</b> · Variable Speed



## Motor batidor serie 500

Moteur mixer SÉRIE 500 · Mixer Motor, SERIE 500  
Immersion blender motor SERIE 500 · Motor bateadeira SÉRIE 500

Ref	€	W	U.Venta
69750	192,00	500	1 <b>Velocidad Fija</b> · Fixed Speed
69751	206,90	500	1 <b>Velocidad Variable</b> · Variable Speed

## Brazo triturador

Pied mixeur · Rohr  
Shaft tube · Pé triturador

Ref	€	Largo (cm)	A (cm)	U.Venta
<b>A</b> 69820	135,40	20	12,5	1
<b>B</b> 69825	148,40	25	15,8	1
<b>C</b> 69830	161,10	30	19,2	1
<b>D</b> 69840	180,40	40	25,8	1
<b>E</b> 69850	206,20	50	32,5	1
<b>F</b> 69824	187,00	25	-	1

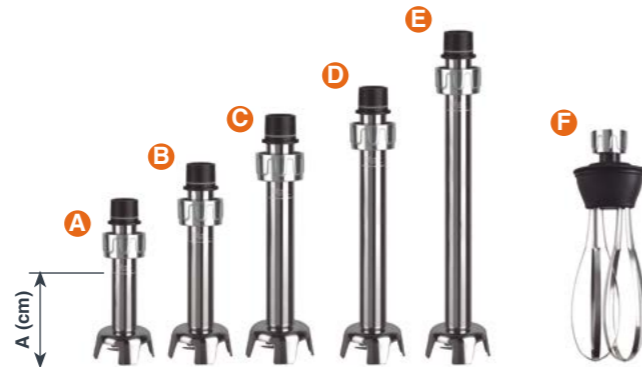

## Set llaves desmontaje cuchillas

Outil démontage lame set · Schüsselsatz zum Wechseln der Messer  
Blade disassembly tool set · Set ferrament desmontagem lâmina

Ref	€	U.Venta
R69735J	11,20	1



## Soporte batidora Brisk

Support mélangeur · Aufhängeleiste für Mixer  
Blender stand · Suporte para bateadeira

Ref	€	Diámetro varilla (mm)	h(cm)	Largo (cm)	U.Venta
<b>A</b> 69801	9,00	5,0	5,5	7	1 Individual
<b>B</b> 69803	17,00	5,0	5,5	28	1 Triple



# Batidora profesional Rapid

new

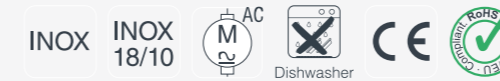

Professional use

- Batidora profesional con brazo triturador.
  - Fabricado en materiales altamente resistentes y de máxima calidad.
  - El mango ergonómico ofrece mayor seguridad y control de la batidora.
  - Indicado para trabajar en ollas de hasta 8 litros de capacidad.
  - El brazo triturador y cuchillas, fabricados en acero inoxidable.
  - Colocación y desmontaje del brazo sencillo e instantáneo, sin necesidad de utilizar herramientas.
  - Facilidad de limpieza.
  - Prepara purés (verduras, patatas, potajes, etc.), cremas (cebolla, pimientos, tomate, pastelería, etc.) y todo tipo de salsas.
- Mixeur professionnel avec bras de mixage.
  - Fabriqué avec des matériaux hautement résistants et d'une qualité maximale.
  - Le manche ergonomique offre une sécurité et un contrôle accrus du mixeur.
  - Indiqué pour travailler dans des marmites de jusqu'à 8 litres de contenance.
  - Accessoires pour hacher e couper, fabriqués en acier inoxydable.
  - Installation et démontage des accessoires simple et instantané, sans utilisation d'outils supplémentaires.
  - Nettoyage facile.
  - Permet de préparer des purées (légumes, pommes de terre, soupes, etc.), des crèmes (oignons, poivrons, tomates, crème pâtissière, etc.) et tout type de sauces.
- Professional blender with blending arm.
  - Made from highly resistant materials of the highest quality.
  - The ergonomic handle provides greater safety and control of the blender.
  - Suitable for working in pots up to 8 litres.
  - The shredder, beater and blades are made of stainless steel.
  - Fitting and removing the arms is simple and instant, without using tools.
  - Easy to clean.
  - Prepare soups (vegetable, potato, broth, etc.), purées (onion, peppers, tomatoes, custard, etc.) and all kinds of sauces.

## Serie 220



### Batidor Rapid

Mixer Professional · Professionellen Stabmixer  
Professional mixer · Bateadora Profissional

Ref	€	W	Velocidad (r.p.m.)	Capacidad	U.Venta
69920	185,80	220	4000-18000	8 L	1

## Serie 228



### Serie 280W

Serie 280W · 280W-Serie  
280W Series · Série 280W

Ref	€	W	Velocidad (r.p.m.)	Capacidad	Medidas Brazo (cm)	U.Venta
69929	339,00	280	6000-20000	10L	24	1

## Serie 450

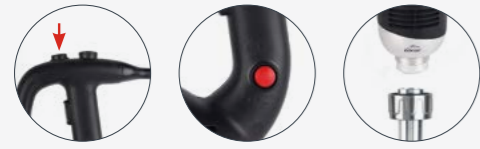

Ref	€	W	Velocidad (r.p.m.)	Capacidad	Medidas Brazo (cm)	Composición	U.Venta
<b>A</b> 69905	<b>438,40</b>	450	4000-16000	30 L	25	69946 + 69925	1
<b>B</b> 69906	<b>447,40</b>	450	4000-16000	50 L	30	69946 + 69930	1
<b>C</b> 69907	<b>465,60</b>	450	4000-16000	100 L	40	69946 + 69940	1

## Serie 650

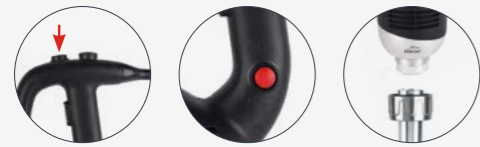

Ref	€	W	Velocidad (r.p.m.)	Capacidad	Medidas Brazo (cm)	Composición	U.Venta
<b>A</b> 69932	<b>478,20</b>	650	8000-18000	80 L	30	69966 + 66930	1
<b>B</b> 69933	<b>496,40</b>	650	8000-18000	140 L	40	69966 + 69940	1
<b>C</b> 69934	<b>514,60</b>	650	8000-18000	180 L	50	69966 + 69950	1
<b>D</b> 69935	<b>523,90</b>	650	8000-18000	220 L	55	69966 + 69955	1

## Serie 850

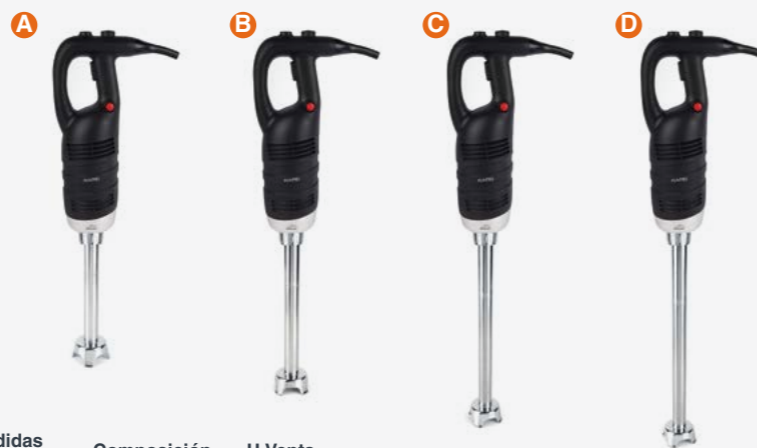
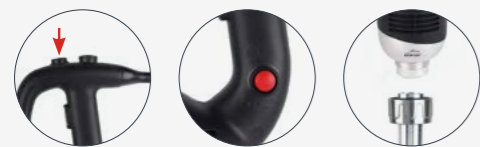

Ref	€	W	Velocidad (r.p.m.)	Capacidad	Medidas Brazo (cm)	Composición	U.Venta
<b>A</b> 69976	<b>509,00</b>	850	8000-18000	100 L	30	69986 + 69930	1
<b>B</b> 69977	<b>527,20</b>	850	8000-18000	160 L	40	69986 + 69940	1
<b>C</b> 69978	<b>545,40</b>	850	8000-18000	200 L	50	69986 + 69950	1
<b>D</b> 69979	<b>554,70</b>	850	8000-18000	240 L	55	69986 + 69955	1

## Accesorios



### Motor batidor Rapid

Mixer Professional - Profi-Mixer  
Professional mixer - Batedora Profissional

Ref	€	W	Velocidad (r.p.m.)	U.Venta
<b>A</b> 69946	<b>256,80</b>	450	4000-16000	1
<b>B</b> 69966	<b>287,60</b>	650	8000-18000	1
<b>C</b> 69986	<b>318,50</b>	850	8000-18000	1

### INOX 18/10

#### Brazo triturador Rapid

Pied mixeur - Rohr  
Shaft tube - Pé triturador

Ref	€	h(cm)	A (cm)	U.Venta
<b>A</b> 69916	<b>152,00</b>	24	15	1
<b>B</b> 69925	<b>181,50</b>	25	17	1
<b>C</b> 69930	<b>190,60</b>	30	20	1
<b>D</b> 69940	<b>208,70</b>	40	27	1
<b>E</b> 69950	<b>226,90</b>	50	35	1
<b>F</b> 69955	<b>236,30</b>	55	38	1
<b>F</b> 69918	<b>195,10</b>	18,5	-	1
<b>G</b> 69926	<b>192,80</b>	25	-	1



# Bamix

INOX  
18/10



Professional use

- Permite montar, batir, mezclar, triturar y picar todo tipo de frutas y verduras, así como picar hielo, gracias a sus cuchillas.
- Batidora de precisión y alta calidad.
- Permite trabajar con ella largo tiempo sin que se caliente.
- Mango diseñado para adaptarse a la mano.
- 2 posiciones: I : se utiliza con cantidades pequeñas, para preparados ligeros y esponjosos. II : se usa para cantidades más grandes e ingredientes viscosos y consistentes.

- Il permet d'assembler, de battre, de mélanger, d'écraser et de hacher toutes sortes de fruits et légumes, ainsi que de hacher de la glace, grâce à leurs lames.
- Blender de précision et de haute qualité.
- Vous permet de travailler avec elle pendant longtemps sans chaud.
- Mango conçu pour s'adapter à la main.
- 2 positions: I: Il est utilisé avec de petites quantités, pour des préparations légères et duveteées. II: Il est utilisé pour des quantités plus importantes et des ingrédients visqueux et cohérents.

- It allows to assemble, beat, mix, crush and chop all kinds of fruits and vegetables, as well as chop ice, thanks to their blades.
- Precision and high quality blender.
- Allows you to work with her for a long time without hot.
- Mango designed to adapt to hand.
- 2 Positions: I: It is used with small amounts, for light and fluffy preparations. II: It is used for larger amounts and viscous and consistent ingredients.



## Cuchilla para carne

lame à viande · Klinge für Fleisch  
Blade for meat · Lâminar para carne

Ref	€	U.Venta
R61672D	20,70	1



## Set pulverizador

Broyeur · Mahleinheit  
Pulverizing unit · Conjunto pulverizador

Ref	€	ml	U.Venta
61674	48,60	250	1



## Set cortador

Combiné râpeur · Schneide-/Zubereitungseinheit  
Cutting/preparing unit · Conjunto cortador

Ref	€	ml	U.Venta
61675	199,50	500	1



## Batidora Bamix

Mixer · Mixer  
Mixer · Batedeira

Ref	€	W	h (cm)	Velocidad	Inmersión	U.Venta
61672	339,40	200 W	39,5	14000-18000 rpm	25 cm	1
61673	530,20	350 W	49,5	18000-22000 rpm	35 cm	1



# Provite

new

INOX



Professional use

- Batidora de precisión y de alta calidad. Potente y eficaz.
- Resultados extraordinarios: cortar, picar, triturar, mezclar, batir, montar o emulsionar cualquier preparación.
- Mango ergonómico, permite una sujeción perfecta y garantiza un fácil manejo.
- Incluye tres cuchillas intercambiables de acero inoxidable de máxima calidad, un soporte y llave para cambiar las cuchillas.
- Sistema anti-salpicaduras.
- Pie batidor fabricado en acero inoxidable de gran calidad.

- Mixeur de précision et de grande qualité. Puissant et efficace.
- Résultats extraordinaires : couper, hacher, mixer, mélanger, battre ou émulsionner tout type de préparations.
- Manche ergonomique qui permet une prise en main parfaite et garantit une manipulation aisée.
- Inclut trois lames interchangeables en acier inoxydable de la plus grande qualité, un support et une clé pour les changer.
- Système anti-éclaboussures.
- Pied fabriqué en acier inoxydable de grande qualité.
- Nettoyage facile. Il est important que la partie supérieure où se trouve le moteur ne soit pas en contact direct avec de l'eau.

- Top-quality, high-precision hand blender. Powerful and efficient.
- Exceptional results: ideal for cutting, chopping, grinding, mixing, beating, whipping or emulsifying mixtures of any kind.
- Ergonomic handle for a perfect grip and easy handling.
- Includes three high-quality stainless steel interchangeable blades, a support and a tool to change them.
- Anti-splash system.
- High-quality stainless steel blender arm.
- Easy to clean.
- Warning: the upper part where the motor is located must not come into direct contact with water.

## Provite

Mixer · Mixer  
Mixer · Batedeira

Ref	€	W	Velocidad (r.p.m.)	Ø (cm)	h (cm)	U.Venta
61664	150,80	170	22000	6,3	34	1



# Batidora Fast

INOX 18/10 BPA free Dishwasher DC CE Household use



Cuchillas exclusivas de alto rendimiento  
Exclusive high performance blades

**Batidora Fast**  
Mixeur · Mixer  
Blender · Batedeira

	Ref	€	W	Velocidad	Capacidad vaso	Medidas	U.Venta
A	61681	77,00	700	9000-16000 rpm	500	14,5 x 14,5 x 40,5 cm	1
B	61671	87,90	700	9000-16000 rpm	500	14,5 x 14,5 x 40,5 cm	1

# Premium

BPA free Dishwasher AC CE Household use



Botón de bloqueo  
Regulador de velocidad  
Lock button  
Speed regulator button



Cuchillas afiladas  
Antisalpicaduras  
Sharp blades  
Anti-splash housing

**Batidora Premium**  
Mixer · Mixer  
Mixer · Batedeira

	Ref	€	W	Velocidad	Capacidad vaso	Medidas	U.Venta
	61678	65,40	1000	16000 rpm	800 ml	5,5x6,5x41 cm	1

# Pro

INOX 18/10 BPA free Dishwasher DC CE Household use



**Batidora Pro**  
Mixer · Mixer  
Mixer · Batedeira

	Ref	€	W	Velocidad	Capacidad vaso	Medidas	U.Venta
A	61682	70,60	1000	13000-16000 rpm	800 ml	41x6,5x6,5 cm	1
B	61683	78,90	1000	13000-16000 rpm	800 ml	41x6,5x6,5 cm	1

# Mix

INOX 18/10 BPA free Dishwasher DC CE Household use



Regulador de velocidad  
Speed regulator



Cuchillas afiladas  
Sharp blades

**Batidora Mix**  
Mixer · Mixer  
Mixer · Batedeira

	Ref	€	W	Velocidad	Capacidad vaso	Medidas	U.Venta
	61679	62,60	1200	13000 - 15300 rpm	800 ml	41x6,5x6,5 cm	1



**Picadora Fast**  
Hachoir · Fleischwolf  
Mincer · Picadora

	Ref	€	ml	U.Venta
	R61671A	12,60	750	1



**Batidor varillas Premium**  
Fouet multibrins · Schneebesen  
Wire whisk · Batedeira varetas

	Ref	€	Largo (cm)	U.Venta
	R61678L	5,70	23	1



**Picadora Premium**  
Hachoir · Fleischwolf  
Mincer · Picadora

	Ref	€	ml	U.Venta
	R61678K	11,10	500	1



**Batidor varillas Pro**  
Fouet multibrins · Schneebesen  
Wire whisk · Batedeira varetas

	Ref	€	Largo (cm)	U.Venta
	R61682B	7,50	20	1



**Picadora**  
Hachoir · Fleischwolf  
Mincer · Picadora

	Ref	€	ml	U.Venta
	R61682A	12,90	500	1



**Picadora Mix**  
Hachoir · Fleischwolf  
Mincer · Picadora

	Ref	€	ml	U.Venta
	R61679AA	12,40	800	1



**Batidor Varillas Mix**  
Fouet multibrins · Schneebesen  
Wire whisk · Batedeira varetas

	Ref	€	Largo (cm)	U.Venta
	R61679AB	7,00	23	1





## TitanPro



Household use



Picadora incluida  
Mincer included

### Picadora TitanPro

Hachoir · Fleischwolf  
Mincer · Picadora

Ref	€	ml	U.Venta
R61668C	17,50	500	1



### Batidora varillas TitanPro

Fouet multibrins · Schneebesen  
Wire whisk · Batedeira varetas

Ref	€	Largo (cm)	U.Venta
R61668D	8,70	23,5	1

### Batidora TitanPro

Mixer · Mixer  
Mixer · Batedeira

Ref	€	W	Velocidad	Capacidad vaso	Picadora	Medidas	U.Venta
A 61668	47,70	600	15000 rpm	600 ml	-	8,5x6,3x39,5 cm	1
B 61669	60,80	600	15000 rpm	600 ml	500 ml	8,5x6,3x39,5 cm	1

## Picadora Quick



Professional use



### Picadora Quick

Hachoir professionnel · Professioneller Zerkleinerer  
Professional chopper · Picadora profesional

Ref	€	W	Velocidad	L	Medidas	U.Venta
69490	1007,60	735	1500 rpm	3	28,5x32x43 cm	1

- Picadora profesional que pica y tritura todo tipo de alimentos (verduras, hortalizas, carnes y frutos secos, etc.) de manera rápida y homogénea.
- Contenedor extraíble de acero inoxidable 18/10 de máxima calidad de 3 litros de capacidad.
- Tapa de trítan transparente totalmente extraíble con orificio para añadir ingredientes en marcha. Libre de BPA.
- Cuchillas extraíbles de acero inoxidable totalmente afiladas.
- 100% seguro: evita la puesta en marcha si el contenedor o la tapa no están en la posición adecuada.
- Motor de 735W de potencia y velocidad de 1500 rpm.
- Dispone de protección contra el sobrecalentamiento.
- Encendido y apagado con un solo clic mediante el botón ON / OFF.
- Cubeta inclinada para una fácil introducción y recogida de los alimentos.
- Pies antideslizantes para una máxima estabilidad.
- Fácil limpieza. Contenedor y tapa aptos para el lavavajillas.

- Professional chopper that itch and crush all kinds of food (vegetables, vegetables, meats and nuts, etc.) quickly and homogeneously.
- Removable stainless steel container 18/10 of maximum quality of 3 liters of capacity.
- Transparent Tritan Cover totally removable with hole to add in progress. BPA free.
- Removable stainless steel blades fully sharp.
- 100% Sure: Avoid implementing whether the container or lid are not in the right position.
- 735W engine of power and speed of 1500 rpm.
- It has protection against overheating.
- Light and off with a single click using the ON / OFF button.
- Inclined bucket for easy introduction and collection of food.
- Non -slip feet for maximum stability.
- Easy cleaning. Container and cover suitable for dishwasher.

## Picadora Quartz



Household use



- Picadora eléctrica compacta que pica todo tipo de alimentos, como verduras, frutas, jengibre, ajo, cebolla, frutos secos y hierbas.
- Cabezal de acero inoxidable y recipiente de cristal de alta calidad.
- Cuchillas ultrarresistentes.
- Gracias a los engranajes metálicos permite un uso continuo.
- Corta con precisión y homogéneamente.
- 2 velocidades; la más veloz para un corte rápido y la más lenta para un corte más controlado.
- Base antideslizante para facilitar la tarea y evitar desplazamientos.
- Fácil de desmontar y limpiar. Contenedor y cuchillas aptos para el lavavajillas.

- Compact electric chopper that itch all kinds of food, such as vegetables, fruits, ginger, garlic, onion, nuts and herbs.
- Stainless steel head and high quality glass container.
- Ultra -resistant blades.
- Thanks to metal gears allows continuous use.
- Cut precisely and homogeneously.
- 2 speeds; The fastest for a quick and slower cut for a more controlled cut.
- Non -slip base to facilitate task and avoid displacements.
- Easy to disassemble and clean. Container and blades suitable for dishwasher.

### Picadora Quartz

Hachoir en verre · Fleischwolf, glas  
Glass mincer · Picadora de vidro

Ref	€	W	L	Cuchillas	Medidas	U.Venta
69077	46,60	300	1,2	4	19x16x25 cm	1
69073	71,70	300	2,0	4	21x17,5x27 cm	1



# Picadoras de carne

AL FUNDIDO BPA free AC CE RoHS *Semiprofessional use*

- Picadoras estables y resistentes.
- Engranajes interiores y exteriores metálicos para una mayor resistencia.
- Incluyen 3 discos perforados de acero inoxidable.
- Incluyen 4 accesorios extra (Kibbe incluido).
- Totalmente desmontables para facilitar su limpieza.

- Hachoirs stables et résistants.
- Engrainages intérieurs et extérieurs métalliques pour une plus grande résistance.
- Inclut 3 disques perforés en acier inoxydable.
- Inclut 4 accessoires supplémentaires (kebbeh inclus).
- Totalemt démontable pour faciliter son nettoyage.

- Stable and resistant choppers.
- Interior and exterior metal gear teeth for improved resistance.
- Includes 3 stainless steel perforated discs.
- Includes 4 extra accessories (Kibbe included).
- Can be fully disassembled for easy cleaning



3 discos perforados  
3 stainless steel perforated discs



Embutidos (salchichas, chorizo...)  
Sausages (salchicha, chorizo...)



Kibbe  
kibbe



Productividad  
2 kg/min  
Productivity



## Picadora de carne Pro

Hachoir pour viande · Fleischwolf  
Meat mincer · Picadora de carne

Ref	€	W	Par motor	Velocidad	Capacidad	Medidas	U.Venta
69368	612,60	550	1,27 Nm	240 rpm	2kg/min	53,5x26x35 cm	1



Productividad  
1 kg/min  
Productivity



Productividad  
1 kg/min  
Productivity

## Picadora de carne Strong

Hachoir pour viande · Fleischwolf  
Meat mincer · Picadora de carne

Ref	€	W	Par motor	Capacidad	Medidas	U. Venta
69068	240,40	800	0,25 Nm	1 Kg/min	35x18x36 cm	1

## Picadora de carne Chop

Hachoir pour viande · Fleischwolf  
Meat mincer · Picadora de carne

Ref	€	W	Par motor	Capacidad	Medidas	U. Venta
69369	120,50	300	0,14 Nm	1 Kg/min	43x17x36 cm	1

# Cortadoras Fiambre

BPA free CE RoHS

- Cortadora eléctrica de alto rendimiento.
- Corta sin esfuerzo y con una gran precisión.
- Cuchilla desmontable de acero inoxidable de gran calidad.
- Regulador de grosor de corte entre 0 y 11/13 mm.
- Estructura de aluminio, transmisión por correa, pantalla protectora y cabezal ajustable de suave deslizamiento.
- Cuenta con un alador extraíble para ayudar al mantenimiento de la cuchilla.

- Cutter électrique haute performance.
- Coupez sans effort et avec une grande précision.
- Lame amovible en acier inoxydable détachable.
- Coupez un régulateur épais entre 0 et 11/13 mm.
- Structure en aluminium, transmission de la courroie, écran de protection et tête réglable de glissement doux.
- Il a un aor amovible pour aider à la maintenance de la lame.

- High performance electric cutter.
- Cut effortlessly and with great precision.
- Detachable stainless steel removable blade.
- Cut thick regulator between 0 and 11/13 mm.
- Aluminum structure, belt transmission, protective screen and adjustable head of soft slip.
- It has a removable aor to help maintenance of the blade.

Professional use



AL Aluminium DC M

Cortadora de fiambre Profesional  
Trancheuse de charcuterie · Aufschnittmaschine  
Cold meat cutter · Cortadora de fiambre

Ref	€	W	Cuchilla (cm)	Espesor corte	Medidas	U.Venta
69125	678,30	150	Ø 25	0-11 mm	49x39x36 cm	1
69130	1158,80	250	Ø 30	0 - 13 mm	60x58x44 cm	1

Household use



INOX 18/10 AC M

Cortadora de fiambre Home  
Trancheuse de charcuterie · Aufschnittmaschine  
Cold meat cutter · Cortadora de fiambre

Ref	€	W	Cuchilla (cm)	Espesor corte	Medidas	U.Venta
69118	121,30	150	Ø 19	0 - 15 mm	37,5x28x27,5 cm	1

# Cortador de Kebab

INOX DC Dishwasher CE RoHS Household use

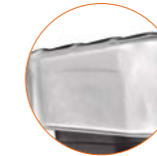

- Potente, silencioso e higiénico.
- Cuchilla desmontable de acero inoxidable de gran calidad.
- Corta sin esfuerzo y con gran precisión.
- Regulador del grosor de corte (Ajustable de 0 a 8 mm).
- Mango ergonómico, se adapta perfectamente a la mano.
- Incluye un destornillador para desmontar la cuchilla y una práctica piedra afiladora.

- Puissant, silencieux et hygiénique.
- Lame amovible en acier inoxydable détachable.
- Coupez sans effort et avec une grande précision.
- Régulateur d'épaisseur de coupe (réglable de 0 à 8 mm).
- Mango ergonomique, s'adapte parfaitement à la main.
- Comprend un tournevis pour démonter la lame et un affûteur de pratique.

- Powerful, silent and hygienic.
- Detachable stainless steel removable blade.
- Cut effortlessly and with great precision.
- Cutting thickness regulator (adjustable from 0 to 8 mm).
- Ergonomic mango, adapts perfectly to hand.
- Includes a screwdriver to disassemble the blade and a practice sharpener.

## Cortador de Kebab

Couteau à kebab · Kebab-Schneider  
Kebab cutter · Cortador de kebab

Ref	€	W	Velocidad	Cuchilla (cm)	Espesor corte	Medidas	U. Venta
69230	200,10	80	2800 rpm	Ø 10	0 - 8 mm	20x11,5x18,5 cm	1

# Cortador de vegetales Profesional

AL INOX    Professional use



- Cortador de verduras para uso profesional.
  - Construida totalmente en aluminio anodizado de alta resistencia.
  - Cuerpo superior abatible para facilitar la limpieza, el mantenimiento y la colocación de los discos de corte.
  - 2 entradas para los diferentes tipos de verduras; entrada semicircular con palanca para alimentos voluminosos (patatas, tomates, cebollas, etc.) y entrada redonda con empujador para verduras y hortalizas más pequeñas (pepinos, calabacín, zanahorias, etc.).
  - Incluye 5 cuchillas: dos discos de corte (2 y 4 mm) y tres discos para rallar (3, 5 y 7 mm).
  - Funcionamiento continuo. Transmisión por correa.
  - 2 sistemas de seguridad: tornillo de bloqueo de tapa y un sensor electromagnético (al abrir la tapa se apaga la máquina).
  - 4 patas de goma para una mejor estabilidad.
- Vegetable cutter for professional use.
  - Built completely in high -strength anodized aluminum.
  - Folding upper body to facilitate cleaning, maintenance and placement of cutting discs.
  - 2 entries for different types of vegetables; Semicircular input with bulky food lever (potatoes, tomatoes, onions, etc.) and round entrance with smaller vegetables and vegetables (cucumbers, zucchini, carrots, etc.).
  - Includes 5 blades: two cutting discs (2 and 4 mm) and three albums to grate (3, 5 and 7 mm).
  - Continuous operation. Correa transmission.
  - 2 safety systems: cover lock screw and an electromagnetic sensor (when opening the lid the machine is turned off).
  - 4 rubber legs for better stability.

## Cortador de vegetales Profesional

Disque de coupe · Schneidscheibe  
Cutter disc · Disco de corte

Ref	€	W	Velocidad	Medidas	U.Venta
69500	1424,20	550	270 r.p.m,	57x23x51 cm	1



# Accesorios



## Disco rallador

Disque de coupe · Schneidscheibe  
Cutter disc · Disco de corte

Ref	€	mm	U.Venta
<b>A</b> 69503	47,50	3	1
<b>B</b> 69505	47,50	5	1
<b>C</b> 69507	47,50	7	1

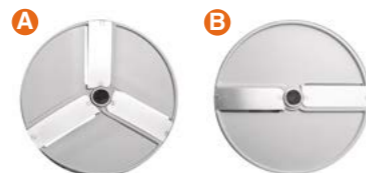

## Disco cortador

Disque de coupe · Schneidscheibe  
Cutter disc · Disco de corte

Ref	€	mm	U.Venta
<b>A</b> 69512	47,50	2	1
<b>B</b> 69514	47,50	4	1

## Disco cortador (no incluido)

Disque de coupe · Schneidscheibe  
Cutter disc · Disco de corte

Ref	€	mm	U.Venta
<b>A</b> 69518	94,70	8	1
<b>B</b> 69510	94,70	10	1
<b>C</b> 69504	110,00	10	1
<b>D</b> 69506	128,70	10x10	1



# Procesador de alimentos MultiGenius

INOX 18/10     Household use



- Múltiples funciones: pica, ralla, mezcla, bate, monta y tritura.
- Rendimiento óptimo y profesional: resultados rápidos, homogéneos e inmejorables.
- Gran capacidad; recipiente transparente graduado y jarra batidora transparente graduada.
- Infinidad de posibilidades: gracias a sus accesorios de alto rendimiento podrás cocinar sin esfuerzo.
- Tapa y bol con sistema de anclaje de seguridad.
- Diseño atractivo, compacto y muy cómodo para guardar: los accesorios pueden guardarse en el mismo recipiente.

- Multiple functions: Pica, Ralla, Mix, bat, riding and crushing.
- Optimal and professional performance: rapid, homogeneous and unbeatable results.
- Great capacity; Transparent graduate container and graduated transparent blender jug.
- Ifinity of possibilities: Thanks to its high performance accessories you can cook effortlessly.
- Cover and bowl with safety anchor system.
- Attractive, compact and very comfortable design to save: accessories can be stored in the same container.



- Corte con cuchilla**  
Cutting with blades
- Exprimidor**  
Citrus press
- Conjunto Cuchillas**  
**Mezclador-amasa-**  
**dor Batidor**  
Set Blades  
Mixer-kneader · Whisk
- Jarra batidora**  
Blender jug

## Procesador de alimentos MultiGenius

Robot multifonction · Küchenmaschine  
Food processor · Processador de alimentos

Ref	€	W	Velocidad	Capacidad vaso	U.Venta
69579	135,60	800	2+PULSE	2L (jarra), 1,5L (jarra batido)	1

# Robot multifunción

INOX 18/10     Household use



- Jarra batidora**  
Blender jug
- Conjunto batidor/montador**  
Blending/whipping unit
- Molinillo + Tapa**  
Grinder + Lid
- Discos corte**  
Cutting discs



- Conj. exprimidor**  
Juicer attachment
- Cortador mini**  
Mini cutter
- Conj. licuadora**  
Smoothie unit
- Corte con cuchilla**  
Cutting with blades

## Robot multifunción

Robot multifonctions · Multifunktions-Roboter  
Multifunction robot · Robò multifuncionalis

Ref	€	W	Velocidad	Capacidad vaso	U.Venta
69079	189,30	800	10	1,5 L	1

# Corta vegetales + Máquina de helado Cosmo

INOX 18/10 BPA free AC CE Household use



- Versátil: procesador eléctrico de verduras con accesorio para hacer helado.
- Incluye 6 cuchillas de corte (en formato cono) de acero inoxidable de máxima calidad para todo tipo de cortes; verdura, fruta, queso, frutos secos, chocolate, etc.
- Incluye un accesorio diseñado para hacer helados y sorbetes con fruta congelada.
- Rápido, intuitivo y muy fácil de usar.
- Compacto: práctico para usar y guardar; las cuchillas se almacenan en el interior.
- 100% seguro: no hay contacto directo con las manos.
- Funcionamiento silencioso.

- Versatile: Electric vegetable processor with accessory to ice cream.
- Includes 6 cutting blades (in cone format) of maximum stainless steel for all types of cuts; vegetables, fruit, cheese, nuts, chocolate, etc.
- Includes an accessory designed to make ice cream and sorbets with frozen fruit.
- Fast, intuitive and very easy to use.
- Compact: practical to use and save; The blades are stored inside.
- 100% Insurance: There is no direct contact with the hands.
- Silent functioning.

## Corta vegetales + Máquina de helado Cosmo

Hachoir légumes + machine à fruitcreme glacee · Gemüseschneider + Obst-Eis machine  
Vegetables cutter + ice fruit machine · Corta vegetables + máq. de gelado de fruta

Ref	€	W	Cuchillas	Medidas	U.Venta
69115	82,50	150	6	24,5x22,5x19,5 cm	1

# Cocedor de vapor Ecco

PS Plastic BPA free CE Household use



- Vaporera multifunción para cocinar al vapor todo tipo de verduras, pescados, arroces, huevos, etc.
- Gracias a la cocción a baja temperatura, los alimentos mantienen las vitaminas, las sales minerales y la textura de los alimentos.
- 3 recipientes: Diseñado para preparar varios alimentos simultáneamente manteniendo todos los sabores, aromas y nutrientes.
- Contenedor especial para cocinar arroz.
- Capacidad: 12L.
- 100% Libre de BPA.

- Cuit-vapeur multifonction pour cuire à la vapeur toutes sortes de légumes, poissons, riz, œufs, etc.
- Grâce à la cuisson à basse température, les aliments conservent leurs vitamines, leurs sels minéraux et leur texture.
- 3 récipients : Conçus pour préparer plusieurs aliments simultanément en conservant toutes les saveurs, les arômes et les nutriments.
- Récipient spécial pour la cuisson du riz.
- Capacité : 12L.
- 100% sans BPA.

- Multifunction steamer for steaming all kinds of vegetables, fish, rice, eggs, etc.
- Thanks to low-temperature cooking, the food retains its vitamins, mineral salts and texture.
- 3 containers: Designed to prepare several foods simultaneously while maintaining all the flavours, aromas and nutrients.
- Special container for cooking rice.
- Capacity: 12L.
- 100% BPA free.

## Cocedor de vapor Ecco

Cuiseur vapeur · Dampfkochgerät  
Steam cooker · Panela de cocção a vapor

Ref	€	W	Rango temperatura	Capacidad	Medidas	U.Venta
69121	94,50	1000	Hasta 100 °C	12L	41x35x26 cm	1

# Deshidratadores

BPA free CE Household use

- Deshidratador de alimentos profesional fabricado en acero inoxidable de.
- Doble pared lateral que retiene el calor y garantiza su rendimiento térmico.
- Motor-ventilador y sistema de circulación de aire caliente de 360°.
- Puerta de vidrio transparente para controlar el proceso de deshidratación.
- Gran capacidad: Incluye 14 bandejas extraíbles fabricadas en acero inoxidable 18/10.
- Temporizador programable hasta 24h y temperatura ajustable entre 35°-75°.

- Professional food dehydrator made of high quality stainless steel.
- Double side walls retain heat and guarantee thermal performance.
- Fan-motor and 360° hot air circulation system.
- Transparent glass door for monitoring the dehydration process.
- Large capacity: Includes 14 removable trays made of 18/10 stainless steel.
- Programmable timer up to 24h and adjustable temperature between 35°-75°.

INOX 18/10

## Deshidratador de alimentos Dry

Deshydrateur des aliments · Obsttrockner, elektrisch  
Food dehydrator · Desidratador de alimentos

Ref	€	W	Rango temperatura	Capacidad	Medidas	U.Venta
69524	567,90	1000	35-75°C	14 bandejas/ trays	47x44x59 cm	1



Household use



PS Plastic

## Deshidratador giratorio Terra

Déshydrateur tournant · Drehdehydrator  
Rotating dehydrator · Desidratador giratório

Ref	€	W	Rango temperatura	Capacidad	Medidas	U.Venta
69223	133,00	500	70°C (max)	5 bandejas/ trays	Ø33x22 cm	1

Professional use



PS Plastic

## Deshidratador de alimentos Pro

Deshydrateur des aliments · Obsttrockner, elektrisch  
Food dehydrator · Desidratador de alimentos

Ref	€	W	Rango temperatura	Capacidad	Medidas	U.Venta
69523	209,50	800	29°C - 73°C	6 Bandejas/	47x36x26 cm	1

Household use



PS Plastic

## Deshidratador de alimentos White

Déshydrateur des aliments · Obsttrockner, elektrisch  
Food dehydrator · Desidratador de alimentos

Ref	€	W	Rango temperatura	Capacidad	Medidas	U.Venta
69123	78,40	250	70°C (max)	5 bandejas /trays	Ø33 x 27 cm	1

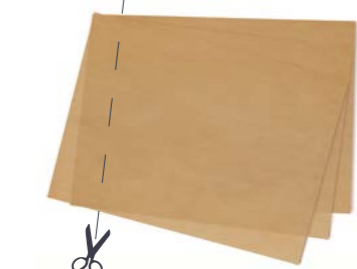

Fácil de cortar  
Easy to cut

Fibra de vidrio 250°C Max  
Fiberglass Oven Microwave Dishwasher  
ECO 770A Max

## Láminas antiadherentes

Feuilles antiadhésif · Antihaf-Blätter  
Non-stick sheets · Láminas antiaderentes

Ref	€	cm	Unidad	U.Venta
66746	10,10	30x40	3	1

# Freidora de inducción

INOX   Professional use

- Ideal para un uso intensivo en la hostelería y cocinas con grandes cargas de trabajo.
- Potente y eficiente. Capacidad de 8 L.
- Construida totalmente en acero inoxidable (exterior e interior) que garantiza durabilidad y resistencia.
- Gracias al sistema de calentamiento por inducción se consigue una temperatura estable en todo el área, disminuyendo el impacto térmico en el momento de introducir los alimentos.
- Control de temperatura variable de 60°C a 190°C.
- Protección contra el sobrecalentamiento.
- Equipada con grifo de vaciado y elemento de calentamiento oculto para facilitar la limpieza.
- Tapa y cesta incluidas

- Idéal pour une utilisation intensive dans l'hospitalité et les cuisines avec de grandes charges de travail.
- Puissant et efficace. 8 L's Capacité.
- Construit totalement en acier inoxydable (extérieur et intérieur) qui garantit la durabilité et la résistance.
- Grâce au système de chauffage à induction, une température stable est obtenue dans toute la zone, ce qui réduit l'impact thermique au moment de l'introduction d'aliments.
- Contrôle de la température variable de 60 ° C à 190 ° C.
- Protection contre la surchauffe.
- Équipé d'un robinet de vidange et d'un élément de chauffage caché pour faciliter le nettoyage.
- Couverture et panier inclus.

- Ideal for intensive use in hospitality and kitchens with large workloads.
- Powerful and efficient. 8 L's capacity.
- Built totally in stainless steel (exterior and interior) that guarantees durability and resistance.
- Thanks to the induction heating system, a stable temperature is achieved throughout the area, reducing the thermal impact at the time of introducing food.
- Variable temperature control from 60°C to 190°C.
- Protection against overheating.
- Equipped with emptying tap and hidden heating element to facilitate cleaning.
- Cover and basket included.



Rejilla  
Basket



Grifo  
Tap



## Freidora de inducción

Friteuse à induction · Induktionsfriteuse  
Induction fryer · Fritadeira de indução

Ref	€	W	L	Temperatura	Medidas	U.Venta
69465	552,10	3500	8	60 - 190°C	29x57x41,5 cm	1

# Freidora Pro

INOX   Professional use

- Destinada a un uso intensivo en restaurantes, bares, hoteles, etc.
- Especial para todo tipo de frituras. Permite freír gran cantidad de alimento.
- Fabricada en acero inoxidable, exterior e interior, garantiza una gran durabilidad y resistencia.
- Termostato de temperatura regulable.
- Termostato de seguridad con rearme manual.
- Mango termorresistente.
- Sistema de fijación de la cesta para escurrir el aceite.
- Indicador máximo-mínimo de nivel de aceite.
- Panel extraíble para facilitar el mantenimiento y la limpieza.

- Destiné à un usage intensif dans les restaurants, les bars, les hôtels, etc.
- Spécial pour tous les types de frites. Il permet de faire frire une grande quantité de nourriture.
- Fabriqué en acier inoxydable, extérieur et intérieur, il garantit une grande durabilité et une résistance.
- Thermostat à température réglable.
- Thermostat de sécurité avec arrière manuel.
- Mangué résistante au thermor.
- Système de fixation du panier pour vider l'huile.
- Mimmus maximum du niveau d'huile.
- Panneau amovible pour faciliter l'entretien et le nettoyage.

- Destined for intensive use in restaurants, bars, hotels, etc.
- Special for all types of friedness. It allows to fry a large amount of food.
- Made of stainless, exterior and interior steel, it guarantees great durability and resistance.
- Adjustable temperature thermostat.
- Safety thermostat with manual rear.
- Thermor resistant mango.
- Basket fixing system to drain the oil.
- Maximum-mimmus of oil level.
- Removable panel to facilitate maintenance and cleaning.



Resistencia  
Resistance



Grifo  
Tap



## Freidora Pro

Friteuse · Friteuse  
Fryer · Fritadeira

Ref	€	W	L	Temperatura	Medidas	U.Venta
A 69169	279,80	2500	6,0	50 - 190°C	27x41x31 cm	1 Simple
B 69466	437,90	2500x2	6,0x2	50 - 190°C	58 x 41,5 x 31 cm	1 Double · Double



## Freidora Pro con grifo

Friteuse avec robinet · Friteuse mit Wasserhahn  
Fryer with tap · Fritadeira com torneira

Ref	€	W	L	Temperatura	Medidas	U.Venta
A 69468	296,80	3250	8,0	50-190°C	27x41x42 cm	1 Simple
B 69469	565,80	3250x2	8,0x2	50-190°C	51 x 48 x 43 cm	1 Double · Double

# Freidora Ergo

INOX   Professional use

- Ideal para un uso intensivo en la hostelería y cocinas con grandes cargas de trabajo.
- Potente y eficiente. Capacidad de 8 L.
- Construida totalmente en acero inoxidable (exterior e interior) que garantiza durabilidad y resistencia.
- Gracias al sistema de calentamiento por inducción se consigue una temperatura estable en todo el área, disminuyendo el impacto térmico en el momento de introducir los alimentos.
- Control de temperatura variable de 60°C a 190°C.
- Protección contra el sobrecalentamiento.
- Equipada con grifo de vaciado y elemento de calentamiento oculto para facilitar la limpieza.
- Tapa y cesta incluidas.

- Idéal pour une utilisation intensive dans l'hospitalité et les cuisines avec de grandes charges de travail.
- Puissant et efficace. 8 L's Capacité.
- Construit totalement en acier inoxydable (extérieur et intérieur) qui garantit la durabilité et la résistance.
- Grâce au système de chauffage à induction, une température stable est obtenue dans toute la zone, ce qui réduit l'impact thermique au moment de l'introduction d'aliments.
- Contrôle de la température variable de 60 ° C à 190 ° C.
- Protection contre la surchauffe.
- Équipé d'un robinet de vidange et d'un élément de chauffage caché pour faciliter le nettoyage.
- Couverture et panier inclus.

- Ideal for intensive use in hospitality and kitchens with large workloads.
- Powerful and efficient. 8 L's capacity.
- Built totally in stainless steel (exterior and interior) that guarantees durability and resistance.
- Thanks to the induction heating system, a stable temperature is achieved throughout the area, reducing the thermal impact at the time of introducing food.
- Variable temperature control from 60°C to 190°C.
- Protection against overheating.
- Equipped with emptying tap and hidden heating element to facilitate cleaning.
- Cover and basket included.



## Freidora Ergo con grifo

Friteuse avec robinet · Friteuse mit Ablaufhahn  
Fryer with tap · Fritadeira com torneira

Ref	€	W	L	Temperatura	U.Venta
69134	201,30	2500	4,0	190° max	1



## Freidora Ergo

Friteuse · Friteuse  
Fryer · Fritadeira

Ref	€	W	L	Temperatura	U.Venta
A 69135	116,30	2000	3,5	190° max	1
B 69170	233,00	4000	3,5 x 2	190° max	1

Simple · Simple  
Doble · Double

# Freidora eléctrica Vue

INOX   Household use

new

- Freidora eléctrica con diseño compacto fabricada en acero inoxidable.
- Cubeta interior de 2,50 L con marcas de capacidad y recubrimiento antiadherente 100% libre de PFOA.
- Temperatura regulable hasta 190°C.
- Temporizador: Preestablece el tiempo de fritura deseado hasta 30min.
- Máximo control: Tapa con ventana para controlar la fritura y evitar salpicaduras. Dispone de un filtro anti-olores que evita el olor a aceite una vez cocinado.
- Cestillo con mango abatible con apertura y cierre bloqueo y sistema de fijación de la cesta para escurrir el aceite.

- Friteuse électrique compacte en acier inoxydable.
- Chauffage rapide et efficace : résultats parfaits en très peu de temps grâce à sa puissance de 1600W.
- Cuve intérieure de 2,50 litres avec marquage de capacité et revêtement antiadhésif 100 % sans PFOA.
- Température réglable jusqu'à 190°C.
- Minuterie : pré-réglage de la durée de friture souhaitée jusqu'à 30 minutes.
- Contrôle maximal : Couvercle avec fenêtre pour contrôler la friture et éviter les éclaboussures. Il dispose d'un filtre anti-odeur qui empêche l'odeur de l'huile une fois la cuisson terminée.
- Panier avec poignée rabattable avec verrouillage de l'ouverture et de la fermeture et système de fixation du panier pour vidanger l'huile.

- Electric fryer with compact design made of stainless steel.
- Fast and efficient heating: Perfect results in a very short time thanks to its 1600W power.
- 2.50 L inner pan with capacity markings and 100% PFOA-free non-stick coating.
- Adjustable temperature up to 190°C.
- Timer: Pre-sets the desired frying time up to 30min.
- Maximum control: Lid with window to control frying and avoid splashing. It has an anti-odour filter that prevents the smell of oil once cooked.
- Basket with folding handle with opening and closing lock and basket fixing system to drain the oil



## Freidora eléctrica Vue

Friteuse électrique · Elektrische Friteuse  
Electric fryer · Fritadeira eléctrica

Ref	€	W	L	Temperatura	U.Venta
69448	82,40	1600	2,5	190° max	1

# Freidora eléctrica Intact

INOX   Household use

new

- Ideal para un uso intensivo en la hostelería y cocinas con grandes cargas de trabajo.
- Potente y eficiente. Capacidad de 8 L.
- Construida totalmente en acero inoxidable (exterior e interior) que garantiza durabilidad y resistencia.
- Gracias al sistema de calentamiento por inducción se consigue una temperatura estable en todo el área, disminuyendo el impacto térmico en el momento de introducir los alimentos.
- Control de temperatura variable de 60°C a 190°C.
- Protección contra el sobrecalentamiento.
- Equipada con grifo de vaciado y elemento de calentamiento oculto para facilitar la limpieza.
- Tapa y cesta incluidas.

- Idéal pour une utilisation intensive dans l'hospitalité et les cuisines avec de grandes charges de travail.
- Puissant et efficace. 8 L's Capacité.
- Construit totalement en acier inoxydable (extérieur et intérieur) qui garantit la durabilité et la résistance.
- Grâce au système de chauffage à induction, une température stable est obtenue dans toute la zone, ce qui réduit l'impact thermique au moment de l'introduction d'aliments.
- Contrôle de la température variable de 60 ° C à 190 ° C.
- Protection contre la surchauffe.
- Équipé d'un robinet de vidange et d'un élément de chauffage caché pour faciliter le nettoyage.
- Couverture et panier inclus.

- Ideal for intensive use in hospitality and kitchens with large workloads.
- Powerful and efficient. 8 L's capacity.
- Built totally in stainless steel (exterior and interior) that guarantees durability and resistance.
- Thanks to the induction heating system, a stable temperature is achieved throughout the area, reducing the thermal impact at the time of introducing food.
- Variable temperature control from 60°C to 190°C.
- Protection against overheating.
- Equipped with emptying tap and hidden heating element to facilitate cleaning.
- Cover and basket included.



## Freidora eléctrica Intact

Friteuse électrique · Elektrische Friteuse  
Electric fryer · Fritadeira eléctrica

Ref	€	W	L	Temperatura	U.Venta
69447	89,90	3270	4,2	190° max	1



## Freidora de aire dAirePro



- **RapidAir Technology:** La tecnología de ventilación de aire caliente circula a máxima velocidad y a 360° dentro de la cámara de cocción, garantizando así una distribución uniforme del calor en el interior y una cocción homogénea de todos los alimentos.
- **Máxima versatilidad "9 en 1":** Con los 9 programas automáticos preestablecidos podrás cocinar todo tipo de recetas de forma rápida y sana: patatas fritas, pollo, costilla, verduras, pescado, pizza, incluso deshidratar alimentos.
- **Pantalla Led táctil:** Intuitiva y muy fácil de usar. Control de tiempo (hasta 60 minutos y 6 horas para deshidratar) y ajuste de temperatura de cocción de forma precisa (de 40°C a 200°C).
- **7 accesorios incluidos:** 3 rejillas, bandeja, cestillo redondo, pincho mariposa y asa para cestillo redondo.

- Cuisine maison et saine : Conçue pour frire, déshydrater, cuire, rôtir et maintenir au chaud.
- RapidAir Technology : La technologie de ventilation à air chaud circule à une vitesse maximum et à 360° dans la chambre de cuisson, garantissant ainsi une distribution uniforme de la chaleur à l'intérieur et une cuisson homogène de tous les aliments.
- Versatilité maximum « 9 en 1 » : Avec les 9 programmes automatiques préétablis, vous pourrez cuisiner tout type de recettes de façon saine et rapide : frites, poulet, côtes de viande, légumes, poisson, pizza, et même déshydrater des aliments.
- Écran Led tactile : Intuitif et très facile à utiliser. Contrôle de temps (jusqu'à 60 minutes et 6 heures pour déshydrater) et réglage de la température de cuisson de façon précise (de 40°C à 200°C).
- 7 accessoires inclus : 3 grilles, plateau, panier rond, tournebroche et poignée pour panier rond.

- Healthy, homemade cooking: designed to fry, dehydrate, bake, roast and keep food warm.
- RapidAir Technology: the air ventilation technology circulates hot 360°C air at maximum speed inside the cooking chamber, which distributes the heat uniformly inside the oven and guarantees that all food is cooked evenly.
- Maximum "9-in-1" versatility: 9 pre-set automatic programmes for you to cook all kinds of recipes quickly and healthily: chips, chicken, ribs, vegetables, fish, pizza and even dehydrate food.
- LED touch screen: very practical and easy to use. Time control (up to 60 minutes and 6 hours for dehydration) and precise cooking temperature settings (from 40°C to 200°C).
- 7 accessories included: 3 racks, tray, round basket, skewer with clamps and handle for round basket.



**Freidora de aire dAirePro**  
Friteuse airfryer · Aidfryer Heißluft-Fritteuse  
Air fryer · Friteira de aire

Ref	€	W	L	Rango temperatura	Tiempo	Medidas	U.Venta
69513	192,60	1700W	12 L	40°C-200°C	1-6h	32,5x36x37,5 cm	1



## Freidora de aire DuploAir



- **11 programas automáticos preestablecidos:** diseñado para freír, hornear, asar, calentar, descongelar y deshidratar.
- **Gran capacidad: 9 L (dos cestillos extraíbles de 4,5 L de capacidad cada uno).**
- **Cestillo doble: control de tiempo y temperatura independiente. Cocina dos platos distintos al mismo tiempo, manteniendo el aroma y el sabor de cada plato.**
- **SyncFinish: acabado sincronizado. Cocina en ambos cestillos con tiempo y temperatura diferente acabado al mismo tiempo.**
- **Tecnología TotalCook: distribuye el calor de manera uniforme a través del aire caliente.**
- **100% ECO y libre de PFAS.**

- 11 Programmes automatiques fournis: Conçu pour faire frire, cuire, rôtir, chauffer, dégivrer et déshydrater.
- Grande capacité: 9 L (deux paniers amovibles de 4,5 L de capacité chacun).
- Double panier: contrôle du temps et température indépendante. Cuire deux plats différents en même temps, en gardant l'arôme et le goût de chaque plat.
- Syncfinish: finition synchronisée. Cuisine dans les deux paniers avec un temps et une température différents en même temps.
- Totalcook Technology: distribue la chaleur uniformément dans l'air chaud.
- 100% ECO et exempt de PFAS.

- 11 Automatic programs provided: designed to fry, bake, roast, heat, defrost and dehydrate.
- Great capacity: 9 L (two removable baskets of 4.5 L of capacity each).
- Double basket: time control and independent temperature. Cook two different dishes at the same time, keeping the aroma and taste of each dish.
- Syncfinish: synchronized finish. Kitchen in both baskets with different time and temperature finish at the same time.
- TotalCook technology: distributes heat evenly through hot air.
- 100% ECO and free of PFAS.



**Tecnología TotalCook**  
TotalCook Technology

**Incluye rejilla**  
Grid included

**Freidora de aire DuploAir**  
Friteuse airfryer · Aidfryer Heißluft-Fritteuse  
Air fryer · Friteira de aire

Ref	€	W	L	Rango temperatura	Tiempo	Medidas	U.Venta
69508	218,40	2400	4 L (x2)	45°C - 200°C	1-60 min	41x33,5x31,5 cm	1





## Freidora de aire CrystalFry



Household use

- **8 programas automáticos preestablecidos para cocinar todo tipo de recetas de forma rápida y sana: patatas fritas, alitas de pollo, pizza etc. garantizando resultados sorprendentes.**
- **Todas las funciones disponen de un tiempo de precalentamiento para conseguir resultados óptimos**
- **Tecnología TotalCook: distribuye el calor de manera uniforme a través del aire caliente a gran velocidad.**
- **Gran capacidad: 7,0 litros.**
- **Intuitiva y muy fácil de usar: gracias a la pantalla digital se puede ajustar el tiempo (hasta 60 minutos), la temperatura (de 40°C a 200°C.) y los 8 programas preestablecidos.**
- **Cestillo extraíble con antiadherente 100% libre de PFAS. Libre de BPA.**

- 8 programmes automatiques pré-réglés pour cuire rapidement et sainement toutes sortes de recettes: frites, ailes de poulet, pizza, etc. garantissant des résultats étonnants.
- Toutes les fonctions ont un temps de préchauffage afin d'obtenir des résultats optimaux.
- Technologie TotalCook : distribue la chaleur de manière homogène à travers l'air chaud à grande vitesse.
- Grande capacité : 7,0 litres.
- Intuitif et très facile à utiliser : grâce à l'affichage numérique, vous pouvez régler le temps (jusqu'à 60 minutes), la température (de 40°C à 200°C) et les 8 programmes prédéfinis.
- Panier amovible avec revêtement antiadhésif sans PFAS. Sans BPA.

- It has 8 pre-set automatic programmes for making all kinds of recipes in a fast and healthy way: chips, chicken wings, pizza, etc. with excellent results guaranteed.
- All the functions have a preheating time to get optimal results.
- TotalCook Technology: It distributes heat uniformly with high speed hot air.
- High capacity: 7,0 litres.
- Intuitive and very easy to use: Thanks to the digital screen, you can set the time (up to 60 minutes), temperature (from 40°C to 200°C) and use 8 pre-set programmes.
- TotalControl: controls the cooking process thanks to glass door and interior light.
- The removable non-stick basket is 100% PFAS free. BPA free.



**Tecnología TotalCook**  
TotalCook Technology



**Incluye rejilla**  
Grid included



**TotalControl: controla el cocinado gracias a la puerta de cristal y la luz interior**

TotalControl: control the cooking process thanks to glass door and interior light

**Freidora de aire CrystalFry**  
Friteuse airfryer · Aidfryer Heißluft-Fritteuse  
Air fryer · Friteira de aire

Ref	€	W	L	Rango temperatura	Tiempo	Medidas	U.Venta
69515	130,40	1700	7,0	40°-200°C	0-60 min	41x30x34,5 cm	1



## Freidora de aire EcoFry



Household use

- **8 programas automáticos preestablecidos para cocinar todo tipo de recetas de forma rápida y sana: patatas fritas, alitas de pollo, pizza etc.**
- **Todas las funciones disponen de un tiempo de precalentamiento para conseguir resultados óptimos**
- **Tecnología TotalCook: distribuye el calor de manera uniforme a través del aire caliente a gran velocidad.**
- **Gran capacidad: 5,5 litros (cestillo).**
- **Intuitiva y muy fácil de usar: gracias a la pantalla digital se puede ajustar el tiempo (hasta 60 minutos), la temperatura (de 40°C a 200°C) y los 8 programas preestablecidos.**
- **Cestillo extraíble con antiadherente 100% libre de PFAS.**

- 8 Programmes automatiques pré-établis pour cuisiner toutes sortes de recettes rapidement et saines: pommes de terre frites, ailes de poulet, pizza, etc.
- Toutes les fonctions ont un temps de préchauffage pour obtenir des résultats optimaux
- TotalCook Technology: distribue la chaleur uniformément dans l'air chaud à grande vitesse.
- Grande capacité: 5,5 litres (panier).
- Intuitif et très facile à utiliser: grâce à l'écran numérique, vous pouvez ajuster le temps (jusqu'à 60 minutes), la température (de 40 ° C à 200 ° C) et les 8 programmes pré-établi.
- Panier amovible avec 100% sans PFAS.

- 8 Pre-established automatic programs for cooking all kinds of recipes quickly and healthy: fried potatoes, chicken wings, pizza etc.
- All functions have a preheating time to achieve optimal results
- TotalCook technology: distributes heat evenly through hot air at high speed.
- Great capacity: 5.5 liters (basket).
- Intuitive and very easy to use: Thanks to the digital screen you can adjust the time (up to 60 minutes), the temperature (from 40°C to 200°C) and the 8 pre-established programs.
- Removable basket with 100% free of PFAS.
- Easy cleaning: accessories suitable for dishwasher.



**Incluye rejilla**  
Grid included



**Tecnología TotalCook**  
TotalCook Technology

**Freidora de aire EcoFry**  
Friteuse airfryer · Aidfryer Heißluft-Fritteuse  
Air fryer · Friteira de aire

Ref	€	W	Capacidad cestillo	Rango temperatura	Medidas	U.Venta
69511	175,70	1700	5,5L	40°C - 200°C	41x30x34,5 cm	1







## Freidora de aire VitalCook



Household use

- **Cocina casera y saludable: diseñada para freír, hornear, asar y calentar sin apenas utilizar aceite.**
- **Cocina todo tipo de recetas de forma rápida y sana: patatas fritas, alitas de pollo, etc. garantizando resultados sorprendentes.**
- **Tecnología TotalCook: distribuye el calor de manera uniforme a través del aire caliente a gran velocidad.**
- **Capacidad: 3,0 litros.**
- **Recipiente extraíble con antiadherente 100% libre de PFAS. Libre de BPA.**

- Cuisine maison et saine: conçue pour faire frire, cuire, rôtir et chauffer sans utiliser d'huile.
- Cuisine tous les types de recettes rapidement et en bonne santé: pommes de terre frites, ailes de poulet, etc. garantir des résultats surprenants.
- TotalCook Technology: distribue la chaleur uniformément dans l'air chaud à grande vitesse.
- Capacité: 3,0 litres.
- Conteneur amovible avec 100% sans PFAS.
- Il comprend un livre de recettes exclusif et conçu par Lacor en 3 langues. Sans BPA.

- Homemade and healthy kitchen: designed to fry, bake, roast and heat without using oil.
- Kitchen all types of recipes quickly and healthy: fried potatoes, chicken wings, etc. guaranteeing surprising results.
- TotalCook technology: distributes heat evenly through hot air at high speed.
- Capacity: 3.0 liters.
- Removable container with 100% free of PFAS..
- BPA free.



Incluye rejilla  
Grid included

Tecnología  
TotalCook  
TotalCook  
Technology



**Freidora de aire VitalCook**  
Friteuse airfryer · Aidfryer Heißluft-Fritteuse  
Air fryer · Fritedeira de aire

Ref	€	W	L	Tiempo	Rango temperatura	Medidas	U.Venta
69509	110,50	1000	3 L	1-60 minutos	40°C - 200°C	34x25x33 cm	1

## Hornos sobremesa

CE Semiprofessional use

- **Horno eléctrico de sobremesa de convección con carcasa de acero en acabado negro.**
- **Alto rendimiento en un diseño compacto.**
- **Manejable y funcional.**
- **5 funciones predefinidas y temporizador de 0-120 minutos con señal sonora.**
- **Temperatura ajustable máx. de 230°C.**
- **Transfiere el calor a través de 4 resistencias.**
- **Pared de aislamiento y puerta abatible de doble cristal de alta resistencia.**
- **Luz interior que permite vigilar el proceso.**
- **Revestimiento antiadherente interior para una fácil limpieza. 100% libre de PFOA.**
- **Incluye: bandeja para hornear, parrilla, pinza para bandeja, rustidor giratorio, mango para el rustidor y bandeja recogemigas.**

- Cour de bureau de convection électrique avec boîtier en acier en finition noire.
- Haute performance dans une conception compacte.
- Gérable et fonctionnel.
- 5 fonctions prédéfinies et minuterie de 0 à 120 minutes avec un signal sonore.
- Max. de 230 ° C.
- Il transfère la chaleur à travers 4 résistances.
- Mur d'isolement et porte en verre à double résistance pliante.
- Lumière intérieure qui permet de surveiller le processus.
- Doublure anti-intérieure pour un nettoyage facile. 100% sans PFOA.
- Comprend: plateau à pâtisserie, gril, collier de plateau, rouille rotative, manguue pour le roullain et les récupérations du plateau.

- Electrical convection desk oven with steel housing in black finish.
- High performance in a compact design.
- Manageable and functional.
- 5 predefined functions and timer of 0-120 minutes with a sound signal.
- Max. of 230°C.
- It transfers heat through 4 resistances.
- Isolation wall and folding double-resistance glass door.
- Interior light that allows to monitor the process.
- Interior antiating lining for easy cleaning. 100% free from PFOA.
- Includes: baking tray, grill, tray clamp, rotating rusting, mango for the rustor and tray collects.



### Horno sobremesa

Four à poser · Tischbackofen  
Countertop oven · Forno de mesa

	Ref	€	W	L	Rango temperatura	Tiempo	Medidas internas	U.Venta
A	69327	223,80	1650	28	70°C - 230°C	0-120 min	34,5x28x20 cm	1
B	69347	251,40	1850	35	70°C - 230°C	0-120 min	36,5x28,5x23 cm	1



CRISTAL Glass

### Horno halógeno convección Glass

Four à convection halogène · Obstrockner, Elektrisc  
Convection halogen glass oven · Forno de vidro

	Ref	€	W	L	Rango temperatura	Tiempo	Medidas	U.Venta
	69312	97,40	1400	12 L	125°C - 250°C	0-60 min	41x33x31 cm	1



Mecanismo de ciclo de aire caliente  
Hot air cycle mechanism

- **Funciones: asar, cocer, hervir, freír, gratinar, tostar y descongelar.**
- **Reduce el nivel de grasa de los alimentos.**
- **2 mandos: temporizador y nivel de temperatura.**
- **Capacidad: 12 L con la posibilidad de 5 L adicionales.**

- Fonctions: Rôtir, cuisiner, bouillir, frire, gratin, toast et déglacer.
- Réduit le niveau de graisse alimentaire.
- 2 Commandes: Timer et niveau de température.
- Capacité: 12 L avec la possibilité de 5 supplémentaires.

- Functions: roasting, cooking, boiling, frying, gratin, toast and defrost.
- Reduces food fat level.
- 2 controls: timer and temperature level.
- Capacity: 12 L with the possibility of additional 5.

# Horno pizza Lecco

new

Cordierita INOX CE  Professional use

- Estructura fabricada en acero inoxidable de gran calidad.
- Horno eléctrico con aislamiento térmico.
- Ideal para hornear pizzas, panes, tartas, etc. en cualquier restaurante, cafetería o bar.
- Obtén pizzas con una base crujiente y dorada, gracias a la piedra de cordierita 100% natural de alta resistencia al calor de 40x40 cm
- Equipado con iluminación interior y puerta con doble cristal atermico para controlar el proceso con seguridad.
- La temperatura de la parte superior e inferior se puede ajustar por separado con termostatos independientes.
- Rango de temperatura de 0 a 300°C.

- Structure en acier inoxydable de haute qualité.
- Four électrique avec isolation thermique.
- Idéal pour la cuisson de pizzas, pains, gâteaux, etc. dans tout restaurant, cafétéria ou bar.
- Obtenez des pizzas avec une base croustillante et dorée, grâce à la pierre en cordierite 100 % naturelle à haute résistance thermique de 40x40 cm.
- Équipé d'un éclairage intérieur et d'une porte à double vitrage athermique pour contrôler le processus en toute sécurité.
- La température de la partie supérieure et de la partie inférieure peut être réglée séparément à l'aide de thermostats indépendants.
- Plage de température de 0 à 300°C.

- Structure made of high quality stainless steel.
- Thermally insulated electric oven.
- Ideal for baking pizzas, bread, cakes, etc. in any restaurant, café or bar.
- The 40 x 40 cm 100% natural, highly heat-resistant cordierite stone
- guarantees pizzas with a crispy, golden base.
- Includes interior lighting and a double-glazed athermic door to safely monitor the cooking process.
- Separate thermostats allow upper and lower temperatures to be individually adjusted.
- Temperature range: 0 to 300°C.

A



100% natural high strength cordierite stone  
100% natural high strength cordierite stone

B



## Horno pizza Lecco

Four à pizza · Pizaofen  
Pizza oven · Forno para pizza

Ref	€	W	Temperatura	Medidas	U.Venta
A 69632	333,40	2000	300°C	57x56x28 cm	1
B 69633	475,70	3000	300°C	57x56x44 cm	1

# Microondas

INOX 18/10 CE 



Household use

## Hono microondas Fast

Four micro-ondes avec plateau tournant + Grill · Mikrowelle mit Drehteller + Grill  
Microwave oven with turntable + grill · Microondas com prato giratório + grill

Ref	€	W	L	Medidas internas	Medidas	U.Venta
69330	361,00	900 W	30 L	33x35,5x22,5 cm	52x40x32,5 cm	1



Professional use

## Microondas Tempo

Micro-ondes · Mikrowelle  
Microwave · Microondas

Ref	€	W	L	Medidas internas	Medidas	U.Venta
69329	500,60	1550	25	32x32x19 cm	51x43x31 cm	1



Household use

## Microondas White

Micro-ondes · Mikrowelle  
Microwave · Microondas

Ref	€	W	L	Medidas internas	Medidas	U.Venta
69322	162,20	700	20	31,5x30x20 cm	45x33,5x26 cm	1



Professional use

## Hono microondas Profesional

Four à micro ondes professionnel · Mikrowelle Professional  
Professional microwave oven · Microondas profesional

Ref	€	W	L	Medidas internas	Medidas	U.Venta
69325	645,60	1000	25	32x32x19 cm	51x43x31 cm	1



Household use

## Hono microondas Energy

Four micro-ondes avec plateau tournant + Grill · Mikrowelle mit Drehteller + Grill  
Microwave oven with turntable + grill · Microondas com prato giratório + grill

Ref	€	W	L	Medidas internas	Medidas	U.Venta
69323	275,50	800	23	33x32x20,5 cm	48,5x41x29 cm	1



Household use

## Hono microondas Micro

Four micro-ondes avec plateau tournant + Grill · Mikrowelle mit Drehteller + Grill  
Microwave oven with turntable + grill · Microondas com prato giratório + grill

Ref	€	W	L	Medidas internas	Medidas	U.Venta
69324	299,90	900-1450 W	25 L	35,5x33x21 cm	51x43x30 cm	1

# Placas de inducción

INOX   *Professional use*

- Placas de inducción rápidas, eficaces, seguras, fiables y de gran capacidad de calentamiento.
- Sus diseños portátiles y compactos resultan ideales para su uso en cualquier lugar.
- Botones táctiles, intuitivos y fáciles de utilizar con un toque suave.
- Dispone de función de bloqueo de seguridad para niños.
- 40% ahorro de tiempo y energía respecto a otras placas convencionales.

- Plaque à induction rapide, efficace, sûre, fiable et d'une grande capacité de chauffe.
- Sa conception portable et compacte est idéale pour une utilisation n'importe où.
- Boutons tactiles, intuitifs et faciles à utiliser avec un toucher doux.
- Dispose d'une fonction de blocage de sécurité pour les enfants.
- 40% de gain de temps et d'économies d'énergies par rapport à d'autres plaques conventionnelles

- Fast, efficient, safe, reliable induction hob with high heating capacity.
- Its portable and compact design is ideal for use anywhere.
- Intuitive and easy to use soft touch buttons.
- Includes a child safety lock function.
- 40% saving in time and energy compared to other conventional hobs.

Superficie de calentamiento  
Heating surface



IPX3  
proof



## Placa de inducción Profesional Chef

Plaque induction professionnelle · Profi-Induktionsplatte  
Professional induction cooktop · Placa de indução profissional

Ref	€	W	Niveles potencia	Tiempo	Medidas	U.Venta
69132	443,20	3500	17	180 min	34x43x12 cm	1

Superficie de calentamiento  
Heating surface



## Placa de inducción profesional Easy

Plaque induction professionnelle · Profi-Induktionsplatte  
Professional induction cooktop · Placa de indução profissional

Ref	€	W	Niveles potencia	Medidas	U.Venta
69362	380,20	3500	10	34x44,5x12,5 cm	1

Superficie de calentamiento  
Heating surface



## Placa de inducción profesional Roca

Plaque induction professionnelle · Profi-Induktionsplatte  
Professional induction cooktop · Placa de indução profissional

Ref	€	W	Niveles potencia	Tiempo	Medidas	U.Venta
69337	374,70	2700	10	180 min	30x39x10 cm	1

Superficie de calentamiento  
Heating surface



## Placa de inducción Pro

Table de cuisine à induction · Induktionskochfeld  
Induction cooker · Placa de indução

Ref	€	W	Niveles potencia	Medidas	U.Venta
69371	343,00	3500	10	36x38x12,5 cm	1



Superficie de calentamiento  
Heating surface



## Placa de inducción Slim

Table de cuisine à Induktion · Induktionskochfeld  
Induction cooker · Placa de indução

Ref	€	W	Niveles potencia	Tiempo	Medidas	U.Venta
69332	162,70	2000	8	180 min	30x37x4,5 cm	1

Superficie de calentamiento  
Heating surface



Posibilidad de encastrar  
Encastrable option

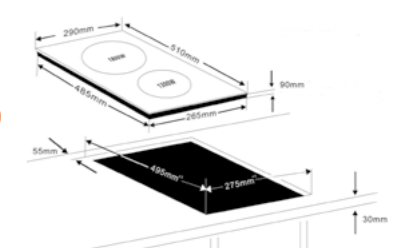

## Placa de inducción Dual Vertical

Plaque induction double · Induktionskochfeld doppelt  
Double induction cooktop · Placa de indução dupla

Ref	€	W	Niveles potencia	Tiempo	Medidas	U.Venta
69033	469,70	1800+1300	8	0-99 min	29x51x9 cm	1

Superficie de calentamiento  
Heating surface



Posibilidad de encastrar  
Encastrable option

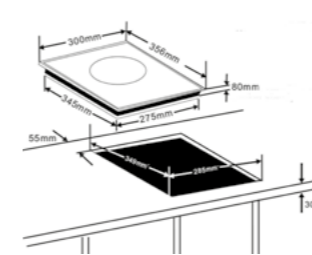

## Placa de inducción Expert

Table de cuisine à induction · Induktionskochfeld  
Induction cooker · Placa de indução

Ref	€	W	Niveles potencia	Tiempo	Medidas	U.Venta
69032	286,90	2000	6	0-180 min	31x36x7,5 cm	1

Superficie de calentamiento  
Heating surface



Posibilidad de encastrar  
Encastrable option

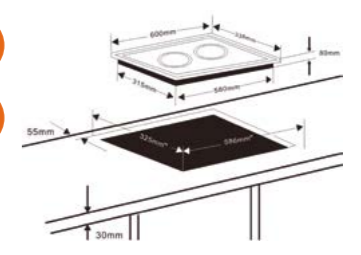

## Placa de inducción Dual Horizontal

Plaque induction · Induktionskochfeld doppelt  
Induction cooktop · Placa de indução

Ref	€	W	Niveles potencia	Tiempo	Medidas	U.Venta
69333	277,60	2000+1500	7	0 - 180 min	60 x 34 x 7,5 cm	1

Placa cerámica: Ø26 cm  
Ceramic plate: Ø26 cm



INOX

### Placa de inducción Wok Profesional

Plaque à induction wok professionnelle · Induktionskochplatte wok professional  
Induction cooktop wok professional · Placa indução wok profissional

### Wok Trimetal

Wok Trimetal · Wok, Trimetal  
Trimetal wok · Wok Trimetal

Ref	€	W	Tiempo	Medidas	U.Venta
69138	460,20	3500 W	180 min	34x44,5x12,5 cm	1

Ref	€	Ø (cm)	h(cm)	e (mm)	L	U.Venta
53836	179,20	36	10,5 cm	2,7 mm	5,50	1

## Placa Vitrocerámica Energy

INOX CE Household use

- Placa vitrocerámica rápida, eficaz, segura, fiable y de gran capacidad de calentamiento.
- Su diseño portátil y compacto resulta ideal para su uso en cualquier lugar.
- Área de cocción de 10 cm / 20 cm de diámetro.
- Botones táctiles, intuitivos y fáciles de utilizar con un toque suave.
- Indicadores luminosos.
- Dispone de función de bloqueo de seguridad para niños.
- Regulable en potencia y temperatura.
- Temporizador de 240 minutos con avisador acústico y auto desconexión.

- Plaque de capacité rapide, efficace, sûre, fiable et de chauffage.
- Sa conception portable et compacte est idéale pour une utilisation n'importe où.
- Zone de cuisson de 10 cm / 20 cm de diamètre.
- Boutons tactiles, intuitifs et faciles à utiliser avec une touche douce.
- Indicateurs lumineux.
- Il a une fonction de verrouillage de sécurité des enfants.
- Réglable en puissance et en température.
- Timer de 240 minutes avec avertissement acoustique et auto-disconnection.

- Fast, effective, safe, reliable and heating capacity plate.
- Its portable and compact design is ideal for use anywhere.
- Cooking area of 10 cm / 20 cm in diameter.
- Tactile buttons, intuitive and easy to use with a soft touch.
- Luminous indicators.
- It has children's security lock function.
- Adjustable in power and temperature.
- 240 minutes timer with acoustic warning and self -disconnection.

Superficie de calentamiento  
Heating surface



### Placa Vitrocerámica Energy

Plaque vitrocéramique · Keramikkochfeld  
Ceramic hob · Placa vitrocerámica

Ref	€	W	Niveles potencia	Tiempo	Superficie placa	Medidas	U.Venta
69232	115,40	2000	8	240 minutos	Ø10-20 cm	39x32x5,5 cm	1

## Planchas grill

INOX CE Professional use



### Salamandra Profesional

Salamandre Professionnelle · Professioneller Grill  
Professional salamander grill · Salamandra Profissional

Ref	€	W	Rango temperatura	Superficie placa	Medidas	U.Venta
69197	1250,80	4000	50°C - 300°C	59 x 32 cm	60x45x50 cm	1

- Estructura de acero inoxidable.
- Ideal para calentar, asar, tostar o gratinar directamente los alimentos.
- Placa de calentamiento y techo móvil, ajusta a la posición deseada.

- Structure en acier inoxydable.
- Idéale pour chauffer, rôti, griller ou gratiner directement les aliments.
- Plaque de chauffe et toit mobile avec réglage de la position souhaitée.

- Stainless steel structure.
- Ideal for directly heating, roasting, toasting or browning food.
- Movable heating plate and roof, adjusting the desired position

A



- Fabricada en acero inoxidable.
- Protector de salpicaduras.
- Placa con superficie lisa de acero laminado y rectificado, calentamiento uniforme.
- Control de temperatura por termostato hasta 300°C.
- Depósito recoge grasas.

- En acier inoxydable.
- Protecteur de éclaboussures.
- Plaque avec surface en acier lancée et rectifiée, chauffage uniforme.
- Contrôle de la température du thermostat jusqu'à 300 ° C.
- Le dépôt collecte les graisses.

- Made of stainless steel.
- Splash protector.
- Plate with smooth rolled and rectified steel surface, uniform heating.
- Thermostat temperature control up to 300°C.
- Deposit collects fats.

B



Cuchillas de acero inoxidable  
Interchangeable  
st. steel  
blades



INOX CE

### Placa grill profesional

Gril Professionnel · Profi-Grill  
Professional grill plate · Grelhador Profissional

Ref	€	W	Área de cocción	Rango temperatura	Medidas	U.Venta
A 69379	396,00	3000	40x40 cm	300°C (max)	40 x 50,3 x 28,5 cm	1 Simple
B 69179	813,50	6000	61x40 cm	300°C (max)	61,5x51x26 cm	1 Doble · Double

AL FUNDIDO  
Aluminium Cast

### Rasqueta profesional para Grill

Racloir professionnel pour grill · Professioneller grillschaber  
Professional grill scraper · Raspador profesional para grill

Ref	€	Cuchilla (cm)	Medidas	U.Venta
67034	72,60	15	42x15x12 cm	1

# Plancha Grill Quality



Household use

- Placa de aluminio fundido antiadherente de gran calidad, libre de PFOA.
- Doble zona de cocción para cocinar todo tipo de alimentos:
  - 1) Grill: ideal para asar carnes, pescados, marisco, hamburguesas o verduras.
  - 2) Lisa: ideal para preparar tortitas, huevos, tostadas o verduras.
- Alcanzan rápidamente la temperatura indicada.
- Garantizan una cocción uniforme por toda la superficie.
- Regulador de temperatura desmontable.
- La ranura central hace que la grasa se deposite en la bandeja recoge-grasas.
- Las asas con recubrimiento aislante de calor proporcionan seguridad.

- Plaque en aluminium fondu de grande qualité, exempte de PFOA.
- Aire à double cuisson pour cuisiner toutes sortes de nourriture:
  - 1) Grill: idéal pour rôtir les viandes, le poisson, les fruits de mer, les hamburgers ou les légumes.
  - 2) Lisa: idéal pour préparer des crêpes, des œufs, du pain grillé ou des légumes.
- Ils atteignent rapidement la température indiquée.
- Ils garantissent une cuisson uniforme sur toute la surface.
- Régulateur de température amovible.
- La fente centrale fait déposer la graisse dans le plateau rassemblé.
- Les poignées thermiques à isolation offrent la sécurité.

- Molten aluminum plaque of great quality, free of PFOA.
- Double cooking area for cooking all kinds of food:
  - 1) Grill: Ideal for roasting meats, fish, seafood, hamburgers or vegetables.
  - 2) Lisa: Ideal for preparing pancakes, eggs, toast or vegetables.
- They quickly reach the indicated temperature.
- They guarantee a uniform cooking throughout the surface.
- Removable temperature regulator.
- The central slot causes the fat to be deposited in the gathered tray.
- Heat insulating coat handles provide safety.



## Plancha Grill Quality

Plancha & Grill · Grillplatte  
Grill plate · Prancha & Grelhador

Ref	€	W	Temperatura	Medidas	U.Venta
69227	86,70	2000	230°C	61x32,5x6 cm (sin regulador)	1

# Plancha grill Due

new



Household use

- Amplia superficie de cocción de 50x30 cm dividida en dos zonas: grill y lisa.
- Placa antiadherente extraíble de máxima calidad, 100% libre de PFOA.
- Distribución homogénea del calor en toda la superficie de cocción.
- Diseñada para cocinar tanto en interior como en exterior.
- Protector anti-salpicaduras y viento fabricado en acero inoxidable.
- Dos termostatos regulables e independientes con 5 posiciones de temperatura.
- Bandeja recoge grasas extraíble.

- Grande surface de cuisson de 50 x 30 cm divisée en deux zones : grill et lisse.
- Plaque antiadhérente amovible de la plus haute qualité, 100 % sans PFOA.
- Distribution uniforme de la chaleur sur toute la surface de cuisson.
- Conçue pour la cuisson à l'intérieur et à l'extérieur.
- Protection contre les éclaboussures et le vent en acier inoxydable.
- Deux thermostats indépendants réglables avec 5 niveaux de température.
- Bac à graisse amovible.

- Large 50x30 cm cooking surface divided into two areas: grill and smooth.
- Removable high quality non-stick hotplate, 100% PFOA free.
- Even heat distribution over entire cooking surface.
- Designed for both indoor and outdoor use.
- Stainless steel splash and wind guard.
- Two individual adjustable thermostats with 5 temperature settings.
- Removable grease drip tray.

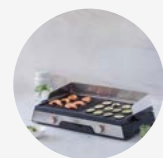

## Plancha grill Due

Planche grill · Grillplatte  
Grill plate · Prancha grelhador

Ref	€	W	Temperatura	Medidas	U.Venta
69570	174,60	2400	220°C	57 x 32,5	1



# Raclette grill



Household use

- Raclette fabricado con carcasa de acero inoxidable y placa de aluminio fundido con antiadherente de máxima calidad. Libre de PFOA.
- Placa reversible que dispone de una superficie acanalada y otra lisa. Superficie de cocción de 41x20 cm.
- Ajuste de temperatura variable (hasta 210°C) con anillo luminoso.
- Resistencia de 1400W distribuida uniformemente por toda la superficie para un calentamiento rápido y uniforme de los alimentos.
- 8 sartenes individuales con revestimiento esmaltado diferenciados por colores. Libres de PFOA.
- 8 espátulas de madera de haya para remover los alimentos y facilitar el momento de servir.
- Protección contra sobrecalentamiento.
- Fácil de limpiar; placa y sartenes extraíbles.

- Raclette fabriqué avec un boîtier en acier inoxydable et une plaque en aluminium fondu avec une qualité supérieure antiadhésive. PFOA gratuit.
- Plaque réversible qui a une surface rainurée et une autre lisse. Surface de cuisson de 41x20 cm.
- Réglage de la température variable (jusqu'à 210°C) avec un anneau léger.
- 1400W Résistance distribuée uniformément dans la surface pour un chauffage alimentaire rapide et uniforme.
- 8 Pans individuels avec revêtement émaillé différencié par les couleurs. Libre de PFOA.
- 8 spatules en bois de hêtre pour enlever les aliments et faciliter le temps de servir.
- Protection de surchauffe. Facile à nettoyer; Assiette amovible et casseroles.

- Raclette manufactured with stainless steel housing and molten aluminum plate with top quality nonstick. PFOA free.
- Reversible plate that has a grooved surface and another smooth. Cooking surface of 41x20 cm.
- Variable temperature adjustment (up to 210°C) with light ring.
- 1400W resistance distributed evenly throughout the surface for rapid and uniform food heating.
- 8 individual pans with enameled coating differentiated by colors. Free from PFOA.
- 8 beech wood spatulas to remove food and facilitate the time to serve.
- Overheating protection. Easy to clean; removable plate and pans.



Termostato regulable  
Adjustable thermostat



8 sartenes individuales  
8 individual frying pans



Apta hasta 8 personas  
Suitable up to 8 people



Plancha y parrilla reversibles.  
Reversible flat and grill plate.



## Raclette grill

Raclette Grill · Raclette-Grill  
Grill raclette · Raclette Grill

Ref	€	W	Temperatura	Medidas	U.Venta
69348	94,10	1400	210°C	48x37,5x14,5 cm	1



## Grill abatible Totally & Controlle

INOX    Household use

- Diseñados para preparar sándwiches, paninis, verdura, carne, etc.
- 69572 - DualFunction: grill y plancha de asar; apertura 180° para aprovechar al máximo la superficie de cocinado doble.
- 69573 - Regulador de altura en 4 posiciones: ideal para alimentos delicados. Regulador de temperatura: regula la potencia de las placas para conseguir la cocción deseada (240°C máx).
- Placas de aluminio fundido antiadherente de máxima calidad, ECO y 100% libres de PFOA.
- Disponen de una bandeja de goteo extraíble apta para el lavavajillas.
- GreenLed: indicador luminoso de temperatura.
- TotalSafe: sistema antiquemadura. La carcasa y el asa permanecen fríos durante el uso

- Conçu pour préparer sandwichs chauds, paninis, légumes, viandes, etc.
- 69572 - DualFunction : grill et plancha ; ouverture à 180° pour exploiter au maximum la surface de cuisson double.
- 69573 - Réglage en hauteur en 4 positions : Idéal pour les aliments délicats. Régulateur de température : Régle la puissance des plaques pour obtenir la cuisson souhaitée (240°C max.).
- Plaques en fonte d'aluminium antiadhésif de la plus grande qualité, ECO et 100% sans PFOA.
- Dispose d'un plateau recueille-gouttes extractible apte pour le lave-vaisselle.
- GreenLed: indicateur de température lumineux.
- TotalSafe : système anti-brûlures. La carcasse et la poignée restent froides pendant son utilisation.

- Designed to prepare sandwichs, paninis, vegetables, meat, etc.
- 69572 - DualFunction: Grill and griddle; fully opens 180° to maximise use of the double cooking area
- 69573 - Height adjustment in 4 positions: ideal for delicate foods. Temperature control: regulates heat of the hotplates to achieve the desired degree of doneness (240°C max.).
- Non-stick cast aluminium hotplates of the highest quality, ECO and 100% PFOA free.
- Features a removable, dishwasher-safe drip tray.
- GreenLed: temperature indicator light.
- TotalSafe: anti-burn system. Housing and handle remain cool during use.



### Grill abatible Totally

Grill rabattable · Klappgrill  
Contact grill · Grelhador abatível

Ref	€	W	Temperatura	Área de cocción	Medidas	U. Venta
69572	52,80	1500	180°C	26x16,5 cm (x2)	32x27x11 cm	1

### Grill abatible Controlle

Grill rabattable · Klappgrill  
Contact grill · Grelhador abatível

Ref	€	W	Temperatura	Área de cocción	Medidas	U. Venta
69573	98,10	1500	240°C	27x17,5 cm	33,5x28x12,5 cm	1



### Grill abatible Pro

Grill rabattable · Klappgrill  
Contact grill · Grelhador abatível

Ref	€	W	Temperatura	Superficie placa	Medidas	U. Venta
69574	268,70	2000	230°C	27x22 cm	38x35x17 cm	1



- Grill de gran calidad y robusto para uso profesional.
- Placas extraíbles de aluminio fundido antiadherente de gran calidad, libre de PFOA.
- Doble zona de cocción: 1) Grill (27x22 cm): ideal para asar carnes, pescados, marisco, hamburguesas o verduras. 2) Lisa (27x22 cm): ideal para preparar tortitas, huevos, tostadas o verduras.
- Alcanza rápidamente la temperatura indicada. Garantiza una cocción uniforme por toda la superficie.
- Regulación en altura. Regulador de potencia y temporizador de 30 minutos.
- Fácil extracción (botón) y colocación de las placas para facilitar su limpieza.
- Bandeja recoge grasas. Base antideslizante.
- Incluye espátula para la limpieza de las placas.

- Grill of great quality and robust for professional use.
- Removable molten aluminum plates of great quality, free of PFOA.
- Double cooking zone: 1) grill (27x22 cm): Ideal for roasting meats, fish, seafood, hamburgers or vegetables. 2) Lisa (27x22 cm): Ideal for preparing pancakes, eggs, toast or vegetables.
- Quickly reaches the indicated temperature. It guarantees a uniform cooking throughout the surface.
- Height regulation. 30 -minute power regulator and timer.
- Easy extraction (button) and plates placement to facilitate cleaning.
- Town collects fats. Non -slip base
- Includes spatula for cleaning the plates.

### Professional use

A



B



- Plancha grill profesional con estructura de acero inoxidable y placas de hierro colado.
- Ideal para preparar carnes, pescados, verduras, bocadillos, etc.
- Placa superior (simple o doble) regulable en altura y abatible hasta 90°.
- Mango aislante térmico.

- Professional griddle with stainless steel structure and cast iron plates.
- Ideal for preparing meat, fish, vegetables, sandwiches, etc.
- Upper plate (single or double) adjustable in height and tiltable up to 90°.
- Thermal insulating handle.

### Plancha Grill profesional

Grill · Grill  
Grill · Grelhar

Ref	€	W	Temperatura	Medidas	U. Venta
A 69166	476,70	2200	50-300°C	31x31x20 cm	1 Simple
B 69167	744,00	4400	50-300°C	57x31x20 cm	1 Doble · Double



## Sandwicheras



Household use

- Tuesta y sella 2 sándwiches al mismo tiempo y consigue resultados increíbles.
- Placas con revestimiento antiadherente de alta calidad y libres de PFOA.
- Asa termorresistente. Manipula la sandwichera con la máxima seguridad.
- Calentamiento rápido y uniforme. Indicadores led de encendido y calentamiento.
- Sistema de cierre y bloqueo sencillo y seguro.
- Compartimento para cable. Posibilidad de almacenamiento vertical.
- Patas de goma antideslizantes.

- Rôtis et sceller 2 sandwichs en même temps et obtenir des résultats incroyables.
- Plaques de haute qualité et antitens libres de PFOA.
- Poignée résistante au thermor. Manipule le sandwichera avec une sécurité maximale.
- Réchauffement rapide et uniforme. Indicateurs LED d'allumage et de chauffage.
- Système de fermeture et de blocage simple et sûr.
- Possibilité de stockage vertical.
- Pignes en caoutchouc non glissantes.

- Roasts and seal 2 sandwiches at the same time and get incredible results.
- High quality and free antiating plates of PFOA.
- Thermor resistant handle. Manipulates the sandwichera with maximum security.
- Fast and uniform warming. LED indicators of ignition and heating.
- Simple and safe closing and blocking system.
- Cable compartment. Possibility of vertical storage.
- Non -slip rubber legs.



### Sandwichera Black

Appareil à sandwichs · Sandwichmaker  
Sandwich toaster · Sanduicheira

Ref	€	W	Medidas placa	Medidas	U.Venta
<b>A</b> 69147	<b>31,60</b>	750	10,5x12,5 cm	25x24x11 cm	1 <b>Rectangular</b>
<b>B</b> 69148	<b>31,60</b>	750	10,5x12,5 cm	25x24x11 cm	1 <b>Triangular</b>

### Sandwichera White

Appareil à sandwichs · Sandwichmaker  
Sandwich toaster · Sanduicheira

Ref	€	W	Medidas placa	Medidas	U.Venta
69247	<b>36,00</b>	750	11x11 cm	23x22x8,5 cm	1



## Gofreras



Ø18 cm del gofre  
Waffle Ø18 cm

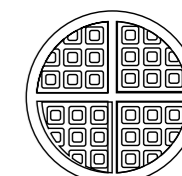

Gofre: Ø20 cm  
Waffle: Ø20 cm



Placas en hierro colado  
Cast iron plates



INOX 18/10 AL FUNDIDO  
Aluminium Cast

**Gofrera Pro**  
Gaufrier · Wendewaffeleisen  
Waffle maker · Maquina de fazer gofres

Ref	€	W	Temperatura	Placa gofre	Medidas	U. Venta
69349	<b>311,50</b>	1000	50-300°C	Ø18 cm	26x44x26 cm	1

AL FUNDIDO  
Aluminium Cast

**Gofrera Reversible**  
Gaufrier réversible · Wendewaffeleisen  
Waffle maker · Maquina de fazer gofres reversível

Ref	€	W	Placa gofre	Medidas	U.Venta
69149	<b>58,70</b>	875	Ø 20 cm	34x24x15 cm	1

## Quemador



- Quemador de azúcar eléctrico redondo con soporte.
- Diseñado para aplicaciones en cocina y repostería profesional.
- Ideal para caramelizar crema.
- Se calienta muy rápido.
- Incluye soporte.

- Brûleur de sucre électrique rond avec soutien.
- Conçu pour les applications dans une cuisine professionnelle et des pâtisseries.
- Idéal pour caraméliser la crème.
- Il se réchauffe très vite.
- Comprend le support.

- Round electric sugar burner with support.
- Designed for applications in professional kitchen and pastries.
- Ideal to caramelize cream.
- It heats up very fast.
- Includes support.

### Quemador eléctrico redondo

Fer à caraméliser électrique rond · Karamellisierer rund  
Round electric caramelizer · Queimador eléctrico redondo

Ref	€	W	Ø (cm)	U.Venta
68651	<b>117,80</b>	650	Ø10	1
68652	<b>136,00</b>	1000	Ø12	1



Incluye soporte  
Includes support



## Creperas



- Crea crepes dulces y salados, pancakes y tortitas de una manera sencilla y cómoda.
- Rapidez, potencia y un calentamiento uniforme.
- Placa de aluminio antiadherente de Ø30 cm, perfecta para hacer crepes de gran tamaño.
- Incluye rastrillo de madera para extender la masa y conseguir un grosor homogéneo y espátula para voltear el crepe.

- Créez des crêpes, des crêpes et des crêpes sucrées et salées de manière simple et confortable.
- Vitesse, puissance et réchauffement uniforme.
- Assiette en aluminium antiférent de Ø30 cm, parfaite pour les grandes crêpes.
- Comprend le râteau en bois pour répandre la pâte et obtenir une épaisseur homogène et une spatule pour tourner la crêpe.

- Create sweet and salty crepes, pancakes and pancakes in a simple and comfortable way.
- Speed, power and uniform warming.
- Antiferent aluminum plate of Ø30 cm, perfect for large crepes.
- Includes wood rake to spread the dough and get a homogeneous thickness and spatula to turn the crepe.

Placa de aluminio antiadherente de Ø40 cm  
Non-stick aluminium plate Ø40 cm



**Placa crepera Pro**  
Plaque crêpière · Crêpes-Kochplatte  
Crepe maker · Placa crepeira

Ref	€	W	Superficie placa	Medidas	U.Venta
69196	502,60	3000	Ø 35 cm	45x49x22,5 cm	1

Placa de aluminio antiadherente de Ø33 cm  
Non-stick aluminium plate Ø33 cm



**Crepera TitanPro**  
Crêpière · Crêpesplatte  
Crepe maker · Crepeira

Ref	€	W	Superficie placa	Medidas	U.Venta
69433	81,40	1500	Ø33	Ø33x7 cm	1

Placa de aluminio antiadherente de Ø30 cm  
Non-stick aluminium plate Ø30 cm



**Crepera Black**  
Crêpière · Crêpesplatte  
Crepe maker · Crepeira

Ref	€	W	Superficie placa	Medidas	U.Venta
69122	56,60	1000	Ø 30 cm	40x36x11 cm	1

## Baño maría chocolate



### Baño maría chocolate Black

Bain marie de chocolat · Bain Marie topf für Schokolade  
Chocolate bain marie · Banho-maria chocolate

Ref	€	W	L	Temperatura	Medidas	U.Venta
69317	42,80	50	1,0	40-50°C	29 x 22 x 12 cm	1

- Recipiente eléctrico con cazo desmontable de acero inoxidable de gran calidad.
- Dos funciones: fundir el chocolate (40-50°C) y mantenerlo caliente.
- Botón giratorio con 3 posiciones: apagar, fundir y calentar.
- Mantiene la temperatura constante a 40 - 50 grados.

- Récipient électrique avec acier inoxydable amovible en acier inoxydable de haute qualité.
- Deux fonctions: Faire fondre le chocolat (40-50°C) et le garder chaud.
- Bouton rotatif avec 3 positions: éteignez, faites fondre et chauffez.
- Maintenir la température constante à 40 à 50 degrés.

- Electric container with removable stainless steel of high quality stainless steel.
- Two functions: melt the chocolate (40-50°C) and keep it hot.
- Rotating button with 3 positions: turn off, melt and heat.
- Maintain the constant temperature at 40 - 50 degrees.



- Perfecta para elaborar coberturas de alta calidad y mantenerlas a la temperatura deseada durante horas.
- Ideal para la obtención de un glaseado brillante para pasteles, tartas, cake pops, muffins, etc.
- Contenedor GN1/6 (1,50L) y tapa extraíble de acero inoxidable 18/10 para garantizar una rápida y efectiva limpieza (aptos para el lavavajillas).
- Regulación de temperatura por termostato de 0°C a 60°C.
- Calentamiento 3D; el calor se distribuye de manera uniforme por toda la superficie del recipiente.
- Luz indicadora, se enciende tan pronto como se alcanza la temperatura deseada.
- Compatible con cubetas GN1/6 de Lacor

- Perfect to prepare high quality coverage and keep them at the desired temperature for hours.
- Ideal for obtaining a brilliant glaze for cakes, cakes, cake pops, muffins, etc.
- GN1/6 (1.50L) container and removable stainless steel cover 18/10 to guarantee rapid and effective cleaning (suitable for dishwasher).
- Temperature regulation by thermostat from 0°C to 60°C.
- 3D heating; The heat is distributed uniformly throughout the surface of the container.
- Indicator light, comes as soon as the desired temperature is reached.
- Compatible with Gn1/6 buckets from Lacor



### Baño maría chocolate White

Bain marie de chocolat · Bain Marie topf für Schokolade  
Chocolate bain marie · Banho-maria chocolate

Ref	€	W	L	Temperatura	Medidas	U.Venta
69617	77,60	80	1,5	60°C	22,6x26x14,3 cm	1





# Fondue

INOX 18/10 CE  Household use



- Fondue eléctrica acabada en acero inoxidable de gran calidad. 1500W de potencia.
- Ideal para fundir queso, chocolate o calentar aceite.
- Olla de acero inoxidable desmontable y de 1,2 L de capacidad con fondo termodifusor para una distribución uniforme del calor.
- Termostato regulable para calentar y mantener los ingredientes siempre calientes.
- Protector antisalpicaduras extraíble con soporte para 8 tenedores.
- Incluye 8 tenedores de acero inoxidable y marcas de colores.
- Apagado de seguridad contra sobrecalentamiento.
- Pies antideslizantes. 100% estable.
- Olla, protector y tenedores aptos para el lavavajillas.

- High quality stainless steel electric fondue set. 1500 W power.
- Ideal for melting cheese, chocolate or heating oil.
- 1.2 L removable stainless steel pot with thermo-diffuser bottom for even heat distribution.
- Adjustable thermostat to heat and keep the ingredients hot at all times.
- Removable splash guard lid that holds 8 forks.
- Includes 8 stainless steel colour marked forks.
- Overheating safety function.
- Non-slip feet. 100% stable.
- Dishwasher safe pot, lid and forks.



**Fondue Grey Plus**  
Fondue · Fondue  
Fondue · Fonduel

Ref	€	W	Temperatura	L	Medidas	U.Venta
69399	101,90	1500	40°C - 95°C	1,20	29,5x21x24,5 cm	1

# Chocolatera

INOX CE  Professional use



- Chocolatera profesional diseñada para mezclar y calentar chocolate al baño maría.
- Cubeta de policarbonato de 5 litros de capacidad.
- Termostato regulable de 0°C a 90°C.
- Sensor para prevenir posibles sobrecalentamientos.
- Sistema NonStop: movimiento continuo para conseguir resultados sin grumos y de consistencia perfecta.
- Grifo con sistema antigoteo y antiobstrucción, totalmente desmontable.
- Ideal para bares, restaurantes, cafeterías, hoteles, catering, foodtrucks, etc.
- Bandeja antigoteo con sistema de aviso.
- Base antideslizante. Fácil limpieza.

- Professional chocolatera designed to mix and heat chocolate in the water bath.
- 5 -liter capacity polycarbonate bucket.
- Adjustable thermostat from 0°C to 90°C.
- Sensor to prevent possible overheating.
- Nonstop System: Continuous movement to achieve results without lumps and perfect consistency.
- Tap with anti -tote and anti -obstruction system, totally removable.
- Ideal for bars, restaurants, coffee shops, hotels, catering, foodtrucks, etc.
- Anti -tote tray with warning system.
- Non -slip base Easy cleaning.



**Chocolatera Chocosweet**  
Chocolatière · Schokoladenkocher  
Chocolate machine · Chocolateira

Ref	€	W	L	Medidas	U.Venta
69615	862,90	1000	5,0	28x41x46,5cm	1

# Fuentes chocolate

INOX 18/10 CE  Semiprofessional use



- Fabricada en acero inoxidable 18/10 de gran calidad.
- Crea una cascada de chocolate fundido y lo mantiene caliente para bañar alimentos.
- Ideal para buffet, hoteles, restaurantes, estas y celebraciones.
- Torre de 18 cm de tres niveles.
- Interruptor de calentamiento independiente.
- Base con apoyos antideslizantes.
- Desmontable.

- Fabriqué en acier inoxydable 18/10 de haute qualité.
- Créez une cascade de chocolat coulée et gardez-la chaude pour baigner les aliments.
- Idéal pour le buffet, les hôtels, les restaurants, ceux-ci et les célébrations.
- Tour de 18 cm de trois niveaux.
- Interrupteur de chauffage indépendant.
- Base avec support non glissé.
- Amovible.

- Made of stainless steel 18/10 of high quality.
- Create a cast chocolate cascade and keep it hot to bathe food.
- Ideal for buffet, hotels, restaurants, these and celebrations.
- 18 cm tower of three levels.
- Independent heating switch.
- Base with non -slip support.
- Removable.

**Fuentes Chocolate**  
Fontaine chocolat · Schokoladen Fontäne  
Chocolate fountain · Fonte chocolate

Ref	€	W	Temperatura	Capacidad	Medidas	U.Venta
A 69318	61,70	35	40°C -50°C	0,5L	16,5x16,5x31 cm	1
B 69319	105,00	80	40°C -50°C	1,8L	23x23x56cm	1

# Aerógrafo

INOX CE  Professional use



- Soporte**  
Soporte para aerógrafo de 360° para un uso práctico  
360° airbrush stand for practical use
- Regulador de aire**  
Aumenta y disminuye el caudal de salida  
Increase and decrease the output flow
- Ampolla de recarga Llave**  
Ampolla: recarga de pintura Llave; monta/desmonta la boquilla  
Flask, paint refill  
Spanner, assemble/disassemble the nozzle
- Aerógrafo**  
Genera un fino chorro de pintura para recubrir superficies o realizar dibujos mediante la palanca  
Deposito de 7 ml  
Creates a fine spray of paint for covering surfaces or making drawings by lever  
7 ml tank
- Tubo conector (1,8 m)**  
Manguera textil flexible con dos conexiones que traslada el aire del compresor al aerógrafo  
Flexible cloth hose with two connections that carries air from the compressor to the airbrush

**Aerógrafo con compresor**  
Aérographe avec compresseur · Airbrush Spritzpistole mit Kompressor  
Airbrush with compressor · Aerógrafo com compressor

Ref	€	W	Presión	Caudal	Capacidad	U.Venta
69450	103,20	20	0 - 2 bar	0 - 10 L/min	7ml	1



# Chafing Dish eléctrico

INOX CE  Professional use

- Ideal para el sector de la hostelería, restauración y catering.
- Mantiene la temperatura de los alimentos.
- Más seguro al carecer de llama de los geles.
- Tapa y cubeta extraíble GN 1/1 h=65 mm (8,50 L) fabricados en acero inoxidable de alta calidad. Cuerpo fabricado en polipropileno.
- Termostato regulable (85°C +/-10°C).
- Interruptor de encendido y apagado. Indicador luminoso.
- Protección contra sobrecalentamiento.
- Fácil de transportar gracias a sus asas laterales.
- 6 pies antideslizantes y resistentes para mantener la estabilidad.

- Idéal pour le secteur de l'hospitalité, de la restauration et de la restauration.
- Gardez la température alimentaire.
- Plus sûr, sans la flamme des gels.
- Couvercle amovible et cuvette GN 1/1 h = 65 mm (8,50 L) fabriqués en acier inoxydable de haute qualité. Corps fabriqué en polypropylène.
- Thermostat réglable (85 ° C +/- 10 ° C).
- Affonter et désactiver. Indicateur lumineux.
- Protection de surchauffe.
- Facile à transporter grâce à vos poignées latérales.
- 6 Pieds non glissants et résistants pour maintenir l'établissement.

- Ideal for the hospitality, restoration and catering sector.
- Keep the food temperature.
- Safer lacking the flame of the gels.
- Removable lid and cuvette Gn 1/1 h = 65 mm (8.50 l) Manufactured in high quality stainless steel. Body manufactured in polypropylene.
- Adjustable thermostat (85 ° C +/- 10 ° C).
- Switch on and off. Luminous indicator.
- Overheating protection.
- Easy to transport thanks to your lateral handles.
- 6 non -slip and resistant feet to maintain the establishment.



## Chafing Dish eléctrico

Chafing dish électrique · Elektrische Chafing Dish  
Electric chafing dish · Chafing dish eléctrico

Ref	€	W	L	U.Venta
69336	183,00	900	8,5 L	1

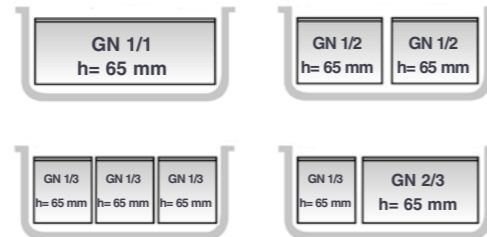

## Calentadores para chafing dish

Corp de chauffe pour bain marie · Heizung für chafing dish  
Heating unit for chafing dish · Aquecedor para chafing dish

Ref	€	W	Temperatura	U.Venta
<b>A</b> 69002	190,70	700	96°C(máx)	1
<b>B</b> 69012	220,60	700	92°C(máx)	1

# Olla calentadora sopa Profesional

CE  Professional use

- Mantiene caliente todo tipo de sopas, salsas, consomés y líquidos.
- Ideal para cantidades grandes.
- Control de temperatura regulable por termostato.
- Cubeta interior desmontable.
- Alta resistencia y durabilidad.

- Maintenir au chaud tout type de soupes, sauces, consommés, liquides, etc.
- Idéal pour de grandes quantités.
- Contrôle de la température réglable par thermostat.
- Seau intérieur amovible.
- Haute résistance et durabilité.

- Keep all kinds of soups, sauces, consommés, liquids etc hot.
- Ideal for large amounts.
- Temperature control adjustable by thermostat.
- Removable inner bucket.
- High resistance and durability.



## Olla calentadora sopa Profesional

Marmite Buffet chaud · Suppen-und Speisenwärmer  
Soup kettle · Panela aquecedora de sopa

Ref	€	W	Temperatura	Capacidad	Medidas	U.Venta
<b>A</b> 69267	297,80	800 W	30°C-90°C	10L	Ø33x32 cm	1Inox 18/10
<b>B</b> 69037	178,70	400 - 475 W	30°C-90°C	11L	Ø34,5 x 36 cm	1Hierro esmaltado
<b>C</b> 69038	251,90	400 - 475 W	30°C-90°C	10L	Ø34,5x36 cm	1Inox



## Repuesto recipiente (69037-69038)

Réceptier de rechange (69037-69038) · Ersatzbehälter (69037-69038)  
Spare container (69037-69038) · Recipiente de reserva (69037-69038)

Ref	€	L	U.Venta
69039	59,70	10	1

# Calentador biberones

INOX    Professional use

- Fabricada en acero inoxidable de alta calidad con aislamiento térmico.
- Sistema de calentamiento en seco y homogéneo.
- Permite mantener calientes las preparaciones previamente elaboradas.
- Cómodo y fácil de usar.
- Termostato regulable de temperatura independiente.
- Incluye 2 botellas de 550 ml de capacidad con 3 boquillas dispensadoras.
- Compatible con nuestras botellas biberón (Ref.: 61974-61977).

- Fabriqué en acier inoxydable de haute qualité avec isolation thermique.
- Système de chauffage sec et homogène.
- Il vous permet de garder les préparatifs précédemment préparés.
- Pratique et facile à utiliser.
- Thermostat à température indépendante réglable.
- Comprend 2 bouteilles de 550 ml de capacité avec 3 buses de distribution.
- Compatible avec nos bouteilles de bouteille (Réf.: 61974-61977).

- Made of high quality stainless steel with thermal insulation.
- Dry and homogeneous heating system.
- It allows you to keep the preparations previously prepared.
- Convenient and easy to use.
- Adjustable independent temperature thermostat.
- Includes 2 bottles of 550 ml capacity with 3 dispensing nozzles.
- Compatible with our bottle bottles (Ref.: 61974-61977).



## Calentador biberones

Chauffe-sauces · Flaschenwärmer  
Squeeze bottle warmer · Aquecedor de garrafas dispensadoras

Ref	€	W	Capacidad	Temperatura	Medidas	U.Venta
69242	251,60	160	550ml x 2	60-80°C	30,5x25x23 cm	1

# Baño María GN 1/1 Profesional

INOX 18/10   Professional use

Combinaciones de cubetas posibles  
Possible tray options

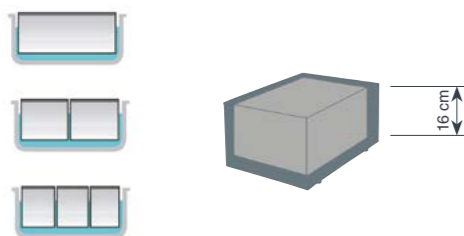

## Baño María GN 1/1 Profesional

Bain-marie en inox GN 1/1 150 mm · Bain Marie, GN 1/1 150 mm, Rostfrei  
St. steel bain-marie GN 1/1 150 mm · Banho-maria GN 1/1 150 mm

Ref	€	W	L	Temperatura	Medidas	U.Venta
69036	239,90	1300	24,0	30-85°C	61,5x29x30 cm	1

# Placas calentamiento

INOX 18/10   Professional use

- Una solución perfecta para profesionales de la hostelería, buffet, eventos, catering, ferias, etc.
- Ideal para mantener los alimentos calientes antes de servirlos en la mesa a la temperatura perfecta.
- Termostato regulable en temperatura.
- Atención: NO cocinar sobre la misma placa.

- Une solution parfaite pour l'hospitalité, les professionnels du buffet, les événements, la restauration, les foires, etc.
- Idéal pour garder les aliments chauds avant de les servir à la table à la température parfaite.
- Thermostat réglable à température.
- ATTENTION: Ne cuisinez pas dans la même assiette.

- A perfect solution for hospitality, buffet professionals, events, catering, fairs, etc.
- Ideal to keep hot food before serving them at the table at the perfect temperature.
- Adjustable thermostat in temperature.
- Attention: Do not cook on the same plate.



## Calentador Buffet 3xGN 1/3

Chauffe · Warmer  
Warmer · Aquecedor

Ref	€	W	Superficie placa	Contenedor	Medidas	U.Venta
69445	102,40	300	53x36 cm	GN 1/3 (x3)	65x38x15,5 cm	1

## Placa calentamiento

Plaque pour Chauffante · Warmhalteplatte  
Warming Plate · Placa aquecimiento

Ref	€	W	Superficie placa	Medidas	U.Venta
69045	95,00	300	53x36 cm	65x38x6,2 cm	1



## Placa calentamiento Vitrocerámica

Plaque vitrocéramique chaleur · Glaskeramikeizplatte  
Hob heating plate · Placa aquecimiento vitrocerámica

Ref	€	W	Superficie placa	Temperatura	U.Venta
69145	210,30	230	55x36,5 cm	60-105°C	1



## Placa calentamiento Vitro Slim

Plaque vitrocéramique chaleur · Glaskeramikeizplatte  
Hob heating plate · Placa aquecimiento vitrocerámica

Ref	€	W	Superficie placa	Temperatura	U.Venta
69446	104,10	230	38x45 cm	60-105°C	1

# Calentador Buffet

INOX   Professional use

- Mantiene los platos a temperatura perfecta durante un tiempo prolongado.
- Estructura de acero inoxidable de alta calidad y resistente.
- Placa calentadora de acero inoxidable con regulación de temperatura entre 40°C - 90°C.
- Lámparas halógenas para garantizar una temperatura homogénea con regulación independiente para cada una de ellas.
- Gardez la vaisselle à température parfaite pendant longtemps.
- Structure en acier inoxydable de haute qualité et résistante.
- Réfonce en acier inoxydable avec régulation de la température entre 40 ° C à 90 ° C.
- Lampes halogènes pour garantir une température homogène avec une régulation indépendante pour chacun d'eux.
- Keep the dishes at perfect temperature for a long time.
- High quality and resistant stainless steel structure.
- Stainless steel heater with temperature regulation between 40°C - 90°C.
- Halogen lamps to guarantee a homogeneous temperature with independent regulation for each of them.
- Highly resistant plexiglass protective screen.

**A** Dual



**B** Triple



## Calentador Buffet

Plaque électrique · Warmhalteplatte  
Electric warming plate · Placa aquecimento elétrico

Ref	€	W (placa)	W (lámpara)	Superficie placa	Medidas	U. Venta
<b>A</b> 69562	<b>533,40</b>	500	2x250W	71x50 cm	78x53x70 cm	1
<b>B</b> 69563	<b>702,80</b>	650	3x250W	99x50 cm	107x53x70 cm	1



Incluye bombillas infrarrojos (Ref.: R69061A)  
Includes infrared heating bulbs

# Lámparas de calentamiento extensibles

AL   Professional use

- Para uso profesional en hostelería.
- Mantiene calientes los platos.
- Calentamiento por infrarrojos.
- Se aconseja mantener la lámpara a 50 - 60 cm de distancia de los platos.
- Incluye bombilla para todas nuestras lámparas de calentamiento.
- Pour un usage professionnel dans la restauration.
- Maintient les plats au chaud.
- Chauffage infrarouge.
- Il est conseillé d'éloigner la lampe de 50 à 60 cm de distance de la vaisselle.
- Comprend une ampoule pour toutes nos lampes chauffantes.
- For professional catering use.
- Keeps the dishes warm.
- Infrared heating.
- It is recommended that the lamp is kept at a distance of 50-60cm from the plates.
- Bulb for all our heating lamps.



# Lámpara calentamiento infrarrojos

  Professional use



AL  
Aluminium

INOX  
18/10

## Lámpara calentamiento infrarrojos

Lampe de chauffage infrarouge · Infrarot Wärmelampe  
Infrared heating lamp · Lampara calor infravermelho

## Lámpara calentamiento infrarrojos Inox

Lampe de chauffage infrarouge · Infrarot Wärmelampe  
Infrared heating lamp · Lampara calor infravermelho

Ref	€	W	Medidas	h(cm)	U. Venta
<b>A</b> 69361	<b>108,00</b>	275	34x33cm	71	1
<b>B</b> 69061	<b>149,40</b>	550	36x45cm	75	1

Ref	€	W	Medidas	h(cm)	U. Venta
<b>C</b> 69263	<b>486,40</b>	275	31x23cm	79	1
<b>D</b> 69264	<b>632,30</b>	550	36x36cm	76	1

## Bombilla infrarrojos

Ampoule infrarouge · Infrarot Glühbirne  
Infrared heating bulb · Lampada infravermelho

Ref	€	W	U. Venta
R69061A	<b>10,10</b>	275	1



## Lámparas de calentamiento extensibles

Lampe de chauffage câble extensible · Infrarot Wärmelampe Kabel ausziehbar  
Infrared heating lamp extensible · Lámpara calor infravermelho cabo extensível

Ref	€	W	U. Venta	
<b>A</b> 69266	<b>130,20</b>	275	1	Lijado · Sanding
<b>B</b> 69365	<b>149,60</b>	275	1	Cromado · Chrome
<b>C</b> 69367	<b>149,60</b>	275	1	Cobre · Copper
<b>D</b> 69359	<b>141,20</b>	275	1	Negra · Black

## Lámparas de calentamiento extensibles cónica

Lampe chauffante extensible conique · Wärmelampe Kabel ausziehbar, konisch  
Conical heating lamp extensible · Lampada de aquecimento ext. cônica

Ref	€	W	U. Venta	
<b>E</b> 69564	<b>134,80</b>	275	1	Lijado · Sanding
<b>F</b> 69566	<b>161,80</b>	275	1	Cromado · Chrome
<b>G</b> 69565	<b>164,60</b>	275	1	Cobre · Copper
<b>H</b> 69576	<b>151,00</b>	275	1	Negra · Black

# Vitrinas



- **Vitrina neutra construida íntegramente en cristal y base de acero inoxidable.**
- **Diseñada para presentar y exponer sobre la barra / mostrador.**
- **Superficie superior curvada para una visión panorámica.**
- **Estante intermedio de cristal templado.**
- **Puerta trasera abatible.**
- **4 pies de goma que garantizan máxima estabilidad.**

- Vitrine neutre construite entièrement dans une base en verre et en acier inoxydable.
- Conçu pour présenter et exposer sur la barre / comptoir.
- Surface supérieure incurvée pour une vue panoramique.
- Étagère en verre trempé intermédiaire.
- Porte arrière pliante.
- 4 pieds en caoutchouc qui garantissent une stabilité maximale.

- Neutral showcase built entirely in glass and stainless steel base.
- Designed to present and expose on the bar / counter.
- Curved upper surface for a panoramic view.
- Intermediate tempered glass shelf.
- Folding rear door.
- 4 rubber feet that guarantee maximum stability.

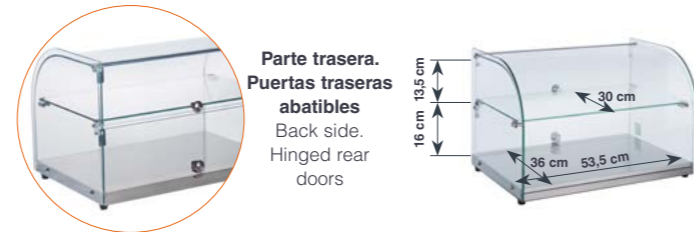

**Parte trasera. Puertas traseras abatibles**  
Back side. Hinged rear doors

CRISTAL INOX  
Glass

## Vitrina neutra

Vitrine neutre · Einfache vitrine  
Clear countertop display case · Vitrina neutra

Ref	€	Capacidad	h(cm)	Medidas	U.Venta
69601	293,10	45L	37	56x37,6x37 cm	1



4  
Cubetas  
Containers

- **Vitrina térmica fabricada en acero inoxidable y cristal.**
- **Diseñada para conservar, presentar y exponer sobre la barra / mostrador.**
- **Puertas correderas para una accesibilidad total.**
- **Superficie superior curvada para una visión panorámica.**
- **Cubetas gastronorm 1/3 incluidas.**
- **Termostato de control de temperatura regulable: 30 - 90°C.**

- Vitrine thermique fabriquée en acier inoxydable et en verre.
- Conçu pour conserver, présenter et exposer sur la barre / comptoir.
- Portes coulissantes pour l'accessibilité totale.
- Surface supérieure incurvée pour une vue panoramique.
- Cubetas Gastronorm 1/3 inclus.
- Thermostat de commande de température réglable: 30 - 90 °C.

- Thermal showcase manufactured in stainless steel and glass.
- Designed to conserve, present and expose on the bar / counter.
- Sliding doors for total accessibility.
- Superior Curvada superior for a panoramic view.
- Gastronorm 1/3 trays included.
- Adjustable temperature control thermostat: 30 - 90°C.



6  
Cubetas  
Containers

CRISTAL INOX  
Glass

## Vitrina térmica con cubetas

Vitrine thermique · Warmhaltevitrine  
Thermal display case · Vitrina térmica

Ref	€	W	Capacidad	Temperatura	Protección	Medidas	U.Venta
A 69602	653,60	500	4x GN 1/3	30°C-90°C	IPX4	77,5x42x33,5 cm	1
B 69603	751,40	800	6x GN 1/3	30°C-90°C	IPX4	113x42x33,5 cm	1



**Parte trasera. Puertas traseras correderas.**  
4 / 6 cubetas gastronorm 1/3 incluidas  
Back side. Sliding rear doors. 4/6 Gastronorm 1/3 trays included

IPX4



IPX4

- **Vitrina térmica fabricada en acero inoxidable y cristal.**
- **Diseñada para conservar, presentar y exponer sobre la barra / mostrador.**
- **Puerta trasera abatible.**
- **Superficie superior inclinada para una visión panorámica.**
- **Recipiente de agua extraíble que aporta humedad en la cámara.**
- **Termostato de control de temperatura regulable: 30-90°C.**
- **Bandeja de rejilla extraíble que facilita el lujo del calor.**

- Vitrine thermique fabriquée en acier inoxydable et en verre.
- Conçu pour conserver, présenter et exposer sur la barre / comptoir.
- Porte arrière pliante.
- Supérieur submergé pour une vue panoramique.
- Récipient d'eau amovible qui apporte l'humidité dans la chambre.
- Thermostat de commande de température réglable: 30-90°C.
- Plateau de grille amovible qui facilite le luxe de la chaleur.

- Thermal showcase manufactured in stainless steel and glass.
- Designed to conserve, present and expose on the bar / counter.
- Folding rear door.
- Superior overwhelmed for a panoramic view.
- Removable water container that brings moisture in the chamber.
- Adjustable temperature control thermostat: 30-90°C.
- Removable grid tray that facilitates the luxury of heat.



**Parte trasera. Puertas traseras abatibles**  
Back side. Hinged rear doors

CRISTAL INOX  
Glass

## Vitrina térmica

Vitrine thermique · Warmhaltevitrine  
Thermal display case · Vitrina térmica

Ref	€	W	Capacidad	Temperatura	Protección	Medidas	U.Venta
69604	592,80	800	45L	30°C-90°C	IPX4	55,5x37,5x37 cm	1



CRISTAL INOX  
Glass

## Vitrina refrigerada

Vitrine réfrigérée · Kühlvitrine  
Refrigerated display case · Vitrina refrigerada

Ref	€	W	Capacidad	Temperatura	Refrigerante	Medidas	U.Venta
69607	1113,60	105	40L	2-12°C	R600a	68x58x34 cm	1

- **Vitrina refrigerada construida íntegramente en cristal y acero inoxidable.**
- **Diseñada para conservar, presentar y exponer sobre la barra / mostrador.**
- **Puertas correderas para una accesibilidad total.**
- **Superficie superior inclinada para una visión panorámica.**
- **Sistema de enfriamiento por compresor. Función Defrost.**
- **Termostato de control de temperatura regulable: 2-12°C.**
- **Sist. de iluminación LED en la cámara interior y display de control de mandos.**

- Vitrine réfrigérée construite entièrement en verre et en acier inoxydable.
- Conçu pour conserver, présenter et exposer sur la barre / comptoir.
- Portes coulissantes pour l'accessibilité totale.
- Surface supérieure inclinée pour une vue panoramique.
- Système de refroidissement du compresseur. Fonction de dégivrage.
- Thermostat de commande de température réglable: 2-12°C.
- Sist. d'éclairage LED dans la chambre intérieure et le contrôle des commandes.

- Refrigerated showcase built entirely in glass and stainless steel.
- Designed to conserve, present and expose on the bar / counter.
- Sliding doors for total accessibility.
- Inclined upper surface for a panoramic view.
- Compressor cooling system. Defrost function.
- Adjustable temperature control thermostat: 2-12°C.
- Sist. of LED lighting in the inner chamber and control of controls.



**Parte trasera**  
Back side



- Vitrina refrigerada construida íntegramente en cristal y acero inoxidable.
- Diseñada para conservar, presentar y exponer sobre la barra / mostrador.
- Puertas correderas para una accesibilidad total.
- Superficie superior curvada para una visión panorámica.
- Sistema de enfriamiento por compresor.
- Cubetas gastronorm 1/3 incluidas.
- Termostato de control de temperatura regulable: 0-12°C.
- Sistema de iluminación LED en la cámara interior y display de control de mandos.

- Vitrine réfrigérée construite entièrement en verre et en acier inoxydable.
- Conçu pour conserver, présenter et exposer sur la barre / comptoir.
- Portes coulissantes pour l'accessibilité totale.
- Surface supérieure incurvée pour une vue panoramique.
- Système de refroidissement du compresseur.
- Cubetas Gastronorm 1/3 inclus.
- Thermostat de commande de température réglable: 0-12°C.
- Système d'éclairage LED dans l'écran de commande de la chambre intérieure et de la commande.

- Refrigerated showcase built entirely in glass and stainless steel.
- Designed to conserve, present and expose on the bar / counter.
- Sliding doors for total accessibility.
- Curved upper surface for a panoramic view.
- Compressor cooling system.
- Gastronorm 1/3 trays included.
- Adjustable temperature control thermostat: 0-12°C.
- LED lighting system in the inner chamber and control control display.



**Control de temperatura regulable**  
Temperature control thermostat

**Puertas traseras correderas**  
Sliding rear doors

INOX CRISTAL Glass

**Vitrina refrigerada con cubetas**  
Vitrine réfrigérée · Kühlvitrine  
Refrigerated display case · Vitrina refrigerada

Ref	€	W	Capacidad	Temperatura	Refrigerante	Medidas	U.Venta
A 69605	1270,50	160	4x GN 1/3	0°C-12°C	R600a	112,1x45x33 cm	1
B 69606	1408,60	160	6x GN 1/3	0°C-12°C	R600a	148,3x45x33 cm	1

### 69602

Combinaciones posibles  
Possible combinations

GN 2/3	GN 2/3		
GN 1/3	GN 1/3	GN 1/3	GN 1/3

### 69603

Combinaciones posibles  
Possible combinations

GN 2/3	GN 2/3	GN 2/3			
GN 1/2	GN 1/2	GN 1/2	GN 1/2		
GN 1/3	GN 1/3	GN 1/3	GN 1/3	GN 1/3	GN 1/3

# Dispensador de agua caliente

INOX BPA free CE Household use



## Dispensador de agua caliente

Distributeur d'eau chaude · Heißwasserspender  
Hot water dispenser · Dispensador de água quente

Ref	€	L	W	Niveles calentamiento	Medidas	U.Venta
69298	127,90	2 L	2400	25°C - 70°C - 85°C - 95°C	32x17x33 cm	1

# Hervidores de Agua

CE BPA free Household use



**Base independiente rotativa de 360°**  
Independent base rotates 360°



**Interior inox 18/10**  
Interior 18/10 st. steel

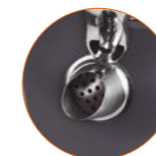

**Boquilla con filtro**  
Nozzle with filter



**Interior inox 18/10.**  
Interior 18/10 st. steel.



INOX 18/10 **Strix** Technology

## Hervidor de agua Retro

Bouilloire électrique · Elektrische Wasserwamer  
Electric kettle · Chaleira eléctrica

CE Ceramic

## Hervidor de agua Gala

Bouilloire en céramique · Keramik Wasserwamer  
Ceramic kettle · Chaleira cerâmica

Ref	€	W	Capacidad	Medidas	U.Venta	Ref	€	W	Capacidad	Medidas	U.Venta
69397	59,80	2200	1,7L	26 x 19,5 x 26,5 cm	1	69276	53,10	1500	1,2L	24 x 17 x 25 cm	1



### Hervidor de agua

Bouilloire · Wasserwamer  
Kettle · Chaleira

Ref	€	W	Capacidad	Medidas	U.Venta
<b>A</b> 69591	<b>23,20</b>	2200	1,3 L	20x15x21 cm	1
<b>B</b> 69590	<b>23,20</b>	2200	1,3 L	20x15x21 cm	1

**Strix**  
Technology



INOX  
18/10

### Hervidor de agua Lake

Bouilloire · Wasserwamer  
Kettle · Chaleira

Ref	€	W	Capacidad	Medidas	U.Venta
69277	<b>61,30</b>	2200	1,7 L	23 x 16 x 23 cm	1



**Fácil llenado**  
Easy filling



**Visor de nivel de agua**  
Water level



### Hervidor de agua Rapid

Bouilloire · Wasserwamer  
Kettle · Chaleira

Ref	€	W	Capacidad	Medidas	U.Venta
69291	<b>40,90</b>	1630	1,0L	22 x 16 x 21 cm	1
69297	<b>51,10</b>	2200	1,7L	22 x 18 x 23 cm	1



**Protección de ebullición en seco**  
Dry boil protection



**Temperatura ajustable de 50°C-95°C**  
Adjustable temperature from 50°C-95°C



50 -  
95°C  
max

CRISTAL  
Glass

### Hervidor de agua Vista

Bouilloire · Wasserwamer  
Kettle · Chaleira

Ref	€	W	Capacidad	Temperatura	Medidas	U.Venta
69292	<b>82,90</b>	2200	1,7 L	50-95°C	23 x 23 x 32 cm	1

## Airpot

INOX Professional use



- Fabricado en acero inoxidable resistente y de alta calidad.
- Calienta y mantiene el agua a una temperatura óptima.
- Dispone de un grifo dispensador con indicador de nivel de líquido.
- Temperatura controlada por termostato con un rango de 60°C a 100°C. Sensor de temperatura en el interior.
- Dispone de asas laterales aislantes del calor para un desplazamiento seguro.
- Fácil sistema de apertura y nivel de indicador de líquido. Con marcas de llenado en su interior.
- Sistema de dispensado cómodo y bandeja de goteo.
- Nota: utilizar solamente con agua.

- Fabriqué en acier inoxydable résistant et de haute qualité.
- Chauffer et garder l'eau à une température optimale.
- Il a un robinet de distributeur avec un indicateur de niveau liquide.
- Température contrôlée par thermostat avec une plage de 60 ° C à 100 ° C. Capteur de température à l'intérieur.
- Il a des poignées latérales isolantes à la chaleur pour un déplacement sûr.
- Système d'ouverture facile et indicateur liquide. Avec des marques de remplissage à l'intérieur.
- Système de distribution confortable et plateau goutte à goutte.
- Remarque: utilisez uniquement avec de l'eau.

- Made of resistant and high quality stainless steel.
- Heat and keep the water at an optimal temperature.
- It has a dispenser tap with liquid level indicator.
- Thermostat controlled temperature with a range of 60°C to 100°C. Temperature sensor inside.
- It has heat-insulating side handles for safe displacement.
- Easy opening system and liquid indicator level. With filling marks inside.
- Comfortable dispensing system and drip tray.
- Note: Use only with water.

### Airpot

Électrique Airpot · Elektrische Getrankenpender  
Electric Airpot · Airpot eléctrico

Ref	€	W	Capacidad	Temperatura	Medidas	U.Venta
69472	<b>134,60</b>	1500	4L	60°C-100°C	28x28x35 cm	1
69476	<b>145,50</b>	1500	6L	60°C-100°C	28x28x40 cm	1
69471	<b>158,80</b>	1500	10L	60°C-100°C	28x28x48 cm	1

## Cafetera Percoladora

INOX Professional use



**Filtro microperforado**  
Micro-perforated filter



- Fabricada en acero inoxidable de gran calidad.
- Ideal para cafeterías, restaurantes, bares, servicios de buffet y estaciones self-service.
- 2 sistemas de calentamiento independientes para la función de infusión y la función de conservación del calor.
- Distribución de calor rápida y homogénea.
- Mantiene el café a la temperatura óptima salvaguardando sus propiedades de sabor y aroma durante horas.
- Filtro de malla microperforada de acero inoxidable, especialmente diseñado para evitar la generación de posos.
- Luz indicadora de preparación. Indicador del nivel de agua. Bandeja antigoteo.
- Tapa con cierre de seguridad mediante botón de bloqueo.
- Sistema de protección contra el calentamiento en vacío.
- Opción de lujo continuo para una máxima comodidad.
- Tapa, filtro y tubo percolador aptos para el lavavajillas.

- Made of high quality stainless steel.
- Ideal for coffee shops, restaurants, bars, buffet services and Self-Service stations.
- 2 independent heating systems for infusion function and heat conservation function.
- Fast and homogeneous heat distribution.
- Keep coffee at the optimal temperature safeguarding its flavor and aroma properties for hours.
- Stainless steel microperforated mesh filter, specially designed to prevent the generation of posos.
- Preparation indicator light. Water level indicator. Antigoteing tray.
- Safety closure cover using lock button.
- Vacuum warming protection system.
- Continuous luxury option for maximum comfort.
- Cover, filter and percolative tube suitable for dishwasher.

### Cafetera Percoladora

Percolateur à café · Kaffee-Perkolator  
Coffee percolator · Máquina/Percolador de café

Ref	€	W	Capacidad	Medidas	U.Venta
69486	<b>167,30</b>	1500	6L	28x28x40 cm	1
69481	<b>186,70</b>	1500	10L	35x35x45 cm	1

# Molinillos

INOX BPA free Dishwasher CE Household use



- Ideal para moler café y otros productos como semillas, hierbas, frutos secos, cereales, sal, pimienta o especias.
- 100% acero inoxidable: cuerpo y cuchillas fabricados en acero inoxidable de máxima calidad.
- Tapa transparente: tapa superior de color transparente para visualizar el grano molido.
- Interruptor ON/OFF: funcionamiento con un simple botón (inicio/parada).
- Interruptor de seguridad: las cuchillas se activan solo cuando la tapa está correctamente cerrada.
- Depósito para 60 g de granos de café molido.
- Almacenamiento para el cable.
- Libre de BPA.

- Ideal for grinding coffee and other products such as seeds, herbs, nuts, cereals, salt, pepper or spices.
- 100% stainless steel: body and blades made of maximum quality stainless steel.
- Transparent lid: upper transparent color lid to display the ground grain.
- On/off switch: operation with a simple button (start/stop).
- Safety switch: The blades are activated only when the lid is correctly closed.
- Deposit for 60 g of ground coffee beans.
- Cable storage.
- BPA free.

## Molinillo de café Limu

Moulin à café · Kaffeemühle  
Coffe grinder · Moedor de café

Ref	€	W	Capacidad contenedor	U.Venta
69385	38,20	200	60 g	1

# Cafeteras de goteo

INOX VIDRIO Glass CE Household use



- Cafetera de goteo programable, permite programar hasta 24 horas antes para tener el café recién echo a la hora deseada.
- Tecnología AromaTech: Disfruta del sabor intenso del café gracias al sistema de rociado y goteo continuo.
- Función KeepWarm: La placa calefactora mantiene el café caliente hasta 40 minutos.
- Filtro reutilizable. También permite usar filtros de papel.
- Pantalla LCD retroiluminada, jarra de cristal termorresistente y depósito con ventana para controlar el nivel del agua en todo momento.
- 900 W de potencia con capacidad de 1,50 litros para preparar hasta 12 tazas de café.
- Incluye cuchara dosificadora para preparar y calcular la cantidad de café.

- Programmable drip coffee maker that can be programmed up to 24 hours in advance to enjoy freshly brewed coffee at the time you want.
- AromaTech technology: enjoy the intense flavour of coffee thanks to the continuous drip and spray system.
- KeepWarm function: the hot plate keeps the coffee hot for 40 minutes.
- Reusable filter. Compatible with paper filters.
- Backlit LCD display, heat-resistant glass jug and tank with window to monitor the water level at all times.
- 900 W power and 1.5 L capacity to brew up to 12 cups of coffee.
- Includes measuring spoon to prepare and calculate the exact amount of coffee.



Mantiene el café caliente hasta 40 min  
Keeps coffee hot for up to 40 min



Tecnología AromaTech Technology

## Cafetera de goteo Drop

Café filtre · Filterkaffee  
Filter coffee machine · Café tipo filtro

Ref	€	W	Capacidad	Medidas	U.Venta
69279	77,40	900	1,5L	20x28x36,5 cm	1



- Puede dosificar la cantidad de café.
- Una vez encendida nos podemos desentender de ella.
- Si la jarra se completa, mantiene el café caliente y se puede consumir en cualquier momento.

- Vous pouvez dose la quantité de café.
- Une fois que vous pouvez le ignorer.
- Si la cruche est terminée, gardez le café chaud et peut être consommé à tout moment.

- You can dose the amount of coffee.
- Once you can disregard it.
- If the jug is completed, keep the coffee hot and can be consumed at any time.



## Cafetera de goteo Black

Cafetière filtre électrique · Filter-Kaffeemaschine  
Filter coffe machine · Café tipo filtro

Ref	€	W	Capacidad	Tazas	Medidas	U.Venta
69278	55,20	1000	1,25L	10	31x21x22 cm	1

## Professional use



## Máquina de café Auto

Machine à café automatique · Automatische Kaffeemaschine  
Automatic coffee machine · Máquina automática do café

Ref	€	W	Capacidad	Medidas	U.Venta
69272	509,20	2100 W	1,8L x 2	20x36x41 cm	1



## Pack 200 filtros

Pack 200 filtros · Pack200 Filter  
Pack filters U.Venta · Pack 200 filtros

Ref	€	Ø (cm)	U.Venta
69274	16,90	25	1
69275	14,50	20	1



## Placa calentamiento jarra café

Plaque chauffante pour cruche de café · Heizplate für Kaffeekanne  
Heating plate for coffee jug · Placa de aquecimento caneca de café

Ref	€	W	Ø Placa	Temperatura	Medidas	U.Venta
69282	121,70	180	11	80°C	38x20,5x7 cm	1



## Jarra café Cristal

Basse en verre pichet · Glass Kaffee Krug  
Glass coffee jug · Caneca de café em vidro

Ref	€	Capacidad	U.Venta
69273	29,90	1,8L	1



# Cafetera Superautomática Sabore

new



Household use



- Cafetera superautomática compacta y diseñada para los amantes del café recién molido.
- Disfruta del café recién hecho con grano molido.
- Se puede ajustar la cantidad de café para cada una de las 3 funciones.
- Molinillo ajustable de muelas cónicas: 15 niveles de molienda. Ajusta el grano de molienda a tu gusto.
- Gran capacidad: Hasta 180 gramos de café y depósito de agua de 1,5L.
- Calentamiento ThermoBlock: Sistema eléctrico de calentamiento del agua ultra rápido. Disfruta de un café recién molido al instante.
- Doble salida de café regulable en altura desde 8,5 cm hasta 11,5 cm.
- AutoClean System: Sistema de limpieza automático.
- Molinillo y depósito para residuo totalmente accesible: facilita su limpieza.
- Incluye vaporizador para calentar y espumar la leche o calentar agua para infusiones.
- Pantalla intuitiva táctil.

- Compact superautomatic coffee machine designed for lovers of freshly ground coffee.
- Enjoy freshly brewed coffee with ground beans.
- The amount of coffee can be adjusted for each of the 3 functions.
- Adjustable conical grinder: 15 grinding levels. Adjust the grind to your taste.
- Large capacity: Up to 180 grams of coffee and 1.5L water tank.
- ThermoBlock heating: Ultra-fast electric water heating system. Enjoy freshly ground coffee instantly.
- Double coffee spout adjustable in height from 8.5 cm to 11.5 cm.
- AutoClean System: Automatic cleaning system.
- Fully accessible grinder and waste container: easy to clean.
- Includes frother for heating and frothing milk or heating water for infusions.
- Intuitive touch screen

## Cafetera automática Sabore

Machine à café automatique · Automatische Kaffeemaschine  
Automatic coffee machine · Máquina de café automática

Ref	€	W	Capacidad	Capacidad contenedor	Presión	Medidas	U.Venta
69435	554,10	1350	1,5L	180g	20 bar	44x19x32 cm	1

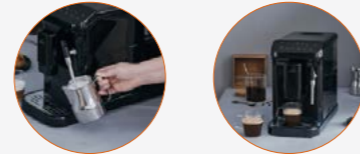

# Cafeteras Espresso



Household use



- Cafetera espresso de acero inoxidable con diseño elegante y compacto.
- Consigue un café perfecto y rápido gracias a su potencia de 1450 W y sus 20 bares de presión.
- Su sistema de calentamiento rápido Thermoblock calienta el agua en segundos.
- Función manual y automática. Permite programar el ciclo de vertido a tu gusto.
- Incluye vaporizador con rotación para espumar leche y preparar cappuccino. También dispensa agua caliente para las infusiones.
- Brazo portafiltros con doble salida, te permite preparar uno o dos cafés simultáneamente.
- Depósito de agua extraíble de 1,25 litros de capacidad con marcas de máximo y mínimo. Libre de BPA.
- Incluye cucharilla dosificadora con prensador para el café y 3 filtros (individual, doble y para usar cápsulas ESE) para acoplar al brazo de la cafetera.
- Bandeja de goteo desmontable con indicador de nivel para facilitar la limpieza.
- Sistema de ahorro energético con apagado automático.

- Espresso stainless steel cafeter with elegain and compact design
- Get a perfect and fast coffee thanks to its power of 1450 W and its 20 pressure bars.
- Your fast heating system Thermoblock heats the water in seconds.
- Manual and automatic function. Allows you to program the dumping cycle to your liking.
- Includes rotation vaporizer for foam milk and prepare cappuccino. It also dispenses hot water for infusions.
- Double outlet portfiltros arm, allows you to prepare one or two coffees simultaneously.
- Removable water tank of 1.25 liters capacity with maximum and minimum marks. BPA free.
- Includes dosing teaspoon with coffee presser and 3 filters (individual, double and to use that) to attach to the coffee maker.
- Removable drip tray with level indicator to facilitate cleaning.
- Energy savings system with automatic shutdown.

INOX

## Cafetera espresso Compact

Cafetière espresso · Espresso-Maschine  
Espresso coffee maker · Cafeteira espresso

Ref	€	W	Capacidad	Presión	Medidas	U.Venta
69429	235,20	1450	1,25L	20 bar	14x31x31 cm	1



INOX

## Cafetera espresso Sence

Cafetière espresso · Espresso-Maschine  
Espresso coffee maker · Cafeteira espresso

Ref	€	W	Capacidad	Presión	Medidas	U.Venta
69256	189,20	850	1,5L	15 bar	21x26,5x30 cm	1



- Cafetera espresso de acero inoxidable con diseño elegante y compacto.
- Ideal para preparar todo tipo de cafés, espresso, cappuccino, latte machiato, té o infusiones.
- Café perfecto y rápido gracias a su potencia y sus bares de presión.
- Sistema de calentamiento rápido Thermoblock, calienta el agua en segundos.
- Fácil de usar, muy intuitiva. Indicadores luminosos en cada función.
- Función manual y automática. Permite programar el ciclo de vertido a tu gusto.
- Incluye vaporizador con rotación para espumar leche, preparar cappuccinos y también dispensar agua caliente para las infusiones.
- Brazo portafiltros con doble salida; te permite preparar uno o dos cafés simultáneamente.
- Depósito de agua extraíble con marcas de máximo y mínimo. Libre de BPA.

- Stainless steel espresso machine with elegant and compact design.
- Ideal to prepare all kinds of coffees, espresso, cappuccino, late machiato, teas or infusions.
- Perfect and fast coffee thanks to its power and pressure bars.
- Thermoblock fast heating system, heats the water in seconds.
- Easy to use, very intuitive. Luminous indicators in each function.
- Manual and automatic function. Allows you to program the dumping cycle to your liking.
- Includes rotation vaporizer for milk foam, prepare cappuccinos and also dispense hot water for infusions.
- Portafiltros arm with double outlet; It allows you to prepare one or two coffees simultaneously.
- Removable water tank with maximum and minimum marks. BPA free.

INOX

## Cafetera Espresso Pro

Cafetière espresso · Espresso-Maschine  
Espresso coffee maker · Cafeteira espresso

Ref	€	W	Capacidad	Capacidad contenedor	Presión	Medidas	U.Venta
69428	659,40	1550	2,8L	250 g (café/Coffee)	20 bar	31x34,5x41,5 cm	1



- Fabricada en acero inoxidable con acabado pulido.
- Molinillo con fresa cónica de acero inoxidable integrado, proporciona la cantidad necesaria de café.
- Depósito de café de 250 g con opción de regular entre 30 tipos de molido. Libre de BPA.
- Control de temperatura PID. Alcanza la temperatura de extracción óptima.
- Función manual y automática. Permite programar la cantidad de vertido a tu gusto.
- Incluye vaporizador con rotación para espumar la leche y preparar cappuccino. También dispensa agua caliente para las infusiones.
- Brazo portafiltros con doble salida; te permite preparar uno o dos cafés simultáneamente.
- Depósito de agua extraíble de 2,8 litros de capacidad con marcas de máximo y mínimo. Libre de BPA.
- Incluye prensador de acero inoxidable para el café, 2 filtros (individual y doble) para acoplar al brazo de la cafetera y jarra de acero inoxidable de 0,46 L para la leche.

- Made of stainless steel with polished finish.
- Milling with conical stainless steel strawberry integrated, provides the necessary quantity of coffee.
- 250 g coffee tank with an option to regulate between 30 types of ground. BPA free.
- PID temperature control. Reach the optimal extraction temperature.
- Manual and automatic function. It allows to program the amount of discharge to your liking.
- Includes rotation vaporizer to foam milk and prepare cappuccino. It also dispenses hot water for infusions.
- Portafiltros arm with double outlet; It allows you to prepare one or two coffees simultaneously.
- Removable water tank of 2.8 liters of capacity with maximum and minimum marks. BPA free.
- Includes stainless steel presier for coffee, 2 filters (individual and double) to attach the coffee maker and 0.46 l stainless steel jug for milk.

# Espumadores de leche

CE  Household use



Calentar y espumar.  
Espumar leche fría  
Heat and froth. Froth cold milk



Calentar  
Heat



## Espumador de leche Latte

Mousseur à lait · Milchaufschäumer  
Milk frother · Espumador de leite

Ref	€	W	Capacidad	Capacidad espuma	Medidas	U. Venta
69396	63,50	500	240ml	115 ml	Ø10x21 cm	1

## Espumador de leche Magnetic

Mousseur à lait · Milchaufschäumer  
Milk frother · Espumador de leite

Ref	€	W	Capacidad	Capacidad espuma	Medidas	U. Venta
69398	78,90	600	250ml	115 ml	Ø12x19,5 cm	1

# Tostadoras Buffet

INOX 18/10   Professional use



## Tostador Continue

Grille-painl · Toaster  
Toaster · Torradeira

Ref	€	W	Velocidad	Medidas	U. Venta
69065	858,70	1340	0,46-0,73m/mi	42x28,5x42 cm	1
69066	990,40	2240	0,46-0,73m/mi	41,6x36,8x29,5 cm	1



## Tostador Buffet

Grille-painl · Toaster  
Toaster · Torradeira

Ref	€	W	Ranuras	Medidas	U. Venta
69294	237,00	1800 W	4	30x24,5x21,5 cm	1
69296	314,80	2500 W	6	43,5x26x22 cm	1



## Tostador Horizontal

Grille-painl · Toaster  
Toaster · Torradeira

Ref	€	W	Tiempo	Número de lámparas	Grill	Medidas	U. Venta
A 69172	364,00	2400	0-15 min	6	40x24 cm	50x29x28cm	1
B 69173	430,20	3600	0-15 min	9	40x24 cm	50x29x37,5cm	1

# Tostadoras

INOX   Household use



## Tostadora Smart

Grille-pain · Toaster  
Toaster · Torradeira

	Ref	€	W	Ranuras	Medidas ranura	Medidas	U. Venta
A	69440	74,90	1500	2	3,8x25 cm	40,3x17,8x19 cm	1
B	69442	63,80	800	2	3,8x14 cm	29,3x17,7x19 cm	1
C	69444	89,90	1750	4	3,8x14 cm	28,8x31,5x19 cm	1



## Tostadora Long

Grille-pain · Toaster  
Toaster · Torradeira

Ref	€	W	Ranuras	Medidas ranura	Medidas	U. Venta
69260	59,20	1400	2	25x4 cm	38x18x20 cm	1



## Tostadora Duplo

Grille-pain · Toaster  
Toaster · Torradeira

Ref	€	W	Ranuras	Medidas ranura	Medidas	U. Venta
69360	65,40	1000	1	25 cm	41x12x18,5 cm	1



## Tostadora Curve

Grille-pain · Toaster  
Toaster · Torradeira

	Ref	€	W	Ranuras	Medidas ranura	Medidas	U. Venta
F	69062	53,20	1000	2	14x4 cm	19x29x19 cm	1
G	69064	80,10	1750	4	14x4 cm	33x29x19 cm	1



Basic



Easy

## Tostadora Horizontal

Toaster horizontal · Horizontal-/Toaster  
Electric toaster · Torradeira horizontal

	Ref	€	W	Número de lámparas	Grill	Medidas	U. Venta
D	69163	33,90	600	2	25x20 cm	36x21x6,5 cm	1
E	69363	42,40	600	2	25x20 cm	42x30x9 cm	1

# Exprimidor profesional

CE  Professional use

- Cuenta con una potencia potente y materiales de gran calidad para que puedas exprimir todo tipo de frutas y cítricos.
- Sistema de puesta en marcha automático al presionar la palanca.
- Cono de acero inoxidable extraíble, apto para el lavavajillas hasta 90°C.
- Tiempo máximo en funcionamiento continuo: 30 minutos.

- Sa puissance et ses matériaux de haute qualité vous permettent de presser toutes sortes de fruits et d'agrumes.
- Système de mise en service automatique lorsque vous appuyez sur le levier.
- Côneau en acier inoxydable amovible, adapté au lave-vaisselle jusqu'à 90 ° C.
- Temps maximum en fonctionnement continu: 30 minutes.

- It has a powerful power and high quality materials so you can squeeze all kinds of fruits and citrus fruits.
- Automatic commissioning system when pressing the lever.
- Removable stainless steel cone, suitable for dishwasher up to 90°C.
- Maximum time in continuous operation: 30 minutes.



AL INOX  
Aluminium 18/10

**Exprimidor profesional Inox**  
Presse-fruits professionnelle · Profi-Zitruspresse  
Professional squeezer · Espremedor professional

Ref	€	W	Velocidad	Medidas	U.Venta
69283	447,20	230	980 rpm	28x20x40 cm	1



FE  
Iron

**Exprimidor profesional Black**  
Presse-fruits professionnelle · Profi-Zitruspresse  
Professional squeezer · Espremedor professional

Ref	€	W	Velocidad	Medidas	U.Venta
69286	224,40	180	1350 rpm	31x22x35 cm	1

# Exprimidor Automático

ABS   Household use



**Exprimidor totalmente automático, gracias a su innovadora tecnología la fruta se exprime pulsando solo un botón**  
This totally automatic juicer squeezes fruit with the touch of a button.



**Exprimidor automático**  
Presse-agrumes automatique · Automatische Saftpresse  
Automatic juicer · Espremedor automático

Ref	€	W	Capacidad	Medidas	U.Venta
69520	84,90	60	400ml	20x19x31 cm	1

532

# Exprimidor de Zumo

PP INOX *Household use*  
Polypropylene



**Exprimidor de palanca Vitaly**  
Presse-fruit · Zitruspresse  
Orange squeezer · Espremedor de sumos

Ref	€	W	Medidas	U.Venta
A 69120	96,80	160	19,5x29x29 cm	1
B 69231	129,90	160	19,5x29x29 cm	1



**Exprimidor de zumos Power**  
Presse-fruit · Zitruspresse  
Orange squeezer · Espremedor de sumos

Ref	€	W	Medidas	U.Venta
69280	56,30	100	Ø14,5x25 cm	1



**Exprimidor de palanca Energy**  
Presse-fruit · Zitruspresse  
Orange squeezer · Espremedor de sumos

Ref	€	W	Medidas	U.Venta
69285	67,90	100	Ø 20 x 30 cm	1



**Exprimidor de zumos Spirit**  
Presse-fruit · Zitruspresse  
Orange squeezer · Espremedor de sumos

Ref	€	W	Medidas	U.Venta
69287	68,60	100	18x16,5x25 cm	1



**Exprimidor de zumos Zitrus**  
Presse-fruit · Zitruspresse  
Orange squeezer · Espremedor de sumos

Ref	€	W	Capacidad	Medidas	U.Venta
69575	24,40	40	750ml	Ø19x20,5 cm	1

533

# Licadoras

INOX PP AS CE  
Polypropylene Plastic



## Professional use

- Fabricada en acero inoxidable de alta calidad muy robusta y potente.
- Diseñada para uso continuo.
- Su potente motor, su gran velocidad y su gran orificio de entrada permiten preparar de forma rápida nutritivos zumos de frutas o verduras con expulsión automática de la pulpa.
- Contenedor de residuos de gran tamaño.
- Mecanismo de cierre con interruptor de seguridad.
- Filtro microperforado de acero inoxidable.
- Componentes desmontables fáciles de limpiar.

- Fabriqué en acier inoxydable de haute qualité très robuste et puissant.
- Conçu pour une utilisation continue.
- Son moteur puissant, sa grande vitesse et son grand trou d'entrée permettent de préparer rapidement des jus de fruits nutritifs ou des légumes avec une expulsion automatique de la pulpe.
- Grand récipient à déchets.
- Mécanisme de clôture avec commutateur de sécurité.
- Filtre microperforé en acier inoxydable.
- Composants amovibles faciles à nettoyer.

- Made of high quality stainless steel very robust and powerful.
- Designed for continuous use.
- Its powerful engine, its great speed and its great entry hole allow to quickly prepare nutritious fruit juices or vegetables with automatic pulp expulsion.
- Large waste container.
- Closing mechanism with safety switch.
- Stainless steel microperforated filter.
- Removable components easy to clean.

### Licadora Profesional Pro

Centrifugeuse professionnel · Professioneller zitrus entsafter  
Professional juice extractor · Liquidificador profesional

Ref	€	W	Par motor	Capacidad contenedor	Ø (cm)	Medidas	U.Venta
69488	1170,20	700	2,9 Nm	6 L (residuos)	9 (entrada)	47,3x25,3x52,2 cm	1



### Licadora Ecolo

Fruit centrifugeuse · Zitrus entsafter  
Juice extractor · Liquidificador de zumos

Ref	€	W	Velocidad	Capacidad contenedor	Medidas	U.Venta
69373	422,40	240	60 rpm	10L	29x20x44 cm	1

## Household use

- Tecnología "SLOW": Mediante el sistema de rotación lenta y el método de prensado en frío, permite obtener todos los nutrientes de frutas y verduras a diferencia de los exprimidores tradicionales. Ultrasilencioso gracias a su motor de bajas revoluciones.
- Mezcla frutas y verduras en el interior del recipiente antes de verterlo en la jarra.
- Introduce los ingredientes enteros permitiendo acelerar el tiempo dedicado a la extracción del zumo.
- Fácil limpieza. Cepillo para limpiar las partes internas. Accesorios aptos para el lavavajillas.

- Technologie «lente»: Grâce au système de rotation lent et à la méthode de pressage à froid, il permet d'obtenir tous les nutriments des fruits et légumes contrairement aux polistes traditionnels. Ultrasilencioso grâce à son moteur à faible révolution.
- Mélanger les fruits et légumes à l'intérieur du récipient avant de le verser dans la cruche.
- Entrez l'ensemble des ingrédients permettant d'accélérer le temps consacré à l'extraction du jus.
- Nettoyage facile. Badigeonner pour nettoyer les pièces internes. Accessoires adaptés au lave-vaisselle.

- "Slow" technology. Through the slow rotation system and the cold pressing method, it allows to obtain all the nutrients of fruits and vegetables unlike traditional polisters. Ultrasilencioso thanks to its low revolution engine.
- Mix fruits and vegetables inside the container before pouring it into the jug.
- Enter the entire ingredients allowing accelerating the time dedicated to juice extraction.
- Easy cleaning. Brush to clean the internal parts. Accessories suitable for dishwasher.



Incluye RECETARIO  
RECIPE BOOK included

## Household use

- Fabricada en acero inoxidable de alta calidad muy robusta y potente.
- Diseñada para uso continuo.
- Su potente motor, su gran velocidad y su gran orificio de entrada permiten preparar de forma rápida nutritivos zumos de frutas o verduras con expulsión automática de la pulpa.
- Contenedor de residuos de gran tamaño.
- Mecanismo de cierre con interruptor de seguridad.
- Filtro microperforado de acero inoxidable.
- Componentes desmontables fáciles de limpiar.

- Fabriqué en acier inoxydable de haute qualité très robuste et puissant.
- Conçu pour une utilisation continue.
- Son moteur puissant, sa grande vitesse et son grand trou d'entrée permettent de préparer rapidement des jus de fruits nutritifs ou des légumes avec une expulsion automatique de la pulpe.
- Grand récipient à déchets.
- Mécanisme de clôture avec commutateur de sécurité.
- Filtre microperforé en acier inoxydable.
- Composants amovibles faciles à nettoyer.

- Made of high quality stainless steel very robust and powerful.
- Designed for continuous use.
- Its powerful engine, its great speed and its great entry hole allow to quickly prepare nutritious fruit juices or vegetables with automatic pulp expulsion.
- Large waste container.
- Closing mechanism with safety switch.
- Stainless steel microperforated filter.
- Removable components easy to clean.



### Licadora Nutrily

Fruit centrifugeuse · Zitrus entsafter  
Juice extractor · Liquidificador de zumos

Ref	€	W	Par motor	Capacidad contenedor	Ø (cm)	Medidas	U.Venta
69288	100,20	850	0,387 Nm	2 L	7,5 (entrada)	30x20x36 cm	1

INOX CE ROHS Household use



### Procesador de alimentos Soak

Robot culinaire · Küchenmaschine  
Food processor · Processador de alimentos

Ref	€	W	Velocidad	Capacidad	Calentamiento	Medidas	U.Venta
69380	214,20	450	17000 rpm	1,7L	700-900 W	25x21x45 cm	1

- Cocine sopas caseras, salsas, purés, cremas, batidos, zumos, cócteles, etc.
- Saltear ingredientes, cocinar a fuego lento o hervir sopas.
- Mezcla los ingredientes durante el proceso de cocción.
- Pica hielo en menos de 50 segundos y mezcla desde batidos hasta cócteles congelados.

- Cuire les soupes, les sauces, les purés, les crèmes, les milkshakes, les jus, les cocktails, etc.
- Gardez les ingrédients, cuire à feu doux ou faire bouillir les soupes.
- Mélanger les ingrédients pendant le processus de cuisson.
- De la glace à pica en moins de 50 secondes et mélange des milkshakes aux cocktails surgelés.

- Cook homemade soups, sauces, purés, creams, milkshakes, juices, cocktails, etc.
- Save ingredients, cook over low heat or boil soups.
- Mix the ingredients during the cooking process.
- Pica ice in less than 50 seconds and mix from milkshakes to frozen cocktails.

# Batidoras personales



- **Elabora sin esfuerzo batidos, cremas y zumos de fruta y verdura en segundos.**
- **Las cuchillas de acero inoxidable pulverizan las semillas, cortan las pieles y trituran las partes densas e ibrosas de los alimentos hasta el punto de mantener la máxima cantidad de nutrientes.**
- **Funcionamiento muy sencillo, solo hay que presionar la jarra o botón para que el motor active las cuchillas.**
- **Incluye dos jarras de trítan libres de BPA.**

- Faire des broches, des crèmes et des jus de fruits et légumes en quelques secondes.
- Les lames en acier inoxydable vaporisent les graines, coupent les peaux et écrasent les fibres denses et les fibres au point de maintenir la quantité maximale de nutriments.
- Fonctionnement très simple, il vous suffit d'appuyer sur le pot vers le moteur activer les lames.
- Il comprend deux cruches de Tritan sans BPA.

- Make spits, creams and juices of fruit and vegetables in seconds.
- Stainless steel blades spray the seeds, cut the skins and crush the dense and fibrous of food to the point of maintaining the maximum amount of nutrients.
- Very simple operation, you just have to press the jar to the engine activate the blades.
- It includes two jugs of BPA-free tritan.



**2 jarras trítan (0,5/1 L)**  
Two tritan pitchers (0,5/1 L)



## INOX

### Batidora personal Pro

Mixeur personnel · Mini-Standmixer  
Individual blender · Batedeira pessoal

Ref	€	W	Capacidad	Cuchillas	Medidas	U.Venta
69389	102,60	1200	0,5/1L	4	14x14x40,5 cm	1



### Batidora personal Mix & Go

Personnelle mixeur · Personliche mixer  
Personal blender · Misturador pessoal

Ref	€	W	Capacidad	Medidas	U.Venta
69382	51,40	350	300/600ml	12x12x40,5 cm	1



CRISTAL  
Glass

### Batidora personal Mix & Go con jarra de cristal

Mixeur personnel MIX & GO avec bol en verre · Mini-Standmixer MIX & GO mit Glasbehälter  
MIX & GO individual blender with glass jug · Batedeira pessoal MIX & GO com jarra de vidro

Ref	€	W	Capacidad	Medidas	U.Venta
69386	47,90	350	500ml	Ø12x31 cm	1

**Apta para la batidora 69386/69382**  
Suitable for blender 69386/69382



CRISTAL  
Glass

### Set 2 jarras de cristal

Set de 2 pichets en verre · 2er-Set Glasbehälter  
Set of 2 glass pitchers · Conjunto de 2 jarras de vidro

Ref	€	Capacidad	U.Venta
69387	19,60	500ml	1

**Jarra de vidrio templado (500 ml)**  
High quality toughened glass (500 ml)

**Incluye 4 pajitas desechables de papel ecológico**  
Includes 4 disposable straws made from eco-friendly paper



### Set 4 pajitas + cepillo

Plaque à induction a/regulateur · Induktionskochfeld m/ regler  
Round induction plate with power control · Placa de indução com regulador

	Ref	€	Color	Ø (cm)	Largo (cm)	U.Venta
A	63131	5,00	Inox	0,6	21,5	1
B	63133	3,10	Cristal	0,6	21,5	1



# Batidoras profesionales



Batir, picar y moler  
Blend, chop and grind



**Batidora profesional Black**  
Batteur professionnel · Profi-Mixer  
Professional blender · Batedor profissional

**Batidora profesional White**  
Batteur professionnel · Profi-Mixer  
Professional blender · Batedor profissional

Ref	€	W	Velocidad	Capacidad	Medidas	U. Venta
69195	498,90	1200	13300-38000 rpm	2L	28x26x52 cm	1

Ref	€	W	Velocidad	Capacidad	Medidas	U. Venta
69295	431,60	1200	13000-38000 rpm	1,5L	18x24x42 cm	1

## Accesorios

Apta para las batidoras 69195 y 69295  
Apt for blenders 69195 and 69295



Apta para las batidoras 69195 y 69295  
Apt for blenders 69195 and 69295



**Jarra batidora con cuchilas Black**  
Pot batteur avec lamestl · Krug mit Messer für Mixer  
Blender jug with blades · Jarra batedora com lâminas

**Jarra batidora con cuchilas White**  
Pot batteur avec lamestl · Krug mit Messer für Mixer  
Blender jug with blades · Jarra batedora com lâminas

Ref	€	Capacidad	U. Venta
R69195N	195,70	2L	1
R69195B	49,30	-	1 Tapa · Lid

Ref	€	Capacidad	U. Venta
R69295A	193,10	1,5L	1
R69295D	76,70	-	1 Tapa · Lid

· **Aísla y reduce el nivel de ruido un 80%. Apta para las batidoras 69195 y 69295.**  
· **NOTA: La carcasa solo es valida si las batidoras llevan la jarra baja (R69295A), NUNCA con la jarra alta (R69195N).**

· Isolates and reduces the noise level by 80%. Apt for blenders 69195 and 69295.  
· NOTE: The casing is only valid if the blender comes with a lower recipient (R69295A), NEVER for a higher recipient (R69195N).



PC  
Polycarbonate

**Carcasa aislante de ruido**  
Boîtier isolant du bruit · Geräuschdämpfendes Gehäuse  
Noise reducing enclosure · Carcaça isolante do ruído

Ref	€	Medidas	h(cm)	U. Venta
R69295B	250,80	25x30cm	46	1



**Posibilidad de encastrar.**  
**Dimensiones del agujero: 25,5 x 26,5 cm.**

Possibilité d'encastrer.  
Dimensions du trou : 25,5 x 26,5 cm.

Encastrable option.  
Dimensions of the hole: 25,5 x 26,5 cm.

# Batidoras con jarra



Sistema Patentado



**Doble rodamiento ·**  
Double ball bearing  
**Alarga la vida útil de las cuchillas**  
Extend the lifespan of the blades



**Eje central conjunto**  
Central assembly axis  
**Eje central cuchillas**  
Central blades axis  
**Eje central de las cuchillas descentrada respecto al eje central del conjunto.**  
**Crema vórtices irregulares, evita obstrucciones y genera cortes más profundos.**  
Creates uneven vortices, avoid blockages and make deeper cuts.



**Jarra de vidrio borosilicato con escala**  
(ml / cups / oz)  
Borosilicate glass pitcher (ml / cups / oz)



**Batidora Inox**  
Mélangeur · Mixer  
Blender · Batedor

**Batidora White**  
Mélangeur · Mixer  
Blender · Batedor

Ref	€	W	Velocidad	Capacidad	Medidas	U. Venta
69581	160,70	1000	11000 - 16500 rpm	1,5L	20,5x20x41,5 cm	1

Ref	€	W	Velocidad	Capacidad	Medidas	U. Venta
69587	82,20	700	14400 - 16000 rpm	1,5L	22x18x40 cm	1

**Batidora Vita**  
Mixer · Mixer  
Blender · Batedora

Ref	€	W	Velocidad	Capacidad	Medidas	U. Venta
69081	87,70	500	10000-12000 rpm	1,5L	21x23x40 cm	1





# Máquinas de vacío

INOX Professional use



- Máquina de envasadora vacío campana de uso profesional.
- Aumenta el tiempo de conservación de los alimentos crudos o cocinados.
- Envasado por mediación de un compresor de aire.
- Compresor con pistón, dispone de válvula de entrada y salida de aire.
- Panel de control muy intuitivo y sencillo de utilizar.
- Envasado de líquidos.
- Especial para marinados.
- Doble soldadura para garantizar la estanqueidad del sellado.
- Tapa amortiguada de policarbonato transparente.
- Altura interior útil: 11 cm.
- Largura del sellado: 29 cm. Anchura del sellado: 4 cm.

- Empty Packaging machine Bell for professional use.
- Increase the conservation time of raw or cooked food.
- Packaged by mediation of an air compressor.
- Piston compressor, has air inlet and output valve.
- Very intuitive and simple control panel.
- Liquid packaging.
- Special for marinados.
- Double welding to guarantee the sealing.
- Transparent polycarbonate damping lid.
- Useful interior height: 11 cm.
- Sealing length: 29 cm. Sealing width: 4 cm.

## Máquina de vacío campana Chef

Machine sous vide à cloche · Vakuümiergeräte  
Bell-shaped vacuum machine · Máquina de vacío tipo cámara

Ref	€	W	Presión	Caudal bomba	Medidas internas	Medidas	U.Venta
69116	1756,40	630	0,9 bar	83 L/min	35x30x5 cm (campana)	42x36x36,5 cm	1



- Máquina de envasadora vacío campana de uso profesional.
- Aumenta el tiempo de conservación de los alimentos crudos o cocinados.
- Sellado por compresor de aire de gran potencia.
- Panel de control digital.
- Incluye porta rollos en su interior.
- Sirve para bolsas gofradas de hasta 30 cm y rollos (incluido un rollo).
- Diseñado especialmente para productos secos, húmedos y líquidos.
- Incluye función solo de vacío.
- Largura del sellado: 30 cm. Anchura del sellado: 2,5 cm.
- Caudal bomba: 60 litros/minuto.

- Empty Packaging machine Bell for professional use.
- Increase the conservation time of raw or cooked food.
- Sealed by large -power air compressor.
- Digital Control Panel.
- Includes roll holder inside.
- It serves for enrolled bags up to 30 cm and rolls (including a roll).
- Designed especially for dry, wet and liquid products.
- Includes empty function.
- Sealing length: 30 cm. Sealing width: 2.5 cm.
- Pump flow: 60 liters/minute.

## Máquina de vacío campana Black

Machine sous vide à cloche · Vakuümiergeräte  
Bell-shaped vacuum machine · Máquina de vacío tipo cámara

Ref	€	W	Presión	Caudal bomba	Medidas internas	Medidas	U.Venta
69352	998,90	350	0,9 bar	60 L/min	30,5x32,2x8 cm (campana)	42x38x27 cm	1



## Máquina de vacío Profesional

Machine sous vide · Vakuümiergerät  
Vacuum pack machine · Máquina de vacío

	Ref	€	W	Presión	Caudal bomba	Largo sellado	Medidas	U.Venta
A	69530	552,20	700	0,9 Bar	16 L/min	31 cm	39x27,5x13 cm	1
B	69540	613,60	650	0,9 Bar	16 L/min	40 cm	49x26x12,5 cm	1

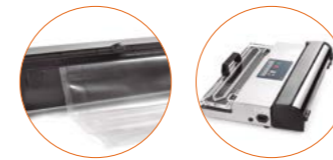

Compatible para bobinas hasta:  
Compatible for coils up to:  
69531 - 30 cm /  
69541 - 40 cm

## Soporte para rollo

Porte-rouleau · Rollenhalter  
Roll holder · Soporte de rolo

Ref	€	Largo (cm)	U.Venta
69531	25,20	30	1
69541	30,60	40	1



Barra para corte instantáneo  
Orificio para la aspiración de los botes  
Bar for instant cutting  
Opening for the sealing of canisters

3 niveles de tiempo de sellado (secos, húmedos...)  
Doble bomba de vacío  
Three levels of sealing time  
(dry, wet, etc.). Dual vacuum pump

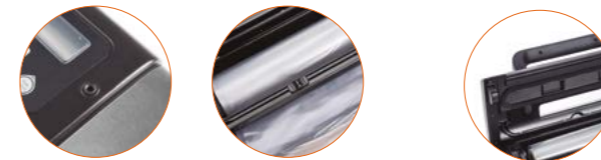

INOX

## Máquina de vacío Efficient

Machine sous vide · Vakuümiergerät  
Vacuum pack machine · Máquina de vacío

Ref	€	W	Presión	Caudal bomba	Largo sellado	Medidas	U.Venta
69353	229,60	130	0,9 Bar	20 L/min (2 bombas)	2 x 2 mm	40x20x11 cm	1

## Semiprofesional use

- Máquina de envasado al vacío profesional con carcasa externa de acero inoxidable, robusta e higiénica (libre de BPA).
- Ideal para preparar sous vide, marinar platos, almacenar distintos alimentos naturales o cocinados, etc.
- Aumenta la vida útil de los alimentos gracias al buen sellado hermético que proporciona la máquina.
- Garantiza sabor, valor nutricional, frescura y protección de los alimentos.
- Funcionamiento intuitivo y sencillo: envasado automático, función de sellado continuo, función marinado (muy útil para ahorrar tiempo frente a los marinados convencionales) y función cánister.
- Ahorra tiempo y dinero.
- Está equipada con una barra de sellado extra ancha de 5 mm.
- Doble bomba de vacío muy potente, garantiza un vacío óptimo.
- Gracias a su asa en la tapa el envasado al vacío es más cómodo.
- Se apoya en cuatro pies de goma para una mayor estabilidad.

- Ideal to prepare sous vide, marinate dishes, store different natural or cooked foods, etc.
- Increase the life of food thanks to the good hermetic sealing that the machine provides.
- It guarantees flavor, nutritional value, freshness and food protection.
- Intuitive and simple operation: automatic packaging, continuous sealing function, marinated function (very useful to save time against conventional marinates) and Canister function.
- Save time and money.
- It is equipped with an extra 5 mm wide sealed bar.
- Double very powerful vacuum pump, guarantees an optimal vacuum.
- Thanks to your handle on the lid, vacuum packaging is more comfortable.
- It relies on four feet of rubber for greater stability.

## Accesorios

Bobinade 28 cm x 5 m (incluida)  
Doble banda de sellado  
28 cm x 5 m coil tube (included)  
Wide double-band

**Incluye 10 bolsas de vacío (20x30 cm)**  
Includes 10 vacuum bags (20x30 cm)

**Función canister**  
Canister function



### Máquina de vacío Home

Machine sous vide · Vakuuiergerät  
Vacuum pack machine · Máquina de vacío

Ref	€	W	Presión	Caudal bomba	Largo sellado	Medidas	U.Venta
69050	<b>110,00</b>	110	0,8 bar	9 L/min	28 cm	35,5x15x9 cm	1

**Incluye 10 bolsas de vacío: 20x30 cm (5) / 28x40 cm (5)**  
Includes 10 vacuum bags: 20x30 cm (5) / 28x40 cm (5)

### Máquina de vacío Luxe

Machine sous vide · Vakuuiergerät  
Vacuum pack machine · Máquina de vacío

Ref	€	W	Presión	Caudal bomba	Largo sellado	Medidas	U.Venta
69151	<b>124,70</b>	120	0,4 - 0,8 bar	9 L/min	30 cm	37x14,5x7,5 cm	1



*AutoPlace*

**Garantiza la colocación correcta de la bolsa**  
Placement correct des sacs garanti · Ensures bags are inserted correctly



**Tapa totalmente extraíble**  
Totally removable lid

**Incluye accesorio para función canister**  
Accessory for canister function included

### Máquina de vacío Smart

Machine sous vide · Vakuuiergerät  
Vacuum pack machine · Máquina de vacío

Ref	€	W	Presión	Caudal bomba	Largo sellado	Medidas	U.Venta
69357	<b>105,60</b>	120	0,8 bar	5 L/min	30 cm	38x16x6 cm	1



*AutoPlace*

**Garantiza la colocación correcta de la bolsa**  
Placement correct des sacs garanti · Ensures bags are inserted correctly

### Máquina de vacío AutoPro

Machine sous vide · Vakuuiergerät  
Vacuum pack machine · Máquina de vacío

Ref	€	W	Presión	Caudal bomba	Largo sellado	Medidas	U.Venta
69356	<b>98,00</b>	120	0,8 bar	4,3 L/min	30 cm	37,8x17x5,8 cm	1



**Orificio para la aspiración de los botes**  
Opening for the sealing of canisters



### Máquina de vacío Slim

Machine sous vide · Vakuuiergerät  
Vacuum Upackmaschine · Máquina de vacío

Ref	€	W	Presión	Caudal bomba	Largo sellado	Medidas	U.Venta
69354	<b>81,50</b>	80	0,5 Bar	4 L/min	2 mm	38,4x9,7x5,7 cm	1



**Compartimento para líquidos**  
Compartment for liquids

**Incluye:**

**5 bolsas de 20x30cm / Bobina de 20cmx2m**  
**Tubo canister de 40 cm de largo**  
Includes: 5 20x30cm bags / 20cmx2m coil tube  
40 cm-long canister hose



### Máquina de vacío Extreme

Machine de conditionnement sous vide · Vakuuiergerät  
Vacuum machine · Máquina de vacío

Ref	€	W	Presión	Caudal bomba	Largo sellado	Medidas	U.Venta
69355	<b>148,50</b>	110	0,8 Bar	12 L/min	30 cm	42x9,5x15 cm	1



- Sella herméticamente los alimentos aumentando de 3 a 5 veces más tiempo su durabilidad. Expulsa el aire y la humedad, manteniendo sus sabores y nutrientes.
- Ideal para alimentos sólidos, carnes, pescados, embutidos, legumbres, verduras, tanto frescos como cocinados, alargando su conservación.
- 2 niveles de sellado: uno para alimentos húmedos y otro para alimentos secos.
- Compartimento para rollo de 28 cm x 3 m (incluido) con barra para corte instantáneo.
- Opción de vaciado manual; diseñado para obtener presión de vacío adecuada en el caso de alimentos frágiles (pescado, por ejemplo).
- Gracias a su asa integrada en la tapa el envasado al vacío será más cómodo.
- Carcasa externa de acero inoxidable, robusta e higiénica.
- Contiene orificio para la aspiración de los botes. Incluye adaptador para botes de vacío.

- Hermetically seals food, increasing its shelf life by 3 to 5 times. Expels air and moisture and retains flavours and nutrients. Ideal for solid food, meat, fish, sausages, pulses, vegetables, both fresh and cooked, extending their shelf life.
- 2 sealing levels: one for wet food and the other for dry food.
- Compartment for 28 cm x 3 m roll (included) with bar for instant cutting.
- Manual vacuum option: designed to ensure adequate vacuum pressure for fragile food (e.g. fish).
- Features an integrated handle on the lid to simplify the vacuum packaging process.
- Robust and hygienic stainless steel outer casing.
- Contains canister vacuuming hole. Includes canister vacuuming adapter.



**Barra para corte instantáneo**  
Instant cutter bar

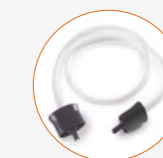

**Incluye adaptador para botes de vacío y bobina de 28 cm x 3 m**  
Includes adapter for canister and 28 cm x 3m roll

### Máquina de vacío Ingenious

Machine à vide Ingenious · Vakuumaschine Ingenious  
Vacuum machine Ingenious · Máquina de vacío Ingenious

Ref	€	W	Presión	Caudal bomba	Largo sellado	Medidas	U.Venta
69358	<b>146,40</b>	120	0,8 bar	12 L/min	28 cm	40x17,5x10 cm	1





# Bobinas, botes y bolsas de vacío

PE Polyethylene  
 *Professional use*

- Apto para uso alimenticio.
- Recomendada para uso con máquina de vacío de la marca LACOR.
- No se recomienda su reutilización tras el uso con carnes, pescados y otros alimentos deteriorables, tan solo tras el uso en productos secos, legumbres, frutos secos, etc.

- Adaptée au conditionnement de denrées alimentaires.
- Recommandée pour être utilisée avec la machine à emballer sous vide LACOR.
- Son utilisation est déconseillée pour reconditionner de la viande, du poisson et d'autres denrées Alimentaires périssables. Elle peut être réutilisée pour reconditionner des fruits secs, des légumes, des fruits secs, etc.

- Suitable for use with food.
- Recommended for use with vacuum Packer of the LACOR brand.
- Not recommended to be reused after use with meats, fish and other fresh foods, only after use with dried products, pulses, nuts, etc.



## Bobina tubo vacío

Bobine de tube · Vakuumbutel Rollen  
 Coil tube · Bobina manga

Ref	€	Micras	Bobina	U.Venta
69052	14,30	105	28cmx5m, 22cmx5m	1
69057	9,70	105	14cmx10m	6
69059	13,40	105	22cmx10m	1
69058	17,50	105	28cmx10m	1
69451	19,70	105	40cmx10m	1
69259	9,00	105	28cmx5m	1
69458	11,60	90	28cmx5m	1
69459	9,20	90	22cmx5m	6
69462	9,90	105	28cmx5m, 22cmx5m	1
69463	8,70	105	22cmx10m	1
69464	11,00	105	28cmx10m	1
69452	6,10	105	12cmx10m	6

## Bolsas de vacío

Sacs de conservation sous vide · Vakuumbutel, 100 Stueck  
 Vacuum bags · Sacos de vacío

Ref	€	Micras	Unidad	Medidas	U.Venta
69053	5,20	105	25	20 x 16 x 1,5 cm	6
69054	8,80	105	25	30 x 20 x 1,5 cm	6
69055	11,90	105	25	35 x 25 x 2 cm	1
69056	14,90	105	25	40 x 28 x 2 cm	1
69042	32,70	105	100	30 x 20 x 3 cm	1
69046	47,70	105	100	36 x 25 x 6 cm	1
69047	65,00	105	100	40 x 30 x 5 cm	1
69048	130,40	105	100	45 x 37 x 10 cm	1
69453	6,10	90	25	16 x 20 x 1,5 cm	6
69454	11,20	90	25	30 x 20 x 1,5 cm	1
69455	15,60	90	25	36,5 x 24 x 3 cm	1
69460	5,70	105	25	30 x 20 x 2 cm	1
69461	10,20	105	25	40 x 28 x 2 cm	1

## Set 3 botes vacío hogar + adaptador

3 boîte sous vide + Adaptateur · 3 Vakuumb-Behälter-Set + Adapter  
 3 Shape canister set + Adapter · Conj. 3 caixas vácuo domésticas + Adaptador

Ref	€	Capacidad	U.Venta
69051	37,30	0,7L/ 1,4L/ 2L	1



## Máquina de vacío / Vacuum Pack machine

Ref	69052	69057	69059	69058	69451	69259	69458	69459	69462	69463	69464	69053	69054	69055	69056	69042	69046	69047	69453	69454	69455	69460	69461	69048(*)	69452	69051	69116	69352	69530	69540	69353	69050	69151	69357	69356	69355	69354	
ROLLO - COIL TUBE	28cmx5m/22cmx5m	14cmx10m	22cmx10m	28cmx10m	40cmx10m	28cmx5m	28cmx5m	22cmx5m	28cmx5m/22cmx5m	22cmx10m	28cmx10m	Gofrada	Gofrada	Gofrada	Gofrada	Gofrada	Gofrada	Gofrada	Gofrada	Lisa	Lisa	Gofrada	Gofrada	Gofrada	Gofrada	Gofrada	Gofrada	Gofrada	Gofrada	Gofrada	Gofrada	Gofrada	Gofrada	Gofrada	Gofrada	Gofrada	Gofrada	
BOLSAS - BAGS	16x20	20x30	24x36	28x40	20x30	25x35	30x40	16x20	20x30	24x36	28x40	Gofrada	Gofrada	Gofrada	Gofrada	Gofrada	Gofrada	Gofrada	Gofrada	Lisa	Lisa	Gofrada	Gofrada	Gofrada	Gofrada	Gofrada	Gofrada	Gofrada	Gofrada	Gofrada	Gofrada	Gofrada	Gofrada	Gofrada	Gofrada	Gofrada	Gofrada	Gofrada
BOBINA EMBUTIDOS COIL TUBE FOR SAUSAGES	40x60	28x40	28x40	40x60	12cmx10m																																	
SET 3 BOTES VACIO 3 SHAPE CANISTER SET	0,7 - 1,4 2, 0 L																																					

(\*) Apta para la máquina de vacío 69040 (descatalogada)  
 ■ Bolsas y rollos para uso exclusivo del SOUS VIDE





# Colección Sous Vide



- Técnica culinaria que prima la calidad del producto.
- Resultados sorprendentes; alimentos más jugosos, tiernos y succulentos.
- Preserva las cualidades del producto y realiza su sabor y textura.

- Technique culinaire qui privilégie la qualité du produit.
- Résultats surprenants ; aliments plus juteux, tendres et succulents.
- Préserve les qualités du produit et améliore sa saveur et sa texture.

- Culinary technique that enhances the quality of the product.
- Amazing results; juicier, more tender and more succulent food.
- Preserves the qualities of the product and enhances its flavour and texture.

new



- Carcasa fabricada en acero inoxidable 18/10.
- Resistente, robusto y duradero, garantiza un rendimiento profesional.
- Diseñado para profesionales; especialmente para su uso en restaurantes, bares, hoteles, etc.
- Gran efectividad y máxima precisión: garantiza resultados excepcionales en cada plato.
- Control preciso de la temperatura: El caudal de la bomba de agua permite calentar recipientes de hasta 80 litros consiguiendo una temperatura uniforme en toda su área. Preservando así las cualidades del producto y realizando su sabor y textura.
- Interfaz intuitiva.
- Alarma de bajo nivel de agua y desconexión automática.
- Portátil, compacto y muy fácil de transportar.
- Pinza de sujeción apta para cualquier recipiente.
- Máxima impermeabilidad gracias a su sistema IPX7.

- Boîtier en acier inoxydable 18/10.
- Solide, robuste et durable, il garantit des performances professionnelles.
- Conçu pour les professionnels, notamment dans les restaurants, les bars, les hôtels, etc.
- Rendement élevé et précision maximale : garantis des résultats exceptionnels pour chaque plat.
- Contrôle précis de la température : le débit de la pompe à eau permet de chauffer des récipients jusqu'à 80 litres, en obtenant une température uniforme dans toute la zone. Cela permet de préserver les qualités du produit et d'en améliorer la saveur et la texture.
- Interface intuitive.
- Alarme de bas niveau d'eau et arrêt automatique.
- Portable, compact et très facile à transporter.
- Pince adaptée à tout type de récipient.
- Étanchéité maximale grâce au système IPX7.

- Housing made of 18/10 stainless steel.
- Strong, robust and durable, it guarantees professional performance.
- Designed for professionals; especially for use in restaurants, bars, hotels, etc.
- High efficiency and maximum precision: guarantees exceptional results in every dish.
- Precise temperature control: The flow rate of the water pump makes it possible to heat containers of up to 80 litres, achieving a uniform temperature throughout the entire area. This preserves the qualities of the product and enhances its flavour and texture.
- Intuitive interface.
- Low water level alarm and automatic shut-off.
- Portable, compact and easy to transport.
- Clamp suitable for any container.
- Maximum waterproofness thanks to its IPX7 system.



Protection Against Temporary immersion

## Professional use

### Sous Vide Master

Sous Vide · Sous Vide  
Sous Vide · Sous Vide

Ref	€	W	Caudal bomba	Temperatura	Capacidad	Tiempo	U.Venta
69592	526,20	2300	10 L/min	5°C-95°C	80L	99	1



Protection Against Temporary immersion

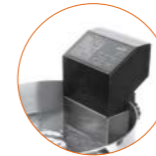

## Professional use

### Sous vide Pro

Sous Vide · Sous Vide  
Sous Vide · Sous Vide

Ref	€	W	Caudal bomba	Temperatura	Presión	Capacidad	Tiempo	U.Venta
69192	474,10	1500	6 L/min	5-99°C	0,1°C	40L	0-99 h	1



Protection Against Temporary immersion



## Semiprofessional use

### Sous vide Precise

Sous Vide · Sous Vide  
Sous Vide · Sous Vide

Ref	€	W	Caudal bomba	Temperatura	Presión	Capacidad	Tiempo	U.Venta
69304	315,20	1200	4,5 L/min	5-99°C	0,1°C	30L	Hasta 99 horas	1



Protection Against Temporary immersion



## Household use

### Sous vide Gourmet

Sous Vide · Sous Vide  
Sous Vide · Sous Vide

Ref	€	W	Temperatura	Presión	Capacidad	Tiempo	U.Venta
A 69302	208,30	1200	20-90°C	1°C	15L	99 h	1
B 69303	208,30	1200	20-90°C	1°C	15L	99 h	1





## Professional use

- Cocina alimentos envasados al vacío a baja temperatura.
- Alimentos más tiernos, sabrosos y con la mejor textura.
- Resultados de alta calidad.
- Carcasa robusta fabricada íntegramente en acero inoxidable.
- Cierre hermético gracias a la tapa con borde de silicona.
- Incluye rejilla divisoria para la separación de las bolsas.
- Pantalla digital de tiempo y temperatura.
- Termostato de gran precisión ajustable: 30°C - 90°C (0,1 °C).
- Temporizador ajustable: 99 horas. 6 memorias. Capacidad: 17 litros.
- Filtro de seguridad para evitar impurezas en el sistema de recirculación del agua.
- Incorpora grifo de vaciado.

- Cuire les aliments emballés à basse température.
- Aliments plus fastils et savoureux et avec la meilleure texture.
- Résultats de haute qualité.
- Logement robuste fabriqué entièrement en acier inoxydable.
- Clôture hermétique grâce au couvercle de bord en silicone.
- Comprend la division de la grille pour la séparation des sacs.
- Écran numérique du temps et de la température.
- Thermostat d'une grande précision réglable: 30 ° C - 90 ° C (0,1 ° C).
- Minuterie réglable: 99 heures. 6 souvenirs. Capacité: 17 litres.
- Filtre de sécurité pour éviter les impuretés dans le système de recirculation de l'eau.
- Intègre le robinet de vidange.

- Cooking food packaged at low temperature.
- Easier, tasty foods and with the best texture.
- High quality results.
- Robust housing manufactured entirely in stainless steel.
- Hermetic closure thanks to the silicone edge lid.
- Includes dividing grid for the separation of the bags.
- Time and temperature digital screen.
- Thermostat of great adjustable precision: 30°C - 90 ° C (0.1 ° C).
- Adjustable timer: 99 hours. 6 memories. Capacity: 17 liters.
- Security filter to avoid impurities in the water recirculation system.
- Incorporates emptying tap.

### Cocedor Sous vide

Cuiseur Sous Vide · Sous-Vide-Kochapparat  
Sous Vide cooker · Máquina de cozinhar a vácuo Sous Vide

Ref	€	W	Caudal bomba	Temperatura	Presión	Capacidad	Tiempo	Medidas	U.Venta
69492	729,70	1600	4L/min	30-95°C	0,1°C	17L	0-99h	62,5x36x30 cm	1



## Semiprofessional use

- Técnica culinaria que prima la calidad del producto.
- Diseñado para uso semi profesional. Tamaño compacto.
- Fabricada en acero inoxidable de gran calidad.
- Resultados sorprendentes; alimentos más jugosos, tiernos y succulentos.
- Preserva las cualidades del producto y realza su sabor y textura.
- Panel de control táctil súper intuitivo.

- Culinary technique that puts the quality of the product first.
- Designed for semi-professional use, compact size.
- Made of high quality stainless steel.
- Surprising results; juicier, more tender and succulent food.
- Preserves the qualities of the product and enhances its flavour and texture.



### Sous vide con tapa

Sous Vide avec couvercle · Sous Vide mit Deckel  
Sous Vide with lid · Sous Vide com tampa

Ref	€	W	Caudal bomba	Temperatura	Presión	Capacidad	Tiempo	Medidas	U.Venta
69193	748,60	620	6 L/min	5-99°C	0,1°C	12,5L	0-99 h	27 x 29 x 42 cm	1

# Accesorios Sous Vide

## Professional use



PP  
Polypropylene



### Bolsas aislantes para sous vide

Billes isolantes p/appareils de conditionnement Sous-Vide · Isolationskugeln  
Sous Vide Insulation Balls · Esferas isolantes para Sous Vide

Ref	€	Ø (cm)	Unidad	U.Venta
69219	29,00	2,0	100	1

- Bolas aislantes huecas y flotantes de polipropileno (PP), libres de BPA, para dispositivos sous-vide.
- Crean una capa de aislamiento evitando la pérdida de calor en un 75% y en un 90% la evaporación del agua.
- Permiten hervir agua durante horas sin tener que echar más, gracias al mínimo contacto entre agua y aire.
- Aumentan la precisión de la temperatura y ayudan a mantener los envasados al vacío bajo el agua.
- Reducen humos y riesgos de salpicaduras.
- Soportan hasta 150°C sin ningún problema.
- Compatibles con recipientes de todas las formas y tamaños.
- Se presenta con una práctica malla con cierre de cordón.

- Hollow and floating insulating balls of polypropylene (PP), BPA free, for sous-vide devices.
- They create an insulation layer avoiding heat loss by 75% and at 90% the evaporation of water.
- They allow boiling water for hours without having to throw more, thanks to the minimum contact between water and air.
- They increase temperature precision and help keep vacuum underwater.
- They reduce smoke and splashes risks.
- They support up to 150°C without any problem.
- Compatible with containers of all shapes and sizes.
- It is presented with a practice mesh with cord closure.



Perfecta capa de aislamiento  
Perfect insulation layer

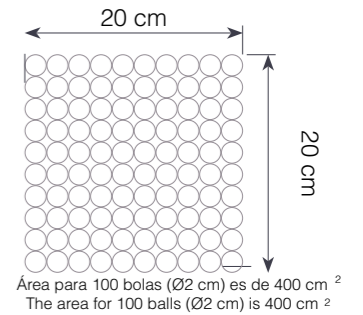

- Su diseño es ideal para la sujeción en vertical de 4 bolsas de vacío.
- Evita que las bolsas floten y entren en contacto con las paredes o fondo de las cubetas.
- Permite la circulación del agua entre las bolsas en todo momento, consiguiendo una cocción uniforme.
- Agiliza introducir y retirar las bolsas con facilidad.

- Sa conception est idéale pour le support vertical de 4 sacs à vide.
- Il empêche les sacs de farine et entrez en contact avec les murs ou le fond des seaux.
- Il permet à tout moment la circulation de l'eau entre les sacs, en réalisant une cuisson uniforme.
- La dalle introduit et retirez facilement les sacs.

- Its design is ideal for vertical support of 4 vacuum bags.
- It prevents the bags from flour and come into contact with the walls or background of the buckets.
- It allows the circulation of water between the bags at all times, achieving a uniform cooking.
- Slabe introduce and remove the bags easily.



INOX  
18/10

### Rejilla Sous vide

Rack pour Sous Vide · Rack für Sous Vide  
Rack for sous vide · Cremalheira para sous Vide

Ref	€	Diámetro varilla (mm)	Medidas	U.Venta
67051	16,50	4	20x13,5x13,5 cm	1





## Armarios refrigeradores Black

AL Aluminium   *Semiprofessional use*

- Diseñado para refrigerar eficazmente botellas de vino y otras bebidas.
  - La temperatura interior puede ser ajustada mediante el control electrónico.
  - Puerta con cámara de cristal templado y sistema de apertura con tirador.
  - Estantes extraíbles.
  - Silencioso y sistema antivibratorio.
  - Pies regulables en altura.
  - **NOTA: deje suficiente espacio en la parte trasera (mínimo 5 cm) para permitir la salida del calor y una adecuada ventilación.**
  - Vinoteca termoeléctrica: el control y regulación de la temperatura dependerá de la temperatura ambiental del establecimiento.
- Conçu pour réfrigérer efficacement les bouteilles de vin et autres boissons.
  - La température intérieure peut être ajustée par contrôle électronique.
  - Porte avec chambre de verre trempée et système d'ouverture avec un tireur.
  - Étagères amovibles.
  - Système silencieux et antivibratoire.
  - Hauteur - Pieds ajustés.
  - Remarque: laissez suffisamment d'espace à l'arrière (minimum 5 cm) pour permettre la sortie de chaleur et une ventilation adéquate.
  - Bibliothèque de vin thermoélectrique: le contrôle et la régulation de la température dépendra de la température ambiante de l'établissement.
- Designed to effectively refrigerate wine bottles and other drinks.
  - The interior temperature can be adjusted by electronic control.
  - Door with temperate glass chamber and opening system with a shooter.
  - Removable shelves.
  - Silent and antivibratory system.
  - Height -adjustable feet.
  - Note: Leave enough space in the back (minimum 5 cm) to allow heat outlet and adequate ventilation.
  - Thermoelectric wine library: The control and regulation of temperature will depend on the ambient temperature of the establishment.

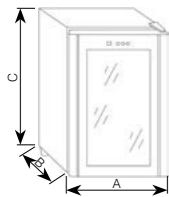

### Armarios refrigeradores Black

Refridisseur à vin · Thermo Weinkühler  
Thermo wine cooler · Armário refrigerador

	Ref	€	W	Botellas	Temperatura	Consumo (g/h)	Medidas	U.Venta
<b>A</b>	69670	396,10	70	8	1-18°C	190 kWh/annum	26x49,5x48 cm	1
<b>B</b>	69671	425,20	70	12	1-18°C	129 kWh/annum	34,5x48x47 cm	1
<b>C</b>	69672	472,00	70	18	1-18°C	146 kWh/annum	34,5x48x67 cm	1
<b>D</b>	69673	530,40	70	28	1-18°C	179 kWh/annum	45x52x72,5 cm	1



## Armarios con compresor Merlot

AL Aluminium   *Semiprofessional use*

- **Armario refrigerador con sistema de enfriamiento por compresor.**
  - Diseñado para refrigerar eficazmente botellas de vino y otras bebidas.
  - La temperatura interior puede ser ajustada mediante el control electrónico.
  - Acabado en acero inoxidable y cristal negro.
  - Puerta con cámara de cristal templado y sistema de apertura con tirador.
  - Estantes extraíbles acabados en madera.
  - Silencioso y sistema antivibratorio.
  - Pies regulables en altura.
  - **NOTA: deje suficiente espacio en la parte trasera (mínimo 5 cm) para permitir la salida del calor y una adecuada ventilación.**
- Armoire au réfrigérateur avec système de refroidissement du compresseur.
  - Conçu pour réfrigérer efficacement les bouteilles de vin et autres boissons.
  - La température intérieure peut être ajustée par contrôle électronique.
  - Finition en acier inoxydable et verre noir.
  - Porte avec chambre de verre trempée et système d'ouverture avec un tireur.
  - Étagères amovibles en bois.
  - Système silencieux et antivibratoire.
  - Hauteur - Pieds ajustés.
  - Remarque: laissez suffisamment d'espace à l'arrière (minimum 5 cm) pour permettre la sortie de chaleur et une ventilation adéquate.
- Refrigerator wardrobe with compressor cooling system.
  - Designed to effectively refrigerate wine bottles and other drinks.
  - The interior temperature can be adjusted by electronic control.
  - Stainless steel finish and black glass.
  - Door with temperate glass chamber and opening system with a shooter.
  - Removable shelves in wood.
  - Silent and antivibratory system.
  - Height -adjustable feet.
  - Note: Leave enough space in the back (minimum 5 cm) to allow heat outlet and adequate ventilation.



### Armarios con compresor Merlot

Refridisseur à vin à compresseur · Weinkühler mit Kompressor  
Compressor type wine cooler · Refrigerador de vinho do tipo compresso

	Ref	€	W	Botellas	Temperatura	Consumo (g/h)	Ruido	Refrigerante	Medidas	U.Venta
<b>A</b>	69700	537,80	85	12	5-18°C	107 kWh/año	45 dB	R600a	44x47x53 cm	1
<b>B</b>	69701	553,50	85	12	5-18°C	136 kWh/año	45 dB	R600a	25x45x79 cm	1
<b>C</b>	69702	828,50	85	18	5-18°C	145 kWh/año	46 dB	R600a	34,5x48x83 cm	1
<b>D</b>	69239	452,50	85	18	5-18°C	120 kWh/año	42 dB	R600a	34,5 x 45 x 77,5 cm	1
<b>E</b>	69238	482,50	85	28	5-18°C	189 kWh/año	42 dB	R600a	43,2 x 45 x 84,5 cm	1
<b>F</b>	69703	863,10	85	51	5-18°C	156 kWh/annum	47 dB	R600a	49,5x56,5x85 cm	1

\* **Dispone de doble cámara con temperaturas independientes (ref.69702).**  
It has a double chamber with independent temperatures (ref. 69702).



# Sacacorchos



- Diseño elegante, moderno y ergonómico: ideal para su uso profesional y de hogar.
- Funcionamiento rápido y sencillo tan solo pulsando un botón.
- Facilita la extracción del corcho de cualquier botella de vino en tan solo 6-8 segundos.
- Extrae el corcho suavemente y de forma silenciosa.
- Cabezal de extracción con iluminación led.
- Indicador de batería luminoso mediante LED: 4 niveles para indicar el nivel de energía.
- Se carga mediante cable Micro USB.
- Incluye: cable cargador USB y descapsulador.



Autonomía  
Battery life  
**30-40**  
Botellas  
Bottles



## Sacacorchos Black Luxe

Tire-bouchon · Korkenzieher  
Corkscrew · Saca-rolhas

Ref	€	Ø (cm)	h(cm)	U.Venta
63056	39,30	4,8	22	1



Autonomía  
Battery life  
**30**  
Botellas  
Bottles



## Sacacorchos eléctrico AutoPro

Tire bouchon électrique · Korkenzieher, elektrisch  
Electric corkscrew · Saca-rolhas Eléctrico

Ref	€	cm	U.Venta
63031	41,80	Ø12x32	1



- Design élégant, moderne et ergonomique: idéal pour un usage professionnel et à domicile.
- Fonctionnement rapide et simple simplement en appuyant sur un bouton.
- Il facilite l'extraction du bouchon de n'importe quelle bouteille de vin en seulement 6 à 8 secondes.
- Extraire le liège doucement et silencieusement.
- Tête d'extraction avec éclairage LED.
- Indicateur de batterie LED Utilisation de LED: 4 niveaux pour indiquer le niveau d'énergie.
- Il est chargé par un câble micro USB.
- Comprend: câble de chargeur USB et décapsuleur.



Autonomía  
Battery life  
**30-40**  
Botellas  
Bottles



## Sacacorchos Black

Tire-bouchon · Korkenzieher  
Corkscrew · Saca-rolhas

Ref	€	Ø (cm)	h(cm)	U.Venta
63057	30,40	5	19	1



Autonomía  
Battery life  
**30-40**  
Botellas  
Bottles



## Sacacorchos eléctrico Smart

Tire bouchon électrique · Korkenzieher, elektrisch  
Electric corkscrew · Saca-rolhas Eléctrico

Ref	€	cm	U.Venta
63054	44,90	Ø5x25	1



# Refrigeradores Bar



## Mini bar Vista

Mini frigo bar · Minibar Kühlschrank  
Mini-bar refrigerator · Refrigerador mini-bar

Ref	€	W	Capacidad	Temperatura	Consumo	Ruido	Medidas	U.Venta
69675	258,40	70	36L	11°C-18°C	176 kWh/año (year)	26 dB	43x41x51 cm	1



Puerta reversible  
Reversible door

- Diseñado para hoteles, bares, campings y ocinas.
- Funcionamiento termoeléctrico, ideal para refrigerar y mantener cualquier bebida o alimento fresco.
- Totalmente silencioso.
- Puerta reversible de cristal templado transparente con cierre hermético.
- Capacidad de 36 litros.
- Termostato regulador de temperatura para asegurar que los productos se mantienen frescos y en perfectas condiciones.
- Iluminación interna mediante LED.
- Incluye una bandeja interna.
- Descongelación automática inteligente, evita la acumulación de hielo en el interior del minibar.
- Specially designed for hotels, bars, ofices and camping.
- Thermoelectric operation: ideal for refrigerating food or drinks and keeping them cool.
- Totally silent.
- Reversible door made of transparent, hermetically sealed tempered glass.
- Capacity: 36 L.
- Temperature controlling thermostat to keep all items fresh and in perfect condition.
- Internal LED lighting.
- Comes with 1 inner rack.
- Smart auto defrost technology to prevent ice from building up inside.

A



B



Puerta reversible  
Reversible door

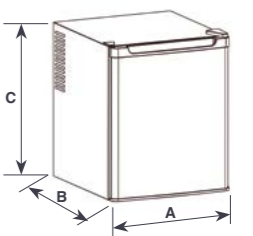

No introduzca alimentos o bebidas calientes  
Do not introduce hot food or drinks

## Mini bar

Mini frigo bar · Minibar Kühlschrank  
Mini-bar refrigerator · Refrigerador mini-bar

Ref	€	W	Capacidad	Niveles temperatura	Consumo (g/h)	Ruido	Refrigerante	Medidas AxBxC	U.Venta
A 69070	263,90	70	40L	3	197 kWh/annum	39 dB (máx)	R600a (27g)	43 x 41 x 51 cm	1
B 69075	263,90	70	40L	3	197 kWh/annum	39 dB (máx)	R600a (27g)	43 x 41 x 51 cm	1

REFRIGERADOR TERMOELÉCTRICO: el control y regulación de la temperatura, dependerá de la temperatura ambiental del establecimiento  
THERMOELECTRIC REFRIGERATOR: temperature control and regulation depend on the ambient temperature of the establishment

# Máquinas de hielo

INOX     Professional use

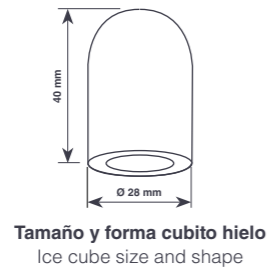
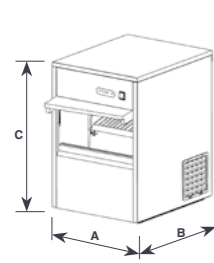

Tamaño y forma cubito hielo  
Ice cube size and shape



## Máquina de hielo Pro

Machine à fabriquer des glaçons · Eiswürfelmaschine  
Ice maker · Máquina de hielo

Ref	€	W	Capacidad hielo	Producción	Medidas AxBxC	U.Venta
69320	1099,20	170	4kg	>20kg/24h	38x48x59 cm	1

En 10 o 12 minutos, obtendrá cubitos de hielo. Dispone de programador  
In 10 to 12 minutes you will have ice cubes. It has a programmer



## Máquina de hielo Ice

Machine à glaçons · Eiswürfelmaschine  
Ice cubes maker · Máquina de fazer gelo

Ref	€	W	Capacidad contenedor	Capacidad hielo	Producción	Medidas	U.Venta
69314	424,60	150	1,5L	600 g	10-15kg/24h	32x32x28 cm	1

9 cubitos por ciclo (cada ciclo es de 8 min aproximadamente)  
9 cubes per cycle (each cycle is approximately 8 min.)

Tamaño y forma cubito hielo  
Ice cube size and shape

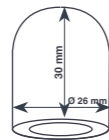

ABS PP  
Plastic Polypropylene

## Máquina de hielo Nord

Machine à glaçons · Eiswürfelmaschine  
Ice cubes maker · Máquina de fazer gelo

Ref	€	W	Capacidad contenedor	Capacidad hielo	Producción	Medidas	U.Venta
69340	277,50	100	2,2L	700g	12kg/24h	36x24x33 cm	1



# Picadoras de hielo

INOX 18/10    Semiprofessional use



Micro-interruptor de seguridad  
Safety micro-switch

## Picadora de hielo Ice

Broyeur à glaçons · Eis-Crusher  
Ice crusher · Picadora de gelo

Ref	€	W	Capacidad	Velocidad	Producción	Medidas	U.Venta
69431	510,50	200W	3 L	1000 r.p.m	90 kg/h	33x18,5x53 cm	1



## Picadora de hielo Pro

Broyeur à glace · Eis-Crusher  
Ice crusher · Picadora de gelo

Ref	€	W	Capacidad	Flujo de masa (Kg/h)	Embudo	Medidas	U.Venta
69313	116,70	60 - 80	2,8L	12 kg/h	Ø14 cm	17x29x47,5 cm	1



Embudo de llenado extraíble  
Removable cone



## Picadora de hielo Marble

Broyeur à glaçons · Eis-Crusher  
Ice crusher · Picadora de gelo

Ref	€	W	Capacidad	Medidas	U.Venta
69310	88,20	100	0,5 L	18x20,5x46,5 cm	1



# Máquina enfríacopas Freeze

INOX   Professional use

- Gracias a su diseño, la FREEZE es perfecta para cualquier local ya que se adapta a todo tipo de superficies, ocupando el mínimo espacio.
- Se puede ubicar donde se precise según las necesidades de cada ocasión.
- Perfecta para negocios de mucha actividad.
- Fabricado en acero inoxidable.
- Conexión a botella de CO2 de 28 ó 36 kg.
- Contador de operaciones.
- Luces tipo LED de activación por impulsos de gas.
- Sistema de conexión a botella con sistema de seguridad incluido.

- Grâce à sa conception, Freeze est parfait pour n'importe quel endroit car il s'adapte à tous les types de surfaces, occupant l'espace minimum.
- Il peut être localisé là où il est nécessaire en fonction des besoins de chaque occasion.
- Parfait pour beaucoup d'activité.
- En acier inoxydable.
- Connexion en bouteille de CO2 de 28 ou 36 kg.
- Compteur d'opérations.
- Lumières LED de l'activation de l'impulsion du gaz.
- Système de connexion à la bouteille avec système de sécurité inclus.

- Thanks to its design, Freeze is perfect for any place since it adapts to all types of surfaces, occupying the minimum space.
- It can be located where it is required according to the needs of each occasion.
- Perfect for a lot of activity.
- Made of stainless steel.
- CO2 bottle connection of 28 or 36 kg.
- Operations counter.
- LED lights of gas impulse activation.
- Bottle connection system with security system included.

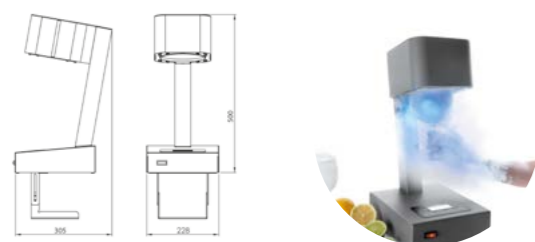

Precios NO sujetos al sistema de descuentos habitual de LACOR  
Prix non soumis au système habituel de remises de LACOR  
Prices not subject to the usual discount system of LACOR

## Máquina enfríacopas Freeze

Machine à givrer les verres · Gläser-Kühlmaschine  
Glass cooler machine · Máquina para enfriar copas

Ref	€	W	Programas	Medidas	U.Venta
69300	3241,20	25	4	23x31x50 cm	1

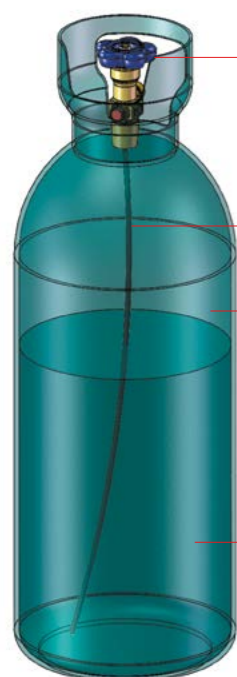

### ¿Qué tipo de gas utilizamos?

El gas que utilizan nuestras máquinas es Gas carbónico alimentario en estado líquido. El Dióxido de Carbono, también denominado óxido de carbono (IV), gas carbónico y anhídrido carbónico, CO<sub>2</sub>, es insípido, incoloro, inodoro y no inflamable.

Aunque la forma más común en que se encuentra el CO<sub>2</sub> es en estado gaseoso, bajo determinadas condiciones se puede encontrar también en estado líquido o sólido. Estas botellas están destinadas para uso médico y alimentario y lo que las diferencia del resto es que en su interior cuenta con una sonda que extrae el líquido criogénico que al liberarse alcanza una temperatura de -79,8 C°

### Seguridad LACOR

- 1.- Funcionamiento a base de gas carbónico líquido alimentario
- 2.- Control de presión de gas. Control de temperatura de congelación del gas ajustable de -8 a -55°C
- 3.- Fabricado en Acero Inoxidable de uso médico y alimentario. Todos los conductos interiores están fabricados en AISI-316 garantizando las óptimas condiciones alimentarias e higiénico-sanitarias
- 4.- Adaptable a cualquier tamaño de copa o vaso
- 5.- Exclusivo sistema de seguridad patentado y control para presiones superiores a 100 bar

### Nuestros artículos cumplen las siguientes normativas:

- 1.- Directiva 2006/95/CE de seguridad eléctrica
- 2.- Directiva 2006/108/CE de compatibilidad electromagnética
- 3.- Directiva 2006/42/CE de máquinas
- 4.- Norma UNE-EN ISO 12100-1:2004
- 5.- Norma UNE-EN ISO 12100-2:2004
- 6.- Norma EN 614-1:1996
- 7.- Norma UNE-EN ISO 13850:2007
- 8.- Norma UNE-EN 60335-1

### What type of gas do we use?

Our machines use liquid food grade Carbon dioxide gas. Carbon Dioxide, also called carbon oxide (IV), carbonic gas and carbon anhydride, CO<sub>2</sub>, is insipid, colourless, odourless and not flammable.

Although the most common state of CO<sub>2</sub> is gaseous, under certain conditions it can also be found in liquid or solid state. These bottles are used for medical and food uses and they are different from the rest in that their interiors have a probe that extracts the cryogenic liquid which when freed reaches temperatures of -79.8 °C

### LACOR Safety

- 1.- Operability based on liquid food grade carbon dioxide gas
- 2.- Control of gas pressure. Control of freezing temperature of the gas adjustable from -8 to -55 °C
- 3.- Manufactured from Stainless Steel for medical and food use. All the internal conducts are manufactured from AISI-316 guaranteeing optimal food and hygienic-health condition
- 4.- Adaptable to any size of glass
- 5.- Exclusive patented safety system and control for pressures above 100 bar

### Our articles fulfill the following standards:

- 1.- Directive 2006/95/CE for electrical safety
- 2.- Directive 2004/108/EC for electromagnetic compatibility
- 3.- Directive 2006/42/CE for machinery
- 4.- UNE-EN ISO 12100-1:2004 Standard
- 5.- UNE-EN ISO 12100-2:2004 Standard
- 6.- EN 614-1:1996 Standard
- 7.- UNE-EN ISO 13850:2007 Standard
- 8.- UNE-EN 60335-1 Standard

# Básculas profesionales

INOX   Professional use



## Báscula industrial con base

Balance industrielle avec base · Industrieller Küchenwaage mit Sockel  
Industrial scale with base · Balança industrial com base

Ref	€	Tara	Medidas	Peso (g)	U.Venta
61700	1178,00	150kg (20g)	49 x 75 x 90 cm	45kg	1

- Batería interna recargable (autonomía de 15 días).
- Visor de nivel, planitud.
- Avisador acústico de sobrecarga.
- Teclado intuitivo y de fácil uso. Funciones de calculadora.
- Acumulación de importes.
- Unidades de medida (Kg · oz · Libras). Función de tara.
- Libro de instrucciones en 7 idiomas.

- Batterie interne rechargeable (autonomie 15 jours).
- Indicateur de niveau, de planéité.
- Avertisseur acoustique de surcharge.
- Clavier intuitif d'utilisation facile. Fonctions de calculatrice.
- Accumulation de sommes
- Unités de mesure: (Kg · Oz · Livres). Fonction de tare
- Mode d'emploi en 7 langues

- Rechargeable internal battery (last 15 days).
- Level and fatness indicator.
- Overload alarm.
- Intelligent and easy-to-use keyboard. Calculator functions. Total counter.
- Measurement units: (Kg · Oz · pounds). Tare function
- Instructions book in 7 languages.



## Báscula profesional electrónica

Balance électronique professionnelle · Elektronische Profi-Waagen  
Electronic professional scale · Balança eletrónica profissional

Ref	€	W	Tara	IP	Peso (Kg)	U.Venta
61716	485,10	0,2 W	15kg/5g	IPX 54	4,60kg	1
61730	522,00	0,2 W	30kg/10g	IPX 54	4,60 kg	1

- Batería interna recargable (autonomía de 15 días).
- Visor de nivel, planitud.
- Avisador acústico de sobrecarga.
- Teclado intuitivo y de fácil uso. Funciones de calculadora.
- Acumulación de importes.
- Unidades de medida (Kg · oz · Libras). Función de tara.
- Libro de instrucciones en 7 idiomas.

- Batterie interne rechargeable (autonomie 15 jours).
- Indicateur de niveau, de planéité.
- Avertisseur acoustique de surcharge.
- Clavier intuitif d'utilisation facile. Fonctions de calculatrice.
- Accumulation de sommes
- Unités de mesure: (Kg · Oz · Livres). Fonction de tare
- Mode d'emploi en 7 langues

- Rechargeable internal battery (last 15 days).
- Level and fatness indicator.
- Overload alarm.
- Intelligent and easy-to-use keyboard. Calculator functions. Total counter.
- Measurement units: (Kg · Oz · pounds). Tare function
- Instructions book in 7 languages.

# Pizarra eléctrica



- **Llamativo sistema de promoción. Gran impacto visual.**
  - **Ideal para cualquier tipo de establecimiento: restaurantes, cafeterías, pubs, tiendas de alimentación, etc.**
  - **Diseñadas para colocarlas tanto vertical como horizontalmente gracias a la cadena suministrada**
  - **Uso similar de las pizarras normales, se escribe sobre la superficie (cristal templado) con rotuladores fluorescentes (Ref.:39161) y se borra con una simple bayeta de fibra.**
  - **Realice el dibujo en la pizarra totalmente desenchufada.**
- Système de promotion accrocheur. Grand impact visuel.
  - Idéal pour tout type d'établissement : restaurants, cafés, pubs, magasins d'alimentation, etc.
  - Conçu pour être placé aussi bien à la verticale qu'à l'horizontale, grâce à la chaîne fournie.
  - Semblables à des tableaux normaux, ils permettent d'écrire sur la surface (verre trempé) avec des marqueurs fluorescents (Ref.:39161) et essuyés avec un simple chiffon en fibre.
  - Dessinez sur le tableau complètement débranché.
- Eye-catching promotion system. Great visual impact.
  - Ideal for any type of establishment: restaurants, cafés, pubs, food shops, etc.
  - Designed to be placed both vertically and horizontally, thanks to the supplied chain.
  - Similar to normal blackboards, they are used for writing on the surface (tempered glass) with fluorescent markers (Ref.:39161) and wiped off with a simple fibre cloth.
  - Draw on the blackboard completely unplugged.



**Pizarra Led**  
Tableau lumineux à LED · LED Tafel  
Blackboard LED · Ardósia LED

Ref	€	W	Funciones	Medidas	U.Venta
A 39140	105,50	2	38	40x60 cm	1
B 39160	144,80	2	38	60x80	1

## Rotuladores fluorescentes 8 colores

Marqueurs fluorescents 8 couleurs · 8-Farben fluoreszierenden marker  
Fluorescent markers 8 colors · Maracadores fluorescentes 8 cores

Ref	€	cm	U.Venta
39161	34,10	10	1



# Afiladores eléctricos



- **Permite mantener los utensilios en perfecto estado.**
  - **Diseño elegante, acabado metalizado.**
  - **Dispone de diferentes ranuras para poder afilar distintos tipos de utensilios como cuchillos, tijeras o destornilladores de punta plana.**
  - **El motor gira a la velocidad óptima para que el afilado de los utensilios sea preciso y duradero.**
  - **100% seguro: en su base se incluyen cuatro ventosas de fijación para evitar que el afilador se mueva durante su uso.**
- Vous permet de garder les ustensiles en parfait état.
  - Design élégant, finition métallique.
  - Il a des rainures différentes pour pouvoir affiner différents types d'ustensiles tels que des couteaux, des ciseaux ou des tournevis sur la pointe plate.
  - Le moteur tourne à la vitesse optimale de sorte que l'affûtage des ustensiles est précis et durable.
  - 100% sûr: quatre tasses de ventouses à fixation sont incluses pour empêcher le hauteur de se déplacer pendant l'utilisation.
- Allows you to keep utensils in perfect condition.
  - Elegant design, metallic finish.
  - It has different grooves to be able to sharpen different types of utensils such as knives, scissors or screwdrivers on the flat tip.
  - The engine revolves at the optimal speed so that the sharpening of the utensils is precise and lasting.
  - 100% safe: four fixing suction cups are included to prevent the sharpener from moving during use.



## Afilador de cuchillos Rond

Affûteuse de couteaux électrique · Elektrische Schärmaschine  
Electric knife sharpener · Afiador de facas electrónico

Ref	€	W	Medidas	U.Venta
69141	33,00	60	14x14x10 cm	1

- Fase 1:**  
Alta abrasividad · High abrasiveness
- Fase 2:**  
Afilado fino · Thin sharp
- Fase 3:**  
Microafilado · Micro-sharp



## Afilador de cuchillos Pro

Affûteuse de couteaux électrique · Elektrische Schärmaschine  
Electric knife sharpener · Afiador de facas electrónico

Ref	€	W	Medidas	U.Venta
69261	127,60	180	32x12x11 cm	1



## Afilador de cuchillos TitanPro

Affûteuse de couteaux électrique · Elektrische Schärmaschine  
Electric knife sharpener · Afiador de facas electrónico

Ref	€	W	Medidas	U.Venta
69341	40,20	60	17x8x10 cm	1



## Afilador de cuchillos Mouse

Affûteuse de couteaux électrique · Elektrische Schärmaschine  
Electric knife sharpener · Afiador de facas electrónico

Ref	€	W	Medidas	U.Venta
60359	50,40	180	16x10x7 cm	1



## Afilador de cuchillos Drei

Affûteuse de couteaux · Schärmaschine  
Knife sharpener · Afiador de facas

Ref	€	cm	h(cm)	W	Velocidad (r.p.m.)	U.Venta
69432	102,60	26,5x10,7	9,5	18	2800	1

- **Diseñado para afilar cuchillos de acero inoxidable (lisos y dentados) y cuchillos de cerámica. Ángulo de afilado de 20°.**
- **Sistema basado en 3 etapas: grueso, fino y pulido.**
- **Eficiente y potente: equipado con un motor de 18 W de corriente continua y una rotación de alta velocidad de 2800 r.p.m.**
- **Rodillo con recubrimiento 100% de diamante en ranura gruesa (grano 360), abrasivos de diamante en ranura fina (grano 600) y resina de alta tecnología en ranura de pulido (grano 1000). Afilado rápido y seguro.**
- **Base magnética que recoge las partículas de material metálico desbastado.**
- **Base antideslizante: garantiza la estabilidad durante el uso.**

- Designed for sharpening stainless steel (smooth and serrated) and ceramic knives. 20-degree sharpening angle.
- 3-stage sharpening system: coarse, fine and polish.
- Efficient and powerful: equipped with an 18 W DC, 2800 RPM high speed motor.
- Roller with 100% diamond coating in the coarse slot (360 grit), diamond abrasives in the fine slot (600 grit) and high-tech resin in the polishing slot (1000 grit). Quick, safe sharpening.
- Magnetic base to collect metal shavings after the sharpening process.
- Non-slip base for optimum stability during use.



# Esterilizador de cuchillos

INOX CE  Professional use

- Esterilización mediante rayos ultravioletas germicidas que transforman el oxígeno en ozono, destruyendo bacterias, hongos y virus.
- Ideal para la restauración.

- La stérilisation par des rayons germicides ultraviolets qui transforment l'oxygène en ozone, détruisant les bactéries, les champignons et les virus.
- Idéal pour la restauration.

- Sterilization by ultraviolet germicidal rays that transform oxygen into ozone, destroying bacteria, fungi and viruses.
- Ideal for restoration.

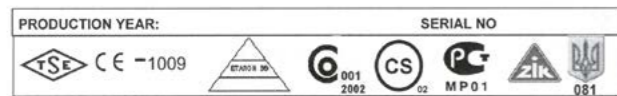

IP21

**Esterilización mediante rayos ultravioletas germicidas que transforman el oxígeno en ozono, destruyendo bacterias, hongos y virus.**

Sterilisation by ultraviolet germicidal rays that transform oxygen into ozone, destroying bacteria, fungi and viruses.

## Esterilizador de cuchillos

Armoire à stériliser · Sterilisierungsschank  
Knife sterilization · Armário esterilizador facas

Ref	€	W	Cuchillos	Tiempo	Medidas	U.Venta
<b>A</b> 39012	<b>674,00</b>	15	10	120 min	36x13x57 cm	1
<b>B</b> 39124	<b>903,50</b>	15	20	120 min	45x13x57 cm	1



# Matamosquitos

CE  Professional use

**Sin descargas eléctricas**  
Doesn't produce electric shocks



\* Se recomienda reemplazar el papel adhesivo cada 10 días pero si más de 2/3 del papel está cubierto de moscas, reemplace el papel  
It is recommended that you replace the sticky fly paper every 10 days but if more than 2/3 of the paper is covered in flies, replace the paper

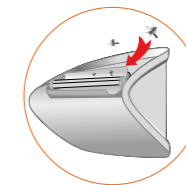

ABS  
Plastic

## Matamosquitos Decor

Anti-moustiques · Fliegenfänger  
Mosquito killer · Mata mosquitos

Ref	€	W	Número de lámparas	Área de protección	Medidas	U.Venta
39135	<b>105,30</b>	35	2	60 m2	42x23,8x17,3 cm	1

## Set de 3 láminas adhesivas

Ensemble de 3 feuilles adhesives · Set von 3 Klebe Folie  
Set of 3 adhesives sheet · Conjunto de 3 folhas adesivas

Ref	€	U.Venta
R39135C	<b>13,70</b>	1



**Vida útil de trabajo: 10.000 h**  
Useful working life: 10,000 h

**Incluye cuerda para colgar**  
Includes a cord for hanging

PP  
Polypropylene

## Matamosquitos White

Anti-moustiques · Mückenfalle  
Mosquito killer · Mata-mosquitos

Ref	€	W	Número de lámparas	Área de protección	Descargas	Vida útil	Medidas	U.Venta
39129	<b>66,70</b>	3,5	2	50 m2	2500 V	10,000 h	36x36x8,3 cm	1



new



- Diseñado para uso interior: hogar, oficinas, hoteles, locales comerciales, restaurantes, etc.
- Dispone de una lámpara LED de alta calidad y con una longitud de onda óptima para atraer a todo tipo de insectos voladores.
- Una alternativa perfecta a los insecticidas, libre de contaminación e inocuo para los humanos.
- Dispone de rejilla metálica de 2500V en el interior donde los insectos son electrocutados.
- Vida útil de trabajo: 20.000 h.
- Limpieza interior automática cada 4 horas.
- Bandeja extraíble para una fácil limpieza.
- Tiene una longitud de cable de un metro de largo.
- Diseñado para 100 m2 aproximadamente.
- Fácil instalación: podrá colocarlo en la pared (accesorios incluidos) o sobre cualquier encimera, mesa o incluso el suelo

- Conçu pour une utilisation en intérieur : logements, bureaux, hôtels, boutiques, restaurants, etc.
- Dispose de une ampoule LED de grande qualité et d'une longueur d'onde optimale pour attirer tout type d'insectes volants.
- Une alternative parfaite aux insecticides, sans contamination et inoffensive pour les humains
- Dispose d'une grille métallique de 2500V à l'intérieur, où les insectes sont électrocutés.
- Durée de vie : 20 000 h.
- Nettoyage automatique de l'intérieur toutes les 4 heures
- Plateau extractible pour faciliter le nettoyage.
- Installation facile. Inclut une corde pour l'accrocher.
- Conçu pour une surface de 100 m2 environ.
- Installation facile : vous pouvez le placer au mur (accessoires inclus) ou sur un plan de travail, une table ou même le sol

- Designed for indoor use: Home, offices, hotels, businesses, restaurants, etc.
- It has one high quality LED light with an optimal wavelength for attracting all kinds of flying insects.
- It's a perfect alternative to insecticide because it's pollution free and innocuous to humans.
- It has a 2500 V metal screen inside where insects are electrocuted.
- Useful working life: 20,000 h.
- Automatic interior cleaning every 4 hours
- Removable tray for easy cleaning.
- Easy to install Includes a cord for hanging.
- Designed for approximately 100 m2.
- Easy installation: you can place it on the wall (accessories included) or on any worktop, table or even the floor.

### Matamosquitos Limpo

Anti-moustiques électrique · Elektrofliegenfänger  
Electric mosquito killer · Mata mosquitos eléctrico

Ref	€	W	Área protección	U.Venta
39132	79,90	12	100 m2	1

**Soporte colgador**  
**Luz ultravioleta**  
**Bandeja recoge mosquitos**  
Hanger support  
Ultraviolet light  
Tray collection mosquitoes

### Matamosquitos Net

Appareil anti-moustiques noir · Fliegenfänger, schwarz  
Moskito killer black · Mata mosquitos preto

Ref	€	W	Área de protección	Número de lámparas	Medidas	U.Venta
A 39138	21,50	4	40 m2	1	12 x 12 x 25 cm	1
B 39139	24,20	6	60 m2	1	12 x 12 x 32 cm	1

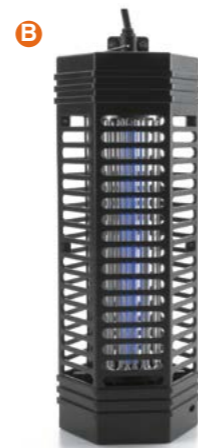

Vida útil de trabajo  
Functional lifespan  
**20.000 h**



ABS  
Plastic

### Matamosquitos Luce

Anti-moustiques · Fliegenfänger  
Moskito killer · Mata mosquitos

Ref	€	W	Área de protección	Bombillas	Descargas	Medidas	U.Venta
A 39126	92,80	11	150 m2	16-UV-A LED	4000V	34,5 x 10 x 26,5 cm	1
B 39127	113,50	13	300 m2	20 UV-A LED	4000V	49 x 10 x 26,5 cm	1



Protección  
Protection  
**IPX0**

ABS  
Plastic

### Matamosquitos Capter

Anti-moustiques · Fliegenfänger  
Moskito killer · Mata mosquitos

Ref	€	W	Área de protección	Bombillas	Medidas	U.Venta
A 39134	77,00	26	80 m2	2X10W UV-A LED	59x49x41 cm	1
B 39136	86,20	36	100 m2	2X10W UV-A LED	64x49x40,5 cm	1





## Calentadores de exterior

AL Aluminium Professional use

- **Desmontable en 3 partes: facilita el almacenaje de larga duración.**
  - **El cabezal del calentador tiene un radio de giro de 40°.**
  - **Base redonda y pesada para una mejor estabilidad y seguridad.**
  - **Seguro y respetuoso con el medio ambiente, no produce ni ruidos ni olores.**
  - **Incluye unos accesorios para el anclaje del calefactor.**
- Amovible en 3 parties: facilite le stockage à long terme.
  - La tête de chauffage a un rayon de virage de 40°.
  - Base ronde et lourde pour une meilleure stabilité et sécurité.
  - Sûr et respectueux de l'environnement, ne produit pas de bruit ou d'odeurs.
  - Comprend des accessoires pour l'ancre chauffage.
- Removable in 3 parts: facilitates long-term storage.
  - The heater head has a 40° turn radius.
  - Round and heavy base for better stability and safety.
  - Safe and environmental respectful, does not produce noise or odors.
  - Includes accessories for heating anchor.

¿Qué es la clasificación IP? · What is the IP classification?

### IP54

1º dígito; protección contra objetos y polvo 1st digit; protection against objects and dust	2º dígito; protección contra líquidos 1st digit; protection against liquids
<b>IP0:</b> Sin protección · Without protection	<b>IPX0:</b> Sin protección · Without protection
<b>IP1:</b> Protección contra objetos con un Ø mayor de 50 mm Protection against objects with Ø greater than 50 mm	<b>IPX1:</b> Protección contra gotas de agua Protection against water drops
<b>IP2:</b> Protección contra objetos con un Ø mayor a 12 mm Protection against objects with Ø greater than 12 mm	<b>IPX2:</b> Protección contra el goteo de agua con una inclinación de 15° · Protection against dripping water with an inclination of 15°
<b>IP3:</b> Protección contra objetos con un Ø mayor a 2,5 mm Protection against objects with Ø greater than 2,5 mm	<b>IPX3:</b> Protección contra pulverización Protection against spray
<b>IP4:</b> Protección contra objetos con un Ø mayor a 1 mm Protection against objects with Ø greater than 1 mm	<b>IPX4:</b> Protección contra salpicaduras · Splash protection
<b>IP5:</b> Protección contra polvo · Protection against dust	<b>IPX5:</b> Protección contra chorros de agua Protection against water jets
<b>IP6:</b> A prueba de polvo · Testing against dust	<b>IPX6:</b> Protección contra aguaceros Protection against downpours
	<b>IPX7:</b> Protección contra la inmersión durante un tiempo determinado · Protection against immersion for a certain time
	<b>IPX8:</b> Protección contra permanencia bajo agua Protection against permanence under water

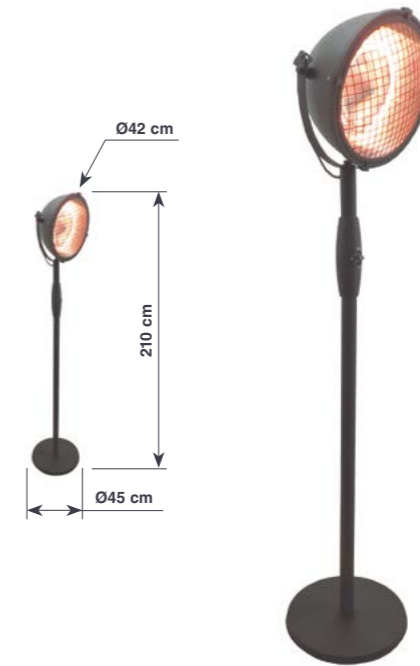
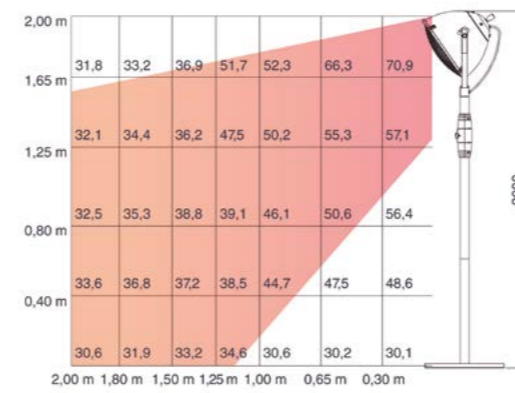

Rejilla protectora  
Protective grill



Selector nivel de calentamiento  
Heating level selector



AL Aluminium

**Calentador eléctrico de pie Black**  
Chauffage électrique sur pied · Standheizstrahler  
Free standing electric heater · Aquecedor eléctrico de pé

Ref	€	W	Calentamiento	Protección	Medidas	U.Venta
69414	467,30	2100	900-1200-2100W	IP54	45,2x45,2x209cm	1

Área de calentamiento · Heating area

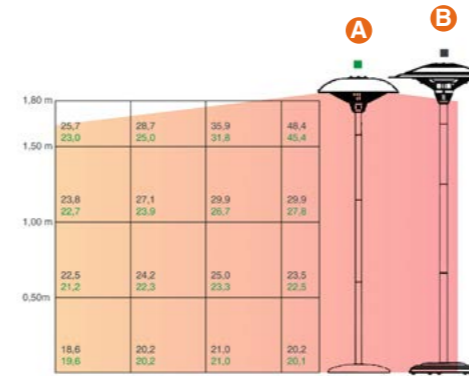

AL INOX Aluminium

**Calentador eléctrico de pie Inox**  
Rechauffeur pied · Heizung m/Ausziehbarer Fuß  
Lamp · Aquecedor com pé

Ref	€	W	Protección	Altura máxima	Medidas	U.Venta
A 69410	353,30	2100 W	IP44	2,10 m	58,5 x 1,6-2,10 cm	1
B 69411	418,80	1200/1800/3000	IP44	2,10 m	76 x 76 x 210 cm	1



Cadena de 1 m de longitud  
1 m long chain

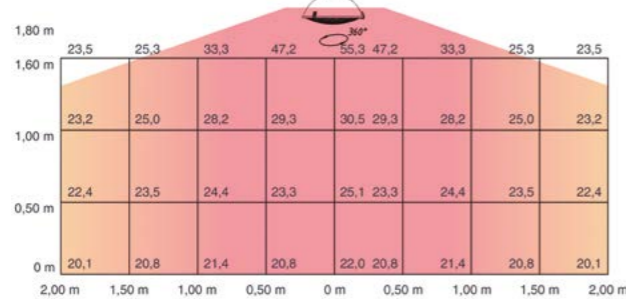

Soporte extendido  
Extended support

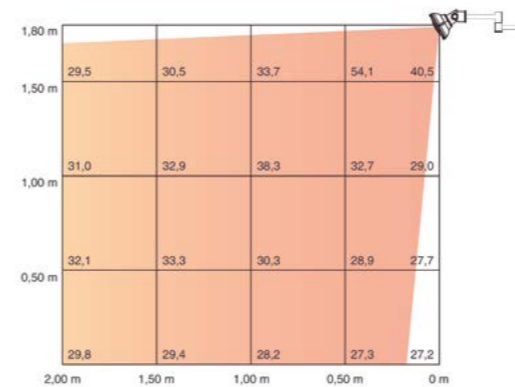

Con control remoto  
With remote control

AL  
Aluminium

**Lampara calentadora de techo**

Parasol chauffant électrique suspendu · Elektrischer Deckenheizstrahler  
Electric hanging lamp heater · Candeeiro aquecedor elétrico de teto

Ref	€	W	Número de lámparas	Calentamiento	Protección	Medidas	U.Venta
69422	215,50	2100	2	900-1200-2100 W	IP44	43 x 43 x 36,4 cm	1

Área de calentamiento · Heating area

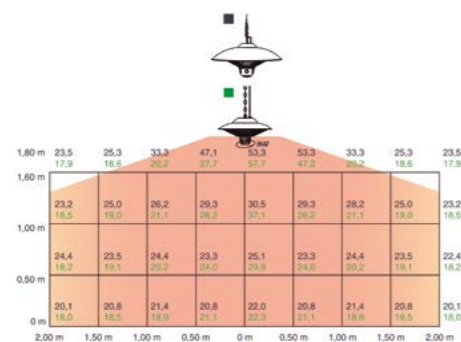

AL  
Aluminium

**Calentador de pared**

Chauffe de mur · Heizung, Hängeleiste  
Wall lamp · Aquecedora de parede

Ref	€	W	Calentamiento	Protección	Medidas	U.Venta
69424	313,00	1500	1	IP55	75 x 13 x 14 cm	1

**Rejilla protectora**  
Incluye un soporte de pared con regulación angular  
Cuerpo de aleación de aluminio anodizado  
Calefactor de fibra de carbono de alta eficiencia  
Protective grill  
Includes a wall bracket with angular adjustment  
Anodized aluminum alloy body.  
High Efficiency Carbon Fibre Heating



AL ABS  
Aluminium Plastic

**Calentador de pared Sun**

Chauffe de mur · Heizung, Hängeleiste  
Wall lamp · Aquecedora de parede

Ref	€	W	Niveles calentamiento	Protección	Número de lámparas	Medidas	U.Venta
69425	206,80	1800	1	IP65	1	65 x 21,5 x 24,5 cm	1
69426	242,80	2400	1	IP65	1	85 x 22,6 x 26,6 cm	1

**Accesorios** · Accessoires · Accessories



Base con contrapeso  
Counterbalanced base

**Soporte calentador Sun**

Support pour chauffe · Heizungshalterung  
Support for lamp · Suporte para aquecedora

Ref	€	Ø (cm)	h(cm)	U.Venta
69427	75,10	40	190	1

AL  
Aluminium

**Lámpara calentador**

Lampe chauffe · Heizelement, freihängend  
Lamp · Lâmpada aquecedora

Ref	€	W	Protección	Calentamiento	Medidas	U.Venta
69420	180,70	1500	IP24	Infrarrojos/infrared	42 x 26 cm	1
69421	243,40	900/1200/1500	IP24	Infrarrojos/infrared	58,5 x 58,5 x 35 cm	1

Área de calentamiento · Heating area

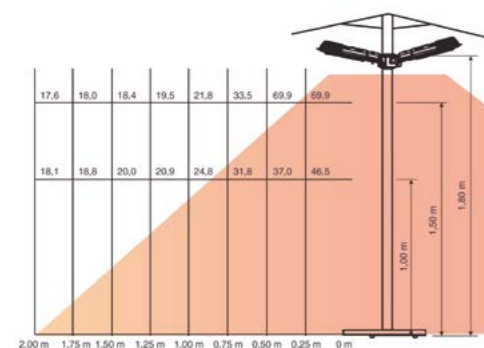

Max: Ø6 cm  
Min: Ø2, 5 cm



**Calentador con brazos abatibles**

Lampe chauffege bras rebatibles · Heizgerät Arme ausklappbar  
Heating lamp arms fold-away · Aquecedora braços rebatíveis

Ref	€	W	Protección	Calentamiento	Medidas	U.Venta
69423	240,40	2000	IP24	Infrarrojos/infrared	100 x 100 x 10,3 Kg	1

Solo para uso en exteriores · Only for outdoor use

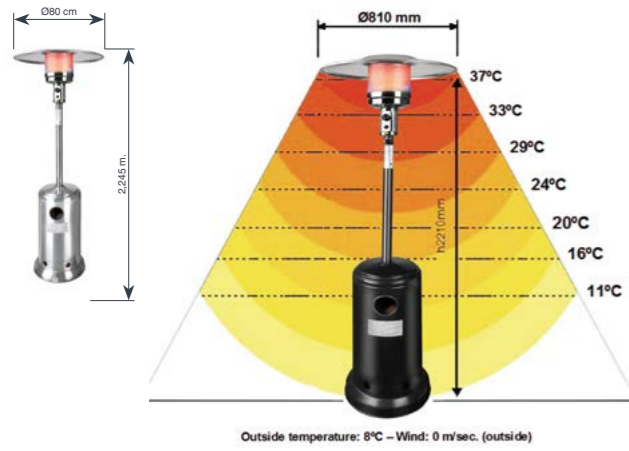

- Ideal para bares y restaurantes con mesas en el exterior.
- Indicado única y exclusivamente para exteriores.
- Disponible en dos acabados diferentes: acero inoxidable · negro.
- Malla protectora para evitar quemadura.

- Idéal pour les bars et les restaurants ayant des tables à l'extérieur.
- Destiné uniquement et exclusivement pour un usage en extérieur.
- Disponible en deux finitions différentes : acier inoxydable · noir.
- Maille de protection pour éviter les brûlures.

- Ideal for bars and restaurants with tables outside.
- Exclusively for outdoor use.
- Available in two different finishes: stainless steel · black.
- Protective mesh to prevent burns.

### Accesorios · Accessoires · Accessories



#### Funda para calentador de terraza

Housse pour chauffage de terrasse à gaz  
Abdeckung für Gas-Terrassenheizstrahler  
Cover for outdoor gas heater  
Capa protectora para aquecedor a gás para terraços

Ref	€	U.Venta
R69400N	17,80	1



#### Ruedas para calentador de terraza

Ensemble de roves pour chauffage de terrasse à gaz  
Rollen für Gas-Terrassenheizstrahler  
Wheel set for outdoor gas heater  
Jogo de rodas para aquecedor a gás para terraços

Ref	€	U.Venta	
<b>A</b> R69400B	11,40	1	Inox
<b>B</b> R69400R	11,40	1	Black

#### Calentador terraza gas

Chauffage de terrasse à gaz · Gas-Terrassenheizstrahler  
Outdoor gas heater · Aquecedor a gás para terraços

Ref	€	W	Niveles calentamiento	Consumo (g/h)	Medidas	U.Venta
<b>A</b> 69400	403,80	14 kW	Regulable	450-870 g/h	80 x 80 x 224,5 cm	1
<b>B</b> 69401	305,50	14 kW	Regulable	450 - 870 g/h	80 x 80 x 224,5 cm	1

Índice  
·  
Sommaire  
·  
Index  
·  
Index  
·  
Índice



Ref.	Pag.	Ref.	Pag.	Ref.	Pag.	Ref.	Pag.	Ref.	Pag.	Ref.	Pag.
38234	211	39041	273	39218	215	40136	44	45118	38	47318	104
38235	211	39042	273	39220	207	40140	44	45120	38	47320	37
38240	216	39043	136	39221	207	40212	45	45122	38	47320	104
38241	216	39044	136	39223	207	40214	45	45124	38	47322	37
38242	216	39047	136	39224	207	40216	45	45126	38	47322	104
38300	209	39048	136	39226	207	40218	45	45128	38	47324	37
38301	208	39049	226	39227	207	40220	45	45214	38	47324	104
38302	209	39050	226	39230	207	40318	45	45216	38	47328	37
38303	208	39060	216	39231	207	40324	45	45218	38	47328	104
38304	209	39061	216	39233	207	40420	44	45220	38	47330	37
38305	209	39064	213	39234	207	40424	44	45320	39	47330	104
38310	209	39075	215	39236	207	40426	44	45320	103	47418	37
38311	208	39088	207	39237	207	40428	44	45322	39	47418	104
38312	209	39089	207	39262	207	40619	45	45322	103	47420	37
38313	208	39090	207	39262	220	40619	101	45324	39	47420	104
38314	209	39091	207	39263	220	40620	45	45324	103	47422	37
38315	209	39092	207	39264	220	40621	45	45326	39	47422	104
38316	209	39093	207	39266	220	40621	101	45326	103	47424	37
38321	209	39100	216	39402	363	40622	45	45328	39	47424	104
38322	208	39101	216	39402	363	40623	45	45328	103	47428	37
38330	208	39108	219	39403	363	40623	101	45330	39	47428	104
38331	209	39109	219	39404	363	40624	45	45330	103	47430	37
38332	209	39110	212	39405	364	40625	45	45420	39	47430	104
38340	208	39112	212	39406	364	40625	101	45420	103	47620	37
38341	209	39114	212	39407	364	40626	45	45422	39	47624	37
38342	208	39115	212	39410	364	40627	45	45422	103	47628	37
38350	209	39116	212	39411	364	40627	101	45424	39	48016	61
38360	209	39118	212	39413	363	40628	45	45424	103	48020	61
38361	208	39121	212	39414	363	40629	45	45426	39	48024	61
38362	209	39124	560	39415	364	40629	101	45426	103	48028	61
38363	209	39125	212	39420	364	40632	45	45428	39	48116	61
38370	209	39126	563	39423	363	40636	45	45428	103	48120	61
38371	208	39127	563	39424	363	40640	45	45430	39	48124	61
38380	209	39129	561	39430	364	40712	45	45430	103	48128	61
38381	209	39132	562	39433	363	40714	45	45624	38	48214	61
38390	209	39134	563	39434	363	40716	45	45626	38	48216	61
38391	209	39135	561	39441	312	40718	45	45628	38	48218	61
39000	213	39136	563	39445	312	40916	45	45728	39	48220	61
39001	213	39138	562	39450	312	40918	45	45728	103	48624	61
39004	213	39139	562	40016	44	40920	45	45729	39	48628	61
39008	219	39140	558	40018	44	40922	45	45729	103	48720	98
39009	219	39140	362	40020	44	40924	45	45828	39	48720	61
39010	213	39160	558	40022	44	40926	45	45828	103	48724	98
39012	560	39160	362	40024	44	40928	45	45829	39	48724	61
39014	212	39161	558	40026	44	40932	45	45829	103	48728	98
39015	213	39161	362	40028	44	40936	45	45916	39	48728	61
39016	212	39162	362	40032	44	40940	45	45918	39	48916	61
39017	212	39163	362	40036	44	44320	104	45920	39	48920	61
39018	213	39164	362	40040	44	44324	104	45922	39	48924	61
39020	212	39165	206	40116	44	44328	104	45924	39	48928	61
39021	212	39166	362	40118	44	44420	104	45926	39	49014	214
39024	212	39169	206	40120	44	44424	104	45928	39	49016	214
39025	212	39170	206	40121	45	44428	104	47020	37	49017	214
39027	212	39171	206	40122	44	45016	38	47024	37	49021	214
39028	212	39172	206	40124	44	45018	38	47028	37	49024	214
39029	213	39185	212	40125	45	45020	38	47128	37	49025	214
39030	212	39208	215	40126	44	45022	38	47214	37	49027	214
39037	218	39210	215	40128	44	45024	38	47216	37	49030	214
39038	218	39212	215	40129	45	45026	38	47218	37	49110	214
39039	219	39213	215	40132	44	45028	38	47220	37	49112	214
39040	273	39215	215	40133	45	45116	38	47318	37	49116	214

Ref.	Pag.	Ref.	Pag.	Ref.	Pag.	Ref.	Pag.	Ref.	Pag.	Ref.	Pag.
49121	214	50132	24	50541	149	50837	149	54025	21	54221	22
49185	214	50132S	24	50550	26	50840	322	54025S	21	54224	22
49210	214	50135	24	50550	112	50840	178	54028	20	54225	22
49212	214	50135S	24	50551	149	50841	149	54028S	20	54225N	22
49216	214	50136	24	50560	26	50845	322	54029	21	54228	22
50016	23	50136S	24	50560	112	50845	178	54029S	21	54229	22
50016S	23	50139	24	50561	149	50846	149	54032	20	54229N	22
50017	24	50139S	24	50570	26	50850	322	54032S	20	54621	22
50017S	24	50140	24	50570	112	50850	178	54033	21	54625	22
50020	23	50140S	24	50624	25	50851	149	54033S	21	54629	22
50020S	23	50145	24	50624	106	50916	26	54036	20	54633	22
50021	24	50145S	24	50624S	25	50918	26	54036S	20	54636	22
50021S	24	50150	24	50624S	106	50920	26	54037	21	54636	106
50024	23	50150S	24	50625	25	50924	26	54037S	21	54636S	22
50024S	23	50160	24	50628	25	50928	26	54040	20	54636S	106
50025	24	50160S	24	50628	106	50932	26	54040S	20	54637	22
50025S	24	50212	25	50628S	25	50934	71	54041	21	54640	22
50028	23	50214	25	50628S	106	50936	26	54041S	21	54640	106
50028S	23	50216	25	50629	25	50940	26	54045	20	54640S	22
50029	24	50217	25	50632	25	50945	26	54045S	20	54640S	106
50029S	24	50218	25	50632	106	50950	26	54046	21	54645	22
50032	23	50219	25	50632S	25	50960	26	54046S	21	54645	106
50032S	23	50220	25	50632S	106	51216	26	54050	20	54645S	22
50033	24	50221	25	50633	25	51218	26	54050S	20	54645S	106
50033S	24	50224	25	50636	25	51220	26	54051	21	54650	22
50036	23	50225	25	50636	106	51222	26	54051S	21	54650	106
50036S	23	50225N	26	50636S	25	51224	26	54119	21	54650S	22
50037	24	50228	25	50636S	106	51620	80	54119S	21	54650S	106
50037S	24	50229	25	50637	25	51621	80	54120	21	54916	71
50040	23	50229N	26	50640	25	51624	80	54120S	21	54916	22
50040S	23	50300	322	50640	106	51625	80	54123	21	54920	71
50041	24	50301	451	50640S	25	51628	80	54123S	21	54920	22
50041S	24	50320	146	50640S	106	51629	80	54124	21	54924	71
50045	23	50323	322	50645	25	51632	80	54124S	21	54924	22
50045S	23	50323S	322	50645	106	51633	80	54127	21	54928	71
50046	24	50324	146	50645S	25	51636	80	54127S	21	54928	22
50046S	24	50327	322	50645S	106	51637	80	54128	21	54932	71
50050	23	50327S	322	50650	25	51640	80	54128S	21	54932	22
50050S	23	50328	146	50650	106	51641	80	54131	21	54936	71
50051	24	50332	149	50650S	25	51720	80	54131S	21	54936	22
50051S	24	50333	322	50650S	106	51724	80	54132	21	54940	71
50060	23	50333S	322	50660	25	51728	80	54132S	21	54940	22
50060S	23	50334	146	50660	106	51732	80	54135	21	54945	71
50061	24	50336	149	50660S	25	51736	80	54135S	21	54945	22
50061S	24	50337	322	50660S	106	51740	80	54136	21	54950	71
50116	24	50337S	322	50717	26	53720	100	54136S	21	54950	22
50116S	24	50338	146	50721	26	53721	100	54139	21	55216	22
50119	24	50340	149	50815	71	53724	100	54139S	21	55220	22
50119S	24	50341	322	50816	71	53725	100	54140	21	55224	

Ref.	Pag.	Ref.	Pag.	Ref.	Pag.	Ref.	Pag.	Ref.	Pag.	Ref.	Pag.
55412	439	55473	439	55534	440	55595	440	55656	443	55732	441
55413	439	55474	439	55535	440	55596	440	55657	443	55733	441
55414	439	55475	439	55536	440	55597	440	55658	443	55734	441
55415	439	55476	439	55537	440	55598	440	55659	443	55735	441
55416	439	55477	439	55538	440	55599	440	55660	443	55736	441
55417	439	55478	439	55539	440	55600	440	55661	443	55737	441
55418	439	55479	439	55540	440	55601	440	55662	443	55738	441
55419	439	55480	439	55541	440	55602	440	55663	443	55739	441
55420	439	55481	439	55542	440	55603	440	55664	443	55740	441
55421	439	55482	439	55543	440	55604	440	55665	443	55741	441
55422	439	55483	439	55544	440	55605	440	55666	443	55742	441
55423	439	55484	439	55545	440	55606	440	55667	443	55743	441
55424	439	55485	439	55546	440	55607	440	55668	443	55744	441
55425	439	55486	439	55547	440	55608	440	55669	443	55745	441
55426	439	55487	439	55548	440	55609	440	55670	443	55746	441
55427	439	55488	439	55549	440	55610	440	55671	443	55747	441
55428	439	55489	439	55550	440	55611	440	55672	443	55748	441
55429	439	55490	439	55551	440	55612	440	55673	443	55749	441
55430	439	55491	439	55552	440	55613	440	55674	443	55750	441
55431	439	55492	439	55553	440	55614	440	55675	443	55751	441
55432	439	55493	439	55554	440	55615	440	55676	443	55752	441
55433	439	55494	439	55555	440	55616	440	55677	443	55753	441
55434	439	55495	439	55556	440	55617	440	55678	443	55754	441
55435	439	55496	439	55557	440	55618	440	55679	443	55755	441
55436	439	55497	439	55558	440	55619	440	55680	443	55756	441
55437	439	55498	439	55559	440	55620	440	55681	443	55757	441
55438	439	55499	439	55560	440	55621	440	55682	443	55758	441
55439	439	55500	439	55561	440	55622	440	55683	443	55759	441
55440	439	55501	439	55562	440	55623	440	55684	443	55760	441
55441	439	55502	439	55563	440	55624	440	55700	438	55761	441
55442	439	55503	439	55564	440	55625	440	55701	438	55762	441
55443	439	55504	439	55565	440	55626	440	55702	438	55763	441
55444	439	55505	439	55566	440	55627	440	55703	438	55764	441
55445	439	55506	439	55567	440	55628	440	55704	438	55765	441
55446	439	55507	439	55568	440	55629	440	55705	438	55766	441
55447	439	55508	439	55569	440	55630	440	55706	438	55767	441
55448	439	55509	439	55570	440	55631	443	55707	438	55768	441
55449	439	55510	439	55571	440	55632	443	55708	438	55769	441
55450	439	55511	439	55572	440	55633	443	55709	441	55770	441
55451	439	55512	439	55573	440	55634	443	55710	441	55771	441
55452	439	55513	439	55574	440	55635	443	55711	441	55772	441
55453	439	55514	439	55575	440	55636	443	55712	441	55773	441
55454	439	55515	439	55576	440	55637	443	55713	441	55774	441
55455	439	55516	439	55577	440	55638	443	55714	441	55775	441
55456	439	55517	439	55578	440	55639	443	55715	441	55776	441
55457	439	55518	439	55579	440	55640	443	55716	441	55777	441
55458	439	55519	439	55580	440	55641	443	55717	441	55778	441
55459	439	55520	440	55581	440	55642	443	55718	441	55779	441
55460	439	55521	440	55582	440	55643	443	55719	441	55780	441
55461	439	55522	440	55583	440	55644	443	55720	441	55781	441
55462	439	55523	440	55584	440	55645	443	55721	441	55782	441
55463	439	55524	440	55585	440	55646	443	55722	441	55783	441
55464	439	55525	440	55586	440	55647	443	55723	441	55784	441
55465	439	55526	440	55587	440	55648	443	55724	441	55785	441
55466	439	55527	440	55588	440	55649	443	55725	441	55786	441
55467	439	55528	440	55589	440	55650	443	55726	441	55787	441
55468	439	55529	440	55590	440	55651	443	55727	441	55788	441
55469	439	55530	440	55591	440	55652	443	55728	441	55789	441
55470	439	55531	440	55592	440	55653	443	55729	441	55790	441
55471	439	55532	440	55593	440	55654	443	55730	441	55791	441
55472	439	55533	440	55594	440	55655	443	55731	441	55792	441

Ref.	Pag.	Ref.	Pag.	Ref.	Pag.	Ref.	Pag.	Ref.	Pag.	Ref.	Pag.
55793	441	55854	442	55915	442	55976	444	56620	35	57220	28
55794	441	55855	442	55916	442	55977	444	56624	35	57221	28
55795	441	55856	442	55917	442	55978	444	56720	35	57224	28
55796	441	55857	442	55918	442	55979	444	56720	102	57225	28
55797	441	55858	442	55919	442	55980	444	56724	35	57302	436
55798	441	55859	442	55920	442	55981	444	56724	102	57317	436
55799	441	55860	442	55921	442	55982	444	56728	35	57320	436
55800	441	55861	442	55922	442	55983	444	56728	102	57321	437
55801	441	55862	442	55923	442	55984	444	56732	35	57322	437
55802	441	55863	442	55924	442	56007	436	56732	102	57325	437
55803	441	55864	442	55925	442	56008	436	56820	35	57330	436
55804	441	55865	442	55926	442	56009	436	56820	102	57435	437
55805	441	55866	442	55927	442	56010	436	56824	35	57624	28
55806	441	55867	442	55928	442	56011	436	56824	102	57624	106
55807	441	55868	442	55929	442	56012	436	56828	35	57625	28
55808	441	55869	442	55930	442	56013	436	56828	102	57628	28
55809	441	55870	442	55931	444	56014	436	56832	35	57628	106
55810	441	55871	442	55932	444	56015	436	56832	102	57629	28
55811	441	55872	442	55933	444	56212	428	56914	35	57632	28
55812	441	55873	442	55934	444	56216	428	56916	35	57632	106
55813	441	55874	442	55935	444	56302	436	56918	35	57636	28
55814	441	55875	442	55936	444	56317	436	56920	35	57636	106
55815	441	55876	442	55937	444	56320	436	56924	35	57640	28
55816	441	55877	442	55938	444	56321	437	56928	35	57640	106
55817	441	55878	442	55939	444	56322	437	56932	35	57717	28
55818	441	55879	442	55940	444	56325	437	57007	436	57721	28
55819	441	55880	442	55941	444	56330	436	57008	436	57916	28
55820	442	55881	442	55942	444	56412	428	57009	436	57920	28
55821	442	55882	442	55943	444	56416	428	57010	436	57924	28
55822	442	55883	442	55944	444	56435	437	57011	436	57928	28
55823	442	55884	442	55945	444	56502	437	57012	436	57932	28
55824	442	55885	442	55946	444	56507	437	57013	436	57936	28
55825	442	55886	442	55947	444	56508	437	57014	436	57940	28
55826	442	55887	442	55948	444	56509	437	57015	436	58050	292
55827	442	55888	442	55949	444	56510	437	57016	27	58150	292
55828	442	55889	442	55950	444	56511	437	57017	27	58151	292
55829	442	55890	442	55951	444	56512	437	57020	27	58152	292
55830	442	55891	442	55952	444	56513	437	57021	27	58153	292
55831	442	55892	442	55953	444	56514	437	57024	27	58250	292
55832	442	55893	442	55954	444	56515	437	57025	27	58251	292
55833	442	55894	442	55955	444	56517	437	57028	27	58252	292
55834	442	55895	442	55956	444	56520	437	57029	27	58253	292
55835	442	55896	442	55957	444	56522	436	57032	27	58450	292
55836	442	55897	442	55958	444	56523	436	57033	27	60000	199
55837	442	55898	442	55959	444	56524	437	57036	27	60001	217
55838	442	55899	442	55960	444	56525	437	57037	27	60002	126
55839	442	55900	442	55961	444	56526	437	57040			



Ref.	Pag.	Ref.	Pag.	Ref.	Pag.	Ref.	Pag.	Ref.	Pag.	Ref.	Pag.	Ref.	Pag.	Ref.	Pag.	Ref.	Pag.	Ref.	Pag.	Ref.	Pag.		
60020	178	60160	107	60311	146	60393	194	60475	225	60582	222	60833	107	61071	232	61251	160	61524	329	61709	186	61905	265
60021	154	60161	110	60312	126	60394	199	60476	225	60586	222	60834	107	61072	232	61308	126	61529	329	61710	185	61906	265
60022	217	60170	65	60313	146	60397	198	60477	225	60587	222	60839	107	61073	232	61310	126	61530	112	61711	186	61907	265
60023	217	60170	254	60314	126	60398	191	60478	225	60588	222	60840	107	61078	232	61312	126	61534	329	61712	183	61908	264
60024	322	60170	110	60315	146	60399	191	60479	225	60591	223	60850	101	61095	260	61316	147	61535	112	61714	185	61909	265
60024	178	60172	65	60316	126	60401	155	60480	225	60592	223	60854	101	61096	260	61318	147	61540	112	61715	185	61912	168
60026	154	60172	254	60316P	146	60402	147	60481	225	60594	223	60858	101	61097	260	61319	299	61545	112	61716	557	61921	264
60027	154	60172	110	60316V	146	60403	155	60482	139	60595	224	60860	202	61098	260	61320	147	61550	112	61716	182	61925	168
60028	322	60175	65	60317	146	60404	139	60483	139	60599	197	60922	259	61101	206	61321	299	61590	329	61717	183	61925A	168
60028	178	60175	254	60318	146	60405	225	60484	139	60600	225	60924	259	61102	206	61323	147	61591	329	61720	185	61925R	168
60030	154	60175	110	60318P	146	60406	225	60485	223	60601	225	60928	259	61103	206	61326	147	61592	329	61721	186	61940	168
60031	154	60180	65	60319	147	60407	225	60486	222	60602	225	60950	101	61107	255	61330	147	61608	153	61722	186	61940A	168
60032	322	60180	254	60319V	146	60408	126	60487	222	60603	225	60954	101	61109	255	61331	300	61610	264	61724	182	61940R	168
60032	178	60180	110	60320	146	60409	126	60488	223	60604	225	60958	101	61110	231	61335	147	61615	328	61725	183	61950	282
60034	119	60182	110	60320P	146	60410	126	60491	223	60605	225	61002	452	61112	255	61341	201	61615	328	61726	184	61951	301
60036	322	60184	110	60321	147	60411	126	60492	223	60606	225	61002	261	61113	231	61342	201	61620	328	61727	184	61952	301
60036	178	60186	110	60322	146	60412	126	60495	223	60610	144	61002	261	61116	231	61343	201	61620	328	61730	557	61953	301
60037	121	60188	110	60322P	146	60413	126	60497	164	60612	144	61004	261	61121	231	61344	201	61621	328	61730	182	61953	301
60038	121	60190	65	60323	147	60414	126	60498	164	60655	135	61007	255	61122	231	61346	201	61622	328	61740	187	61954	302
60039	121	60190	254	60324	146	60415	126	60499	197	60656	135	61008	260	61124	258	61347	201	61623	328	61742	187	61955	301
60040	322	60192	65	60324P	146	60416	126	60500	224	60657	135	61009	255	61126	258	61348	201	61624	329	61743	187	61956	301
60040	178	60192	254	60325	147	60417	126	60501	224	60658	135	61010	232	61127	258	61349	201	61625	328	61801	399	61965	282
60041	119	60196	65	60326	146	60419	126	60502	224	60659	135	61012	260	61128	258	61351	199	61626	328	61801	260	61970	168
60044	121	60196	254	60327	307	60420	138	60503	224	60700	136	61015	232	61129	277	61353	194	61627	329	61802	399	61970A	168
60045	121	60226	158	60329	195	60421	138	60507	126	60701	452	61016	232	61130	277	61354	200	61629	329	61802	260	61970R	168
60046	121	60227	158	60331	203	60422	139	60508	126	60702	452	61019	232	61131	277	61355	194	61630	329	61803	399	61974	340
60048	154	60232	107	60332	203	60423	126	60509	126	60710	136	61021	232	61132	277	61359	198	61631	329	61803	260	61977	340
60050	320	60236	107	60334	195	60424	142	60510	204	60726	138	61023	260	61133	163	61360	201	61634	329	61806	399	61978	340
60050	177	60240	107	60335	200	60425	138	60511	204	60731	136	61024	119	61134	163	61361	272	61635	329	61806	260	61979	340
60051	320	60251	165	60336	199	60426	138	60512	155	60740	136	61025	261	61135	163	61362	167	61636	329	61809	399	61980	340
60051	177	60253	165	60340	195	60427	126	60513	204	60746	136	61029	232	61136	163	61363	200	61639	329	61809	260	62001	290
60055	321	60255	165	60343	204	60429	143	60514	155	60750	397	61030	119	61137	405	61364	200	61640	329	61811	172	62003	290
60055	177	60257	165	60344	197	60430	138	60516	155	60751	397	61031	232	61138	405	61365	200	61641	329	61812	172	62004	260
60056	118	60258	159	60346	193	60431	160	60517	155	60752	397	61033	119	61139	405	61366	201	61644	329	61813	172	62004	224
60059	217	60259	159	60347	193	60432	160	60518	155	60753	397	61034	119	61140	405	61373	327	61645	329	61815	172	62010	290
60061	217	60260	134	60348	152	60434	138	60520	178	60754	397	61036	119	61150	255	61374	327	61646	329	61816	172	62022	288
60062	119	60261	134	60349	152	60435	139	60521	225	60755	397	61040	253	61151	255	61375	327	61649	329	61817	172	62023	290
60066	217	60262	134	60350	198	60438	139	60522	225	60756	397	61041	232	61152	255	61403	166	61650	328	61820	230	62026	288
60068	119	60263	134	60351	193	60442	138	60523	223	60757	397	61042	253	61153	255	61407	340	61651	328	61821	403	62029	288
60070	119	60264	134	60352	193	60443	138	60524	198	60760	136	61043	232	61154	255	61408	167	61655	328	61823	403	62031	287
60072	224	60265	134	60353	193	60444	193	60529	198	60761	136	61044	232	61155	255	61409	259	61660	328	61825	230	62033	287
60073	119	60266	134	60354	193	60445	139	60533	326	60776	136	61045	254	61200	165	61410	126	61664	477	61828	230	62035	290
60080	121	60267	134	60356	203	60446	139	60534	326	60781	397	61046	254	61201	165	61411	126	61668	480	61830	230	62036	287
60081	121	60268	135	60357	203	60455	225	60547	193	60782	397	61047	254	61221	401	61412	126	61669	480	61831	230	62046	288
60082	121	60269	135	60359	559	60456	225	60555	224	60783	397	61051	232	61222	401	61413	126	61671	478	61832	230	62048	288
60127	110	60270	135	60359	221	60457	225	60559	205	60784	397	61052	255	61223	401	61414	117	61672	476	61835	230	62051	287
60130	107	60275	203	60361	195	60458	225	60560	202	60785	397	61053	255	61224	401	61415	259	61673	476	61836	230	62054	287
60131	110	60276	203	60365	198	60460	202	60562	142	60786	397	61055	255	61230	396	61416	167	61674	476	61838	230	62056	287
60134	107	60277	156	60366	191	60461	139	60569	225	60787	397	61056	255	61231	396	61418	167	61675	476	61840	230	62060	290
60135	110	60288	152	60367	191	60462	139	60570	225	60791	136	61057	254	61232	396	61420	166	61678	478	61841	231	62071	287
60138	107	60299	197	60368	191	60463	139	60571	225	60802	189	61058	254	61233	396	61421	139	61679	479	61843	230	62074	287
60139	110	60300	147	60369	191	60464	139	60572	225	60803	189	61059	254	61234	396	61422	166	61681	478	61845	230	62076	287
60141	110	60301	200	60372	191	60465	139	60573	225	60804	189	61060	254	61235	396	61424	259	61682	479	61848	230	62081	287
60142	107	60302	200	60377	191	60467	139	60574	225	60805	189	61062	255	61239	253	61425	166	61683	479	61850	230	62084	287
60144	110	60303	200	60378	191	60468	139	60575	225	60812	259	61063	255	61240	253	61430	259	61700	557	61860	230	62086	287
60146	107	60305	200	60380	191	60469	139	60576	225	60814													

Ref.	Pag.	Ref.	Pag.	Ref.	Pag.	Ref.	Pag.	Ref.	Pag.	Ref.	Pag.
62124	287	62317	342	62453	188	62547	281	62690	147	62841	231
62126	287	62317	269	62454	188	62548	281	62691	147	62845	230
62135	290	62318	268	62456	189	62551	264	62692	147	62850	230
62141	289	62320	299	62457	189	62555	264	62697	147	62862	264
62153	289	62321	299	62458	188	62556	282	62698	147	62863	271
62160	290	62322	299	62459	188	62559	282	62702	302	62864	264
62161	289	62325	295	62460	280	62563	279	62715	302	62865	271
62163	289	62326	308	62472	392	62564	279	62716	302	62866	264
62168	289	62329	308	62473	392	62575	279	62720	302	62867	264
62173	289	62330	308	62475	392	62579	279	62721	302	62868	403
62178	289	62334	269	62478	298	62585	281	62725	302	62869	403
62180	289	62336	299	62479	298	62588	281	62726	302	62872	271
62181	305	62337	308	62480	281	62596	394	62732	148	62873	271
62182	305	62337	269	62481	280	62597	394	62736	148	62874	271
62183	289	62338	299	62483	280	62598	279	62740	321	62875	271
62184	306	62341	308	62484	280	62599	279	62740	176	62879	270
62185	306	62344	205	62485	280	62600	341	62741	318	62884	148
62186	289	62346	299	62486	280	62601	128	62741	175	62892	156
62187	306	62352	308	62487	188	62603	128	62742	318	62895	198
62210	290	62353	268	62491	279	62604	128	62742	175	62896	156
62215	290	62354	300	62492	279	62605	128	62750	240	62897	156
62216	290	62355	295	62495	188	62606	128	62751	240	62898	259
62220	290	62356	299	62496	279	62607	128	62753	240	62899	259
62225	290	62359	205	62498	188	62608	128	62754	240	62901	329
62235	290	62362	300	62500	188	62609	128	62755	240	62902	157
62252	264	62363	307	62503	128	62610	147	62756	240	62903	265
62253	304	62364	300	62504	128	62611	147	62757	240	62904	265
62254	304	62365	300	62505	128	62612	147	62759	240	62905	265
62255	304	62366	300	62506	128	62613	147	62761	240	62906	265
62260	290	62367	300	62507	128	62614	147	62762	240	62908	272
62261	304	62368	300	62512	150	62615	147	62764	240	62912	161
62262	304	62371	300	62513	150	62616	147	62766	240	62924	269
62263	304	62373	300	62515	150	62617	147	62768	240	62926	270
62264	304	62380	260	62516	150	62618	147	62769	240	62928	270
62265	304	62388	307	62517	150	62619	147	62770	240	62929	270
62266	304	62389	299	62519	319	62620	147	62771	240	62930	269
62267	304	62392	302	62519	186	62621	147	62772	240	62931	269
62268	304	62393	302	62521	150	62623	147	62780	240	62933	271
62270	295	62394	259	62522	280	62626	305	62781	240	62938	270
62271	299	62399	269	62523	280	62627	305	62782	240	62939	270
62272	299	62404	260	62524	150	62628	305	62783	240	62940	269
62273	299	62406	303	62525	264	62630	128	62784	240	62941	261
62276	295	62410	280	62528	188	62633	321	62785	240	62942	164
62277	295	62414	306	62530	112	62633	176	62786	240	62943	164
62278	308	62415	280	62530A	112	62635	281	62787	240	62946	161
62279	308	62424	259	62531	150	62636	281	62791	240	62951	259
62280	393	62430	280	62532	189	62673	192	62792	240	62952	161
62281	393	62435	136	62533	189	62675	192	62793	240	62954	271
62283	393	62436	299	62534	282	62676	192	62811	128	62955	271
62285	307	62438	306	62535	112	62677	138	62814	266	62956	271
62286	307	62439	299	62535A	112	62678	140	62816	266	62957	147
62288	295	62440	281	62536	281	62679	140	62817	284	62958	152
62289	451	62441	280	62537	281	62680	147	62817	267	62959	147
62300	298	62442	280	62538	281	62683	192	62818	266	62962	136
62302	308	62443	280	62540	112	62684	272	62820	230	62963	136
62303I	307	62444	280	62540A	112	62684	192	62821	271	62964	428
62304I	307	62445	136	62541	394	62685	192	62823	266	62970	259
62306	308	62446	136	62542	394	62686	192	62825	230	62971	259
62306	269	62448	281	62545	394	62687	192	62830	230	62972	136
62307	268	62450	188	62545A	112	62688	192	62835	230	62973	272
62315	299	62452	188	62546	281	62689	192	62840	230	62974	272

Ref.	Pag.	Ref.	Pag.	Ref.	Pag.	Ref.	Pag.	Ref.	Pag.	Ref.	Pag.	Ref.	Pag.	Ref.	Pag.	Ref.	Pag.	Ref.	Pag.	Ref.	Pag.	Ref.	Pag.
62976	273	63078	401	63244	399	63365	241	63491	227	63623	109												
62978	268	63079	401	63250	399	63367	241	63492	404	63624	87												
62980	195	63080	244	63251	399	63368	241	63493	404	63625	109												
62981	268	63081	244	63252	399	63369	241	63494	404	63626	87												
62982	268	63082	244	63253	399	63370	242	63514	126	63627	109												
62983	269	63083	244	63254	399	63372	242	63516	126	63628	87												
62984	269	63084	244	63255	399	63373	242	63518	126	63629	109												
62985	269	63085	244	63261	241	63374	242	63520	126	63631	109												
62986	268	63086	244	63262	241	63375	241	63524	126	63632	87												
62987	149	63087	244	63263	241	63379	242	63528	126	63633	109												
62988	126	63088	244	63264	241	63380	242	63531	238	63635	109												
62989	421	63089	244	63265	241	63381	247	63532	238	63636	87												
62998	421	63090	244	63267	241	63382	247	63533	238	63637	109												
63005	218	63091	244	63268	241	63383	247	63534	238	63639	109												
63008	277	63092	244	63269	241	63384	247	63535	238	63640	87												
63010	311	63093	244	63270	242	63385	247	63536	238	63641	109												
63012	311	63094	244	63272	242	63386	247	63541	238	63642	89												
63013	311	63096	401	63273	242	63387	247	63542	238	63643	109												
63015	218	63097	401	63274	242	63388	247	63543	238	63644	89												
63016	272	63098	401	63275	241	63389	247	63544	238	63647	109												
63017	272	63099	401	63279	242	63390	248	63545	238	63651	109												
63018	311	63115	109	63280	242	63391	248	63546	238	63656	109												
63019	309	63130	109	63281	254	63392	248	63551	239	63661	109												
63021	309	63131	537	63282	254	63393	248	63552	239	63666	109												
63022	309	63132	537	63283	254	63394	248	63553	239	63671	109												
63028	311	63133	537	63284	241	63395	248	63554	239	63681	109												
63031	552	63134	282	63285	241	63396	248	63555	239	63691	109												
63031	310	63135	282	63286	241	63397	248	63556	239	63700	110												
63033	312	63137	309	63287	242	63398	248	63557	238	63712	88												
63036	277	63138	282	63302	450	63399	248	63558	238	63714	88												
63041	277	63139	282	63302	261	63400	248	63567	238	63720	87												
63042	277	63141	303	63303	450	63401	248	63568	238	63724	87												
63043	277	63143	303	63304	260	63403	242	63570	240	63725	88												
63044	311	63144	303	63305	450	63404	241	63571	240	63726	87												
63046	311	63146	303	63307	450	63405	241	63572	240	63727	88												
63047	311	63147	303	63310	280	63406	241	63573	239	63728	87												
63048	309	63148	303	63312	450	63407	242	63577	239	63729	86												
63049	270	63149	303	63315	280	63408	242	63580	240	63731	110												
63051	312	63180	243	63319	450	63419	88	63581	240	63732	87												
63054	552	63181	243	63320	280	63423	88	63582	240	63733	86												
63054	310	63182	243	63322	89	63424	88	63585	239	63736	87												
63055	309	63183	243	63326	89	63428	88	63586	342	63740	87												
63056	552	63184	243	63331	453	63432	88	63586	239	63741	110												
63056	310	63185	243	63332	453	63471	404	63589	238	63751	110												
63057	552	63186	243	63335	450	63472	404	63599	238	63761	110												
63057	310	63187	243	63336	296	63473	404	63600	240	63771													

Ref.	Pag.	Ref.	Pag.	Ref.	Pag.	Ref.	Pag.	Ref.	Pag.	Ref.	Pag.	Ref.	Pag.	Ref.	Pag.	Ref.	Pag.	Ref.	Pag.	Ref.	Pag.	Ref.	Pag.
63843	235	63955	237	64465	132	65418	297	66140Z	419	66310	420	66520Z	419	66763	346	66866	371	66911Z	421	66994	431	67050	343
63844	235	63956	237	64466	132	65420	297	66142	419	66310E	425	66520Z	223	66764	346	66867	367	66912	421	66995	431	67051	549
63845	235	63957	237	64467	132	65436	297	66142Z	419	66310H	423	66540	419	66765	346	66868	367	66912H	423	66996	431	67052	343
63846	235	63958	237	64468	132	65440	297	66155	419	66310J	424	66540Z	419	66765E	425	66870	357	66912P	422	66997	431	67053	343
63847	235	63959	237	64469	132	65450	297	66155Z	419	66310P	422	66540Z	223	66765J	424	66871	357	66912Z	421	66998	431	67055	343
63848	235	63960	237	64470	132	65514	307	66165	419	66310Z	420	66550	428	66766	346	66872	357	66913H	423	67000	336	67056	343
63849	235	63961	237	64471	132	65614	297	66165E	425	66315	420	66551	429	66767	346	66874	357	66913P	422	67001	319	67058	343
63850	235	63962	237	64480	131	65618	297	66165H	423	66315H	423	66552	429	66768	346	66875	357	66914H	423	67002	343	67059	343
63851	235	63963	237	64481	131	65620	297	66165J	424	66315P	422	66553	429	66769	346	66877	357	66914P	422	67004	143	67062	343
63852	235	63964	237	64482	131	65636	297	66165P	422	66315Z	420	66555	428	66772	276	66890	367	66916	342	67005	324	67063	343
63853	235	63965	236	64483	131	65640	297	66165Z	419	66320	420	66556	429	66773	276	66891	367	66916H	423	67006	324	67065	343
63854	234	63966	236	64484	131	65650	297	66167	419	66320H	423	66557	429	66774	452	66892	367	66916P	422	67007	319	67066	343
63855	234	63967	237	64490	327	66002	419	66167Z	419	66320P	422	66565	419	66775	349	66900P	421	66917	342	67008	200	67069	343
63856	235	63968	237	64491	327	66002Z	419	66172	421	66320Z	420	66565E	425	66776	349	66901	421	66920	421	67009	201	67070	343
63857	235	63969	237	64515	266	66010	419	66172P	421	66340	420	66565J	424	66777	349	66901D	421	66921	421	67011	323	67071	318
63858	235	63970	237	64520	266	66010Z	419	66175	421	66340Z	420	66565Z	419	66778	349	66901DH	423	66923	420	67012	319	67074	343
63859	235	63971	237	64530	266	66012	419	66178	421	66349	427	66565Z	223	66779	349	66901DZ	421	66923Z	420	67012	307	67075	318
63860	235	63972	237	64600	179	66012Z	419	66202	420	66350	427	66567Z	419	66780	276	66901P	422	66925	420	67013	319	67084	343
63861	235	63973	237	64601	179	66015	419	66202Z	420	66351	427	66599	426	66781	276	66901Z	421	66925Z	420	67013	307	67090	343
63862	235	63974	236	64602	179	66015Z	419	66202Z	223	66352	427	66610	420	66782	276	66902	421	66926	342	67014	319	67130	318
63863	234	63975	237	64603	179	66017	419	66210	420	66353	427	66610E	425	66783	276	66902D	421	66927	342	67014	307	67130	175
63864	235	63976	236	64604	179	66020	419	66210E	425	66355	420	66610H	423	66784	276	66902DH	423	66930	432	67015	323	67131	318
63865	234	64407	451	64605	179	66020Z	419	66210H	423	66355Z	420	66610J	424	66785	276	66902DZ	421	66931	433	67016	319	67133	318
63871	404	64407	261	64606	179	66040	419	66210J	424	66365	420	66610P	422	66787	276	66902P	422	66932	433	67016	307	67134	161
63872	404	64408	451	64607	179	66040Z	419	66210P	422	66365E	425	66610Z	420	66788	276	66902Z	421	66933	432	67017	319	67140	330
63873	404	64408	261	64608	179	66042	419	66210Z	420	66365H	423	66615	420	66794	350	66903	421	66933C	432	67017	307	67142	330
63874	404	64409	451	64609	179	66064	426	66210Z	223	66365J	424	66615H	423	66796	350	66903D	421	66934	432	67018	319	67143	330
63880	404	64409	261	64610	180	66065	419	66212	420	66365P	422	66615P	422	66799	350	66903DH	423	66934C	432	67018	307	67148	330
63881	404	64418	325	64611	180	66065Z	419	66215	420	66365Z	420	66615Z	420	66800	347	66903DZ	421	66935	433	67019	319	67149	330
63882	404	64422	325	64612	180	66066	426	66215H	423	66402	420	66620	420	66801	347	66903P	422	66936	433	67019	307	67150	336
63889	404	64424	327	64613	180	66067	419	66215P	422	66402Z	420	66620Z	420	66802	347	66903Z	421	66936C	433	67020	319	67151	150
63894	404	64426	327	64614	180	66067Z	419	66215Z	420	66410	420	66642	428	66804	348	66904	421	66936T	433	67020	307	67153	343
63911	201	64427	327	64615	180	66099	426	66215Z	223	66410E	425	66665	420	66805	348	66904D	421	66937	432	67021	319	67156	330
63912	161	64428	327	64616	180	66102	419	66217	420	66410H	423	66665E	425	66807	347	66904DH	423	66937C	432	67021	307	67158	343
63914	161	64429	327	64617	180	66102Z	419	66220	420	66410J	424	66665H	423	66808	348	66904DZ	421	66938	432	67022	319	67163	343
63915	161	64430	325	64618	180	66104	419	66220H	423	66410P	422	66665J	424	66816	347	66904P	422	66938	432	67022	307	67210	318
63926	270	64431	325	64619	180	66110	419	66220P	422	66410Z	420	66665P	422	66817	347	66904Z	421	66939	432	67023	319	67211	318
63928	88	64432	270	64620	181	66110E	425	66220Z	420	66415	420	66665Z	420	66819	347	66905	421	66940	432	67023	307	67212	318
63928	109	64433	270	64621	163	66110H	423	66220Z	223	66415H	423	66731	350	66820	347	66905D	421	66942	432	67025	323	67213	318
63929	270	64434	270	64622	180	66110J	424	66222	420	66415P	422	66732	350	66822	348	66905DZ	421	66945	433	67026	336	67214	318
63932	88	64435	325	64623	180	66110P	422	66240	420	66415Z	420	66733	348	66824	348	66905Z	421	66945S	433	67027	143	67215	318
63932	109	64436	270	64624	163	66110Z	419	66240Z	420	66420	420	66734	348	66825	348	66906D	421	66945T	433	67028	143	67410	126
63936	88	64437	270	64625	163	66112	419	66240Z	223	66420Z	420	66735	349	66826	348	66906DH	423	66947	433	67029	324	67412	126
63936	109	64439	270	64626	163	66112Z	419	66242	420	66465	420	66736	348	66831	276	66906DZ	421	66948	432	67030	342	67414	318
63939	270	64440	325	64627	163	66115	419	66245	418	66465E	425	66737	349	66834	276	66906P	422	66948S	432	67030	239	67415	126
63940	88	64441	325	64815	266	66115H	423	66246	418	66465H	423	66738	349	66839	275	66907	421	66950	433	67031	201	67417	126
63940	109	64444	325	64820	266	66115P	422	66247	428	66465J	424	66742	348	66840	275	66907P	312	66951	430	67032	201	67420	126
63941	236	64445	326	64830	266	66115Z	419	66249	427	66465P	422	66745	350	66841	275	66908DZ	421	66952	430	67034	503	67421	327
63942	236	64446	326	65012	290	66116	428	66255Z	420	66465Z	420	66746	487	66842	275	66908P	421	66953	430	67034	452	67427	327
63943	236	64450	325	65025	290	66117	419	66255Z	223	66502	419	66747	345	66845	275	66909	421	66957	430	67036	319	67433	327
63944	236	64451	327	65035	290	66117Z	419	66265	420	66502Z	419	66748	346	66846	275	66909D	421	66957Z	430	67037	319	67434	327
63945	236	64452	327	65044	325	66118	428	66265E	425	66502Z	223	66749	350	66847	275	66909DH	423	66960	430	67038	343	67435	327
63946	237	64453	327	65050	325	66120	419	66265H	423	66510	419	66752	277	66848	371	66909DZ	421	66961	430	67039	343	67604	420
63947	237	64454	327	65060	290	66120H	423	66265J	424	66510Z	419	66753	350	66858	370	66909P	422	66962	430	67041	324	67604Z	420
63948	237	64455	327	65110	290	66120P	422	66															

Ref.	Pag.	Ref.	Pag.	Ref.	Pag.	Ref.	Pag.	Ref.	Pag.	Ref.	Pag.	Ref.	Pag.	Ref.	Pag.	Ref.	Pag.	Ref.	Pag.	Ref.	Pag.	Ref.	Pag.
67828	353	68054	323	68240	358	68460	358	68591	359	68740	351	68930	338	69028	392	69110	389	69223	487	69296	406	69371	498
67832	353	68057	323	68246	331	68461	355	68597	359	68741	351	68932	339	69029	260	69111	466	69225	447	69297	524	69373	535
67836	353	68058	323	68247	331	68462	355	68598	359	68760	349	68934	339	69030	393	69115	486	69226	447	69297	293	69374	467
67901	421	68060	352	68248	352	68463	355	68601	308	68770	349	68935	338	69032	399	69115	462	69227	504	69298	523	69379	503
67901Z	421	68061	352	68250	323	68464	355	68602	308	68780	355	68936	356	69033	399	69116	540	69230	483	69298	292	69380	535
67902	421	68069	332	68252	323	68465	230	68604	337	68781	355	68937	338	69034	389	69118	483	69231	533	69299	463	69382	536
67902Z	421	68070	332	68253	323	68465	115	68605	337	68782	355	68939	338	69036	516	69120	533	69232	500	69300	556	69384	467
67903	421	68078	269	68254	323	68466	230	68607	358	68783	355	68940	338	69037	315	69121	486	69232	500	69302	547	69385	526
67903Z	421	68079	269	68270	129	68466	115	68608	358	68784	355	68941	335	69038	513	69122	510	69233	456	69303	547	69386	537
67904	421	68080	153	68271	129	68470	355	68609	358	68785	355	68942	339	69039	513	69123	487	69234	448	69304	547	69387	537
67904Z	421	68082	153	68272	129	68471	355	68610	358	68786	355	68945	338	69041	291	69125	483	69235	447	69306	462	69388	464
67905	421	68085	150	68273	129	68472	355	68612	358	68787	355	68947	335	69042	544	69130	483	69236	447	69310	555	69389	536
67905Z	421	68085	150	68274	129	68473	355	68614	358	68788	355	68948	339	69045	542	69131	388	69237	447	69312	497	69396	530
67906	421	68090	324	68275	129	68480	358	68616	358	68789	355	68950	338	69046	544	69132	408	69238	551	69313	555	69396	284
67906Z	421	68091	332	68276	129	68482	359	68618	358	68790	355	68954	338	69047	544	69134	490	69239	551	69314	554	69397	523
67909	421	68092	332	68280	133	68488	359	68619	292	68791	355	68955	338	69048	544	69135	490	69240	447	69317	511	69397	293
67909Z	421	68099	332	68281	133	68492	359	68620	358	68792	355	68959	262	69050	542	69136	232	69241	448	69317	341	69398	530
67910	401	68101	157	68282	133	68498	359	68622	358	68793	355	68960	338	69051	544	69138	410	69242	516	69318	511	69398	284
67911	401	68102	157	68283	133	68500	337	68624	358	68794	355	68964	338	69052	544	69139	386	69243	461	69319	511	69399	512
67914	400	68107	359	68284	133	68501	337	68626	358	68795	355	68965	338	69053	544	69140	232	69244	460	69320	554	69399	263
67916	400	68120	359	68285	153	68502	337	68627	292	68796	355	68966	262	69054	544	69141	559	69245	460	69321	171	69400	568
67918	400	68121	359	68300	337	68506	358	68628	358	68797	355	68967	262	69055	544	69141	221	69246	461	69322	499	69401	568
67920	401	68132	324	68301	337	68508	358	68629	292	68798	355	68968	335	69056	544	69145	410	69247	508	69323	499	69410	565
67921	401	68136	324	68305	198	68509	358	68639	292	68799	355	68969	334	69057	544	69146	232	69248	448	69324	499	69411	565
67924	400	68137	324	68306	198	68510	358	68640	351	68801	331	68970	338	69058	544	69147	508	69249	448	69325	499	69414	565
67926	400	68141	330	68307	198	68511	342	68641	351	68802	331	68971	338	69059	544	69148	508	69250	447	69327	497	69420	566
67928	400	68142	330	68308	358	68512	358	68642	351	68803	331	68972	338	69061	412	69149	509	69251	447	69329	499	69421	566
67934	400	68150	330	68310	358	68513	342	68643	292	68804	331	68973	338	69062	531	69151	542	69256	529	69330	499	69422	566
67938	400	68151	330	68340	323	68514	358	68644	292	68805	342	68974	335	69064	531	69152	232	69256	285	69332	399	69423	566
67944	400	68153	330	68341	323	68516	358	68651	509	68806	194	68976	262	69065	530	69156	232	69259	544	69333	399	69424	567
67948	400	68154	330	68342	323	68518	358	68651	335	68808	353	68977	262	69065	406	69163	531	69260	531	69334	459	69425	567
67951	401	68161	330	68350	323	68520	358	68652	509	68810	353	68978	262	69066	530	69165	232	69261	559	69336	514	69426	567
67952	401	68173	132	68351	323	68522	358	68652	335	68814	353	68979	262	69066	406	69166	507	69261	221	69336	391	69427	567
68000	356	68174	132	68354	323	68524	358	68659	351	68818	353	68980	339	69068	482	69167	507	69263	516	69337	498	69428	529
68001	352	68175	132	68357	323	68526	358	68660	351	68821	353	68981	334	69070	553	69168	232	69264	516	69338	537	69428	286
68002	352	68176	132	68402	337	68527	332	68661	291	68822	353	68982	334	69073	481	69169	489	69266	517	69340	554	69429	528
68003	352	68177	132	68402	170	68532	359	68662	291	68823	353	68983	334	69075	553	69170	490	69267	517	69341	559	69429	285
68004	352	68178	132	68403	337	68536	359	68663	291	68824	353	68984	335	69077	481	69172	530	69272	527	69341	221	69431	555
68005	153	68179	132	68403	170	68537	359	68664	291	68825	353	68985	339	69079	485	69172	406	69273	527	69343	457	69432	557
68006	153	68180	198	68404	337	68538	359	68666	291	68827	353	68987	262	69081	539	69173	530	69274	527	69344	457	69433	510
68007	261	68181	161	68405	337	68540	359	68667	291	68828	353	68988	334	69084	464	69173	406	69275	527	69345	461	69435	528
68007	231	68182	161	68406	358	68544	359	68668	291	68829	353	68989	340	69087	385	69179	503	69276	523	69346	456	69435	286
68008	342	68185	133	68407	358	68546	359	68676	354	68831	353	68991	339	69088	386	69192	547	69276	293	69347	497	69438	460
68008	269	68186	133	68408	358	68547	359	68680	354	68832	353	68992	339	69089	384	69193	548	69277	524	69348	505	69439	460
68009	268	68187	133	68410	358	68548	359	68684	354	68833	353	68993	339	69091	384	69195	538	69277	293	69349	509	69440	531
68010	356	68188	133	68411	358	68550	359	68686	354	68835	353	68994	339	69092	385	69196	510	69278	527	69352	540	69441	456
68017	261	68189	133	68412	358	68552	359	68688	354	68836	353	68996	339	69093	386	69197	503	69279	526	69353	541	69442	531
68017	231	68195	133	68414	358	68554	359	68696	354	68842	353	68997	339	69094	386	69202	448	69280	533	69354	543	69444	531
68021	268	68196	133	68416	358	68556	359	68714	356	68862	353	68998	339	69095	385	69203	448	69282	527	69355	543	69445	515
68023	323	68197	193	68418	358	68557	359	68716	356	68863	353	68999	339	69096	388	69204	448	69283	532	69356	542	69446	515
68024	323	68197	133	68420	358	68558	359	68718	356	68882	353	69002	514	69097	388	69205	448	69285	533	69357	542	69447	491
68026	323	68198	193	68422	358	68560	359	68720	261	68892	339	69002	389	69098	387	69207	448	69286	532	69358	543	69448	491
68030	352	68198	133	68424	358	68566	359	68720	231	68893	339	69006	389	69099	384	69208	448	69287	533	69359	517	69450	513
68031	352	68199	133	68441	358	68567	359	68723	353	68898	334	69012	514	69100	387	69211	448	69288	534	69360	531	69450	333
68040	352	68200	359	68450	354	68568	359	68724	353	68899	334	69012	389	69101	388	69212	448	69291	524	69361	516	69451	544
68041	352	68																					

Ref.	Pag.	Ref.	Pag.	Ref.	Pag.	Ref.	Pag.	Ref.	Pag.	Ref.	Pag.	Ref.	Pag.	Ref.	Pag.	Ref.	Pag.	Ref.	Pag.	Ref.	Pag.
69460	544	69565	517	69751	472	71326	102	72807	127	80628	52	88124	50	90622	47	R27520A	59				
69461	544	69566	517	69761	470	71328	102	72808	127	80714	52	88125	51	90624	47	R27520A	120				
69462	544	69567	173	69762	470	71711	263	72809	127	80716	52	88126	50	90626	47	R27528A	59				
69463	544	69568	173	69763	470	71780	389	72810	127	80718	52	88128	50	90628	47	R27528A	120				
69464	544	69570	504	69764	470	71780	263	72811	127	80916	52	88129	51	90632	47	R27732A	59				
69465	488	69572	506	69765	470	71784	76	72850	127	80918	52	88132	50	90712	47	R27732A	120				
69466	489	69573	506	69771	470	71786	76	72851	127	80920	52	88212	51	90714	47	R39042A	273				
69468	489	69574	507	69772	470	71788	76	72853	127	80922	52	88214	51	90716	47	R39135C	561				
69469	489	69575	533	69773	470	71818	102	72854	127	80924	52	88216	51	90718	47	R60226A	158				
69471	525	69576	517	69774	470	71820	102	72855	127	80926	52	88218	51	90916	47	R60227A	158				
69471	392	69579	485	69775	470	71822	102	72856	127	80928	52	88220	51	90918	47	R60258A	159				
69472	525	69581	539	69781	471	71824	102	72857	127	85003	49	88318	51	90920	47	R60259A	159				
69472	392	69583	465	69782	471	71826	102	72858	127	85016	48	88324	51	90922	47	R60594A	223				
69476	525	69584	465	69783	471	71828	102	72859	127	85018	48	88420	51	90924	47	R61668C	480				
69476	392	69587	539	69784	471	71862	78	72916	41	85020	48	88424	51	90926	47	R61668D	480				
69481	525	69590	522	69785	471	71864	78	72920	41	85022	48	88620	51	90928	47	R61671A	478				
69481	393	69590	524	69791	471	71866	78	72924	41	85024	48	88622	51	90932	47	R61672D	476				
69486	525	69591	524	69792	471	71868	78	72928	41	85026	48	88624	51	91520	449	R61678K	478				
69486	393	69592	546	69793	471	71871	74	72932	41	85028	48	88626	51	91521	449	R61678L	478				
69488	534	69601	313	69794	471	71872	74	79016	43	85118	48	88628	51	91525	449	R61679AA	479				
69490	481	69602	314	69795	471	71874	74	79020	43	85120	48	88632	51	91530	453	R61679AB	479				
69492	548	69603	314	69801	472	71875	74	79024	43	85122	48	88712	51	91533	453	R61682A	479				
69500	484	69604	313	69801	469	71876	74	79028	43	85124	48	88714	51	91540	449	R61682B	479				
69503	484	69605	315	69803	472	71878	74	79116	43	85125	49	88716	51	91541	449	R63033	312				
69504	484	69606	315	69803	469	71884	77	79120	43	85126	48	88718	51	91542	449	R63051A	312				
69505	484	69607	314	69815	469	71886	77	79124	43	85128	48	88916	51	98803	131	R63331A	453				
69506	484	69615	512	69816	469	71887	77	79128	43	85129	49	88918	51	98804	131	R63332A	453				
69507	484	69617	511	69820	472	71901	75	79214	43	85212	49	88920	51	98806	131	R66957A	430				
69508	493	69617	341	69824	472	71904	75	79216	43	85214	49	88922	51	98807	131	R69018	392				
69509	496	69632	498	69825	472	71906	75	79218	43	85216	49	88924	51	98808	131	R69018	392				
69510	484	69633	498	69830	472	71908	75	79220	43	85218	49	88926	51	98810	131	R69027	392				
69511	495	69670	550	69840	472	71914	90	79420	43	85220	49	88928	51	98811	131	R69061A	516				
69512	484	69671	550	69850	472	71916	90	79424	43	85420	49	88932	51	98903	130	R69094A	386				
69513	492	69672	550	69905	474	71918	90	79624	43	85424	49	90016	46	98904	130	R69099B	385				
69514	484	69673	550	69906	474	71920	90	79628	43	85624	49	90018	46	98905	130	R69099C	385				
69515	494	69675	553	69907	474	71922	90	79714	43	85625	49	90020	46	98906	130	R69100A	387				
69518	484	69680	390	69916	475	71924	90	79830	43	85629	49	90022	46	98907	130	R69195B	538				
69520	532	69681	390	69918	475	71926	90	79916	43	85712	49	90024	46	98908	130	R69195N	538				
69521	171	69682	390	69920	473	71928	90	79920	43	85714	49	90026	46	98909	130	R69295A	538				
69523	487	69683	465	69925	475	71932	90	79924	43	85716	49	90028	46	98910	130	R69295B	538				
69524	487	69684	465	69926	475	72016	41	79928	43	85718	49	90032	46	98911	130	R69295D	538				
69530	541	69685	465	69929	473	72020	41	80016	52	85916	49	90116	46	98912	130	R69346F	456				
69531	541	69690	162	69930	475	72024	41	80018	52	85918	49	90118	46	98913	130	R69400B	568				
69540	541	69691	162	69932	474	72028	41	80020	52	85920	49	90120	46	98914	130	R69400N	568				
69541	541	69692	162	69933	474	72032	41	80022	52	85922	49	90122	46	R25436A	93	R69400R	568				
69543	458	69693	162	69934	474	72116	41	80024	52	85924	49	90124	46	R25436A	120	R69722J	469				
69547	458	69694	162	69935	474	72120	41	80026	52	85926	49	90125	47	R25436A	108	R69735J	472				
69550	173	69695	162	69940	475	72124	41	80028	52	85928	49	90126	46	R25536A	93	R91533A	453				
69551	173	69696	162	69946	475	72125	41	80116	52	88016	50	90128	46	R25536A	120						
69552	173	69697	162	69950	475	72128	41	80118	52	88018	50	90129	47	R25547A	93						
69553	173	69698	162	69955	475	72129	41	80120	52	88020	50	90132	46	R25547A	120						
69554	172	69699	162	69966	475	72214	41	80122	52	88022	50	90212	47	R25736A	93						
69555	173	69700	551	69976	474	72216	41	80124	52	88024	50	90214	47	R25736A	120						
69556	173	69701	551	69977	474	72218	41	80126	52	88026	50	90216	47	R25747A	93						
69557	173	69702	551	69978	474	72220	41	80128	52	88028	50	90218	47	R25747A	120						
69558	173	69703	551	69979	474	72714	41	80212	52	88032	50	90220	47	R25917G	63						
69559	173	69722	469	69986	475	72716	41	80214	52	88116	50	90318	47	R25917G	120						
69560	173	69723	469	71318	102	72803	127	80216	52	88118	50	90324	47	R25933G	63						
69562	516	69735	472	71320	102	72804	127	80218	52	88120	50	90420	47	R25933G	120						
69563	516	69736	472	71322	102	72805	127	80624	52	88121	51	90424	47	R25935G	63						
69564	517	69750	472	71324	102	72806	127	80626	52	88122	50	90620	47	R25935G	120						

# Índice alfabético

Sommaire alphabétique

Alphabetisch Index

Alphabetical Index

Indice alfabético

## ES Índice alfabético

### A

ABLANDACARNE	160
ABRE OSTRAS	192, 272
ACEITERA	264
AERÓGRAFO	333, 511
AFILADOR CUCHILLOS	220, 221, 557
AGUJA DE MECHAR	167
AHUMADOR	171
AIREADOR DE VINO	309
AIRPOT	392, 523
ANILLA ANTI-GOTEO	309
ARMARIO ESTERILIZADOR	548, 558
ARMARIO REFRIGERADOR	549, 551
ARO	352, 358, 359
ARO PERFORADO	359
ASA / MANGO DESMONTABLE	35, 102
ASA DE SILICONA	59, 120
ASADOR	88
ASADOR DE SALCHICHAS	456
ATRILPORTA MENÚ	363
AZUCARERO	260, 290

### B

BANDEJA	113, 242, 253, 430, 431
BANDEJA / FUENTE	230, 231, 232, 234, 235, 236, 237, 239, 240, 243, 253, 261
BANDEJA CAMARERO	231, 232
BANDEJA HORNO	32, 355
BANDEJA ISOTÉRMICA	426, 432
BAÑO MARIA	26, 28, 341, 509, 514
BARRA SUJECCIÓN NOTAS	136
BÁSCULA	182, 183, 184, 185, 186, 187, 319, 555
BATIDOR	291, 465, 471, 472, 473, 475
BATIDORA	462, 463, 464, 465, 467, 468, 469, 470, 474, 476, 477, 478, 533, 534, 535, 536, 537
BIBERÓN DECORACIÓN	340
BOBINA FILM	452
BOBINA VACÍO	542
BOL	176, 177, 235, 237, 239, 240, 253, 259, 320, 321
BOLAS AISLANTES SOUS VIDE	547
BOLSAS VACÍO	542
BOMBA VACÍO	312
BOQUILLA SERVIDORA	309
BOQUILLAS	339
BOTELLA BIBERÓN	340
BOTELLA DOSIFICADORA	64, 249
BOTELLA PERSONAL	282
BOTES ORGANIZADORES	163
BOTES VACÍO	542

### C

CACEROLA	20, 23, 27, 29, 30, 35, 37, 38, 41, 43, 44, 46, 48, 50, 52, 53, 54, 56, 57, 59, 61, 65, 395
CACEROLA ALTA	21, 24, 27, 29, 30
CACEROLA BAJA	37, 56, 57
CACEROLA OVAL	62, 63, 66, 69
CACEROLA VAPOR	25, 43, 44, 47, 49, 51, 55, 152
CACILLO	135
CACILLO SALSA	142
CADENA	352
CAFETERA	285, 286, 287, 288, 289, 290, 526, 527
CAFETERA GOTEO	524, 525

CAFETERA PERCOLADORA	393, 523
CALDERO	178, 322
CALENTADOR	514, 563, 564, 565, 566
CALENTADOR CHAFING	389, 512
CAMPANA	260, 399
CAMPANA AHUMADOR	172
CAMPANILLA	261
CARRO SERVICIO	427, 428, 433
CASCANUECES	272
CATERING	397
CAZO BOMBADO	31
CAZO CÓNICO	22, 26
CAZO FRANCÉS	22, 26
CAZO RECTO	22, 25, 28, 29, 31, 35, 37, 38, 41, 43, 45, 47, 49, 51, 52, 53, 54, 55, 57, 59, 61, 63, 64, 88, 178, 249

CAZO RECTO ALTO	22, 25, 28, 31
CEDAZO	323
CENTRIFUGADORA	166
CEPILLO PARA TABLA CORTE	225
CEPILLO RECOGEDOR	261, 451
CESTA	447, 448
CESTILLO	152, 255
CHAFING DISH	385, 386, 387, 388, 389, 390, 391, 512
CHAIRA	213, 215
CHOCOLATERA	510
COCEDOR AL VAPOR	484
COCEDOR DE HUEVOS	455
COCEDOR DE SALCHICHAS	456
COCTELERA	307
COLADOR	45, 47, 51, 55, 146, 147, 308
CONTENEDOR ALIMENTOS	163
CONTENEDOR CUBIERTOS	136
COPA	343
CORDEL COCINA	117
CORDÓN DE CUERO	367
CORTA VEGETALES	460, 482, 484
CORTADOR	191, 192, 194, 197, 198, 199, 481
CORTADOR PATATAS	198
CORTADORA FIAMBRE	481
CORTAPASTAS	331
CORTAPIZZA	143
CORTATARTAS	332
CREPERA	39, 85, 89, 93, 95, 97, 103, 508
CUBERTERO	226, 227
CUBETA	395, 418, 419, 420, 422, 423, 425

CUBETA PERFORADA	419, 420
CUBIERTOS	226
CUBITERA	296, 307
CUBO	178
CUBO ENFRIABOTELLAS	299, 300
CUBRE QUESO/TARTA	260
CUBREPLATOS	260, 399, 433
CUCHARA APOYA UTENSILIOS	136
CUCHARA LISA	240
CUCHARA MIEL	272
CUCHILLO	134, 191, 192, 193, 208, 209, 210, 211, 212, 214, 215, 216
CUECE ESPECIAS	152
CUECEPASTAS	44
CUSCUSERA	55

### D

DELANTAL	121, 122
DESCÁPSULADOR	309

# ES Índice alfabético

DESCORAZONADOR	192, 193, 198
DESESCAMADOR DE PESCADO	273
DESHIDRATADOR	485
DESHOJADOR DE HIERVAS	198
DISPENSADOR	265, 393, 394
DISPENSADOR JABÓN	449
DOBLE FONDO	421, 422, 423
DOSIFICADOR	150
DOSIFICADOR LICOR	308

## E

EMBUDO	150
EMBUTIDORA MANUAL	165
ENCENDEDOR	262
ENSALADERA	259
ESCURREFRITOS	149
ESCURREPLATOS	452
ESCURRIDERA	45, 47, 51, 55, 148, 149
ESPÁTULA	134, 135, 138, 139, 326, 342
ESPÁTULA LISA	138, 139, 192
ESPÁTULA PIZZA	142
ESPECIERO	265
ESPUMADERA	126
ESPUMADOR DE LECHE	284, 528
ESTANTE TUBULAR	428
ESTANTERIA	436, 437, 438, 439, 440, 441, 442, 443, 444
ESTECAS	324
EXPOSITOR	396
EXPRIMIDOR	161, 530, 531, 533

## F

FLANERO	350, 352, 353
FONDUE	263, 510
FREIDORA	487, 488, 489, 490, 491, 492, 493, 494
FRUTEROS	256
FUENTE CHOCOLATE	511
FUENTE HONDA	178, 322
FUENTE PARA MANTEQUILLA	259
FUNDA CARRO	428
FUNDA ENFRIABOTELLAS	295

## G

GARRAS DE OSO	154, 196
GEL COMBUSTIBLE	263, 389
GOFRERA	507
GRILL	57, 59, 91, 95, 97
GUANTE	118, 119
GUIA DIVIDORA	420

## H

HARINERO	149
HERVIDOR	152
HERVIDOR AGUA	292, 293, 521, 522
HERVIDOR PESCADO	32
HORNO	495, 496, 497

## I

INDICADOR RESERVADO	260
---------------------	-----

## J

JAMONERO	205
JARRA DE AGUA	302, 433
JARRA SEPARADOR GRASA	264
JARRA TERMO	279, 280
JUEGO DE UTENSILIOS DE COCTELERÍA	305
JUEGO SALERO-PIMENTERO	264
JUEGO VINAGRERAS	264

## L

LÁMINA	485
LAMINADOR	164, 194, 199
LÁMPARA CALENTAMIENTO	516, 517
LECHERA	290, 292
LEGUNBRERA	259
LIBRADOR	307, 319
LICUADORA	532
LLAUNAS ARROZ	113

## M

MACHETE	213
MALETA CUCHILLOS	213
MALETÍN BBQ	134
MANDOLINA	202, 203
MANGA REPOSTERÍA	338
MANO CHINO	147
MANO MORTERO	155
MANOPLA	63, 120
MANTEL INDIVIDUAL	275, 276
MÁQUINA CUBITOS HIELO	552
MÁQUINA DE HELADO	460, 552
MÁQUINA ENFRIACOPAS	554
MÁQUINA VACÍO	162, 538, 539, 540, 541
MARCADOR TARTA	342
MARTILLO	160
MATAMOSQUITOS	559, 560, 561
MAZA	160, 308
MEDIDOR	175, 176, 318, 321
MEDIDOR PASTA	164
MELAMINA	241, 242, 244, 246, 254, 399
MICROONDAS	497
MINI GRILL	504
MINI-CUBO	255
MOLDE BAGUETTE	354
MOLDE EMPANADILLAS	157
MOLDE HUEVO	153
MOLDE PIZZA	142, 353
MOLDE REPOSTERÍA	345, 346, 347, 348, 349, 350, 352, 353, 355, 356, 358
MOLINILLO	266, 267, 284, 524
MORTERO	155

## N

NIDOS ALAMBRE	147
NÚMEROS MESA	260, 303

## O

OLLA	21, 24, 28, 29, 31, 38, 41, 43, 44, 46, 48, 50, 52, 53, 54, 61, 452, 501
------	--

# ES Índice alfabético

OLLA A PRESIÓN	71, 72, 73, 74, 75, 76, 77, 78
OLLA BAJA	21, 24
OLLA SUPER ALTA	41, 45, 47, 49, 51, 54
ORGANIZADOR ACCESORIOS CÓCTEL	306
ORGANIZADOR DE CAFÉ	393
ORGANIZADOR DE CUBIERTOS	226
ORGANIZADOR DE CUCHILLOS	226

## P

PAELLERA	22, 25, 28, 29, 31, 63, 65, 85, 88, 93, 106, 107, 108, 109, 110, 249
PAJITAS	353
PALA	139
PALA PARA PATATAS FRITAS	140
PALA PASTEL	192
PALA PIZZA	142, 143
PANERA	256
PAPELERA	261, 450
PARRILLA	421
PASAPURÉS	157
PEINE CARNE	199
PEINE DECORACIÓN	324
PELADOR	191, 192, 193, 194, 207
PICADORA	195, 479
PICADORA CARNE	480
PICADORA HIELO	307, 553
PIE PORTACUBOS	298
PINCEL	134
PINCHO MARISCO	273
PINCHO MARUNO	136
PINZA	134, 268, 269, 270, 271, 308, 342, 421
PINZAS	269
PIPETA PARA SALSA	167
PISTOLA GAS	334, 335
PISTOLA REPOSTERÍA	340
PIZARRA	232, 362, 364, 396, 556
PLACA CALENTAMIENTO	525
PLACA HORNO	116
PLACA INDUCCIÓN	498, 499
PLACA VITROCERÁMICA	500
PLANCHA GRILL	89, 93, 94, 501, 502
PLANCHA-GRILL	502, 505
PLATO	235, 237, 243, 432, 433
PLATO DE HUEVOS	231
PORTA COMANDAS	373, 374
PORTA FACTURAS	371, 373, 374
PORTA MENÚ	364, 367, 370, 371, 372, 373, 374, 375, 376, 377, 378, 379, 380, 381, 382

PORTAPLATOS	429
PORTARROLLOS	451, 452
PORTATARTA	342
POSABOTELLAS	231
POSAVASOS	231
POSTE SEPARADOR	453
POTE CILINDRICO	31, 41, 43, 45, 47, 49, 51, 52, 55
PRENSA AJOS	156, 192, 201
PRENSA HAMBURGUESAS	159
PRENSA PATATAS	156
PULVERIZADOR	264

## Q

QUEMADOR	335, 507
QUESERA	224, 260

## R

RACIONADOR HELADO	343
RALLADOR	200, 201
RASERA	126, 200
RASQUETA	324
RECIPIENTES INOX	179, 180, 181
RECLETTE	503
REFRIGERADOR	551
REJILLA PARA SOUS VIDE	547
REJILLA REPOSTERÍA	342
RELOJ COCINA	123
RIBETEADOR DE COPAS Y VASOS	306
ROBOT MULTIFUNCIÓN	225, 483
RODILLO	330
ROTULADORES PIZARRA	362, 556
RUSTIDERA	26, 32, 112, 114, 115

## S

SACACORCHOS	310, 311, 550
SALAMANDRA	501
SALSERA	259
SALVAMANTELES	277
SARTÉN	35, 37, 39, 45, 49, 57, 59, 61, 65, 80, 81, 82, 83, 84, 85, 87, 88, 90, 91, 92, 94, 95, 96, 97, 98, 99, 100, 101, 102, 103, 104, 249
SAUTEX	22, 25, 28, 49
SELLOS PARA GALLETAS	332
SEPARADOR CLARAS	153
SERVILLETERO	261, 452
SET UTENSILIOS	131
SIFÓN	170, 337
SIFÓN AGUA	308
SOPERA	259
SOPORTE BATIDORA BRISK	467, 470
SOPORTE COPAS	304
SOPORTE CUBIERTOS	227
SOPORTE MAGNÉTICO	219
SOPORTE MENU	260
SOPORTE MESA ENFRIABOTELLAS	298
SOPORTE PAELLERA	110
SOPORTE PAELLERA GAS BUTANO	110
SOPORTE PARA BANDEJAS	231
SOPORTE PARA HUEVO	153
SOPORTE PARA ROLLO	539
SOUS VIDE	544, 545, 546
SUJETA MANTELES	260

## T

TABLA DE CORTE	205, 222, 223, 224, 225
TABLA SERVIR	247, 253
TABLA SERVIR	
TABLA SERVIR	
TABLA SERVIR	254
TACO CUCHILLO	213, 218
TAPA	22, 26, 28, 29, 32, 35, 37, 39, 41, 43, 45, 47, 49, 51, 52, 55, 57, 59, 61, 90, 115, 395
TAPA PARA CUBETA	421, 422, 423
TAPETE	117, 350

# ES Índice alfabético

TAPETE COCTELERÍA	305
TAPÓN	309
TARTERA	38, 43, 45, 47, 51, 52, 55, 59, 61
TAZA	433
TAZAS COCTELERÍA	306
TENAZA MARISCO	272
TENEDOR	134, 212, 214
TERMO	280, 281, 282
TERMÓMETRO	188, 189
TERMOTRANS	426
TETERA	290, 291
TIJERAS	217
TOSTADORA	406, 528, 529
TRIANGULO	147
TRITURADOR MANUAL DE TOMATE	199

## V

VASO	282, 306, 433
VITRINA EXPOSITORA	312, 313, 314, 315

## W

WOK	39, 43, 85, 86, 89, 93, 95, 97, 100, 103
-----	--

## Y

YOGURTERA	458, 459
-----------	----------

# FR Index alphabétique

## A

AÉRATEUR DE VIN	309
AÉROGRAPHE	333, 511
AFÛTEUSE DE COUTEAUX	220, 221, 557
AIGUILLE À LARDER	167
AIRPOT	392, 523
ALLUME-GAZ	262
AMOVIBLE POIGNÉE / ANSE	35, 102
ANNEAU STOP GOUTTLES À VIN	309
APPAREIL ANTI-MOUSTIQUES	559, 560, 561
ARAIGNEE	126, 200
ARDOISE	232, 362, 364, 396, 556
ARMOIRE À STÉRILISER	548, 558
ASSIETTE	235, 237, 243, 432, 433
ATTENDRISEUR À VIANDE	160

## B

BAC	395, 418, 419, 420, 422, 423, 425
BAC PERFORE	419, 420
BAHUT	26, 28, 341, 509, 514
BAIN MARIE	385, 386, 387, 388, 389, 390, 391, 512
BALANCE	182, 183, 184, 185, 186, 187, 319, 555
BARRE À NOTES	136
BASSINE	178, 322
BASSINE PÂTISSIERE	178, 322
BATTEUR	462, 463, 464, 465, 467, 468, 469, 470, 474, 476, 477, 478, 533, 534, 535, 536, 537
BEC VERSEUR	309
BEURRIER AVEC COUVERCLE	259
BIBERON À DECORER	340
BILLES ISOLANTES SOUS VIDE	547
BLOC COUTEAU	213, 218
BOBINE DE CONSERVATION	542
BOÎTE À CONDIMENTS	163
BOITE À FROMAGE	224, 260
BOÎTES DE CONSERVATION	542
BOL	176, 177, 235, 237, 239, 240, 253, 259, 320, 321
BOUCHON	312
BOUILLORE	292, 293, 521, 522
BOUEILLE BIBERON	340
BOUEILLE DOSEUSE	64, 249
BRAISIERE	21, 24, 27, 29, 30
BROCHETTE	136
BROSSE POUR PLANCHE	225
BROYEUR À GLAÇONS	307, 553

## C

CAFETIÈRE	285, 286, 287, 288, 289, 290, 526, 527
CAFETIÈRE FILTRE	524, 525
CASIER	447, 448
CASSE NOIX	272
CASSEROLE	22, 25, 28, 29, 31, 35, 37, 38, 41, 43, 45, 47, 49, 51, 52, 53, 54, 55, 57, 59, 61, 63, 64, 88, 178, 249
CASSEROLE BOMBÉE	31
CASSEROLE FRANÇAISE	22, 26
CASSEROLE HAUTE	22, 25, 28, 31
CERCLE	352, 358, 359
CERCLE PERFOREE	359
CHAÎRE	352
CHARIOT DE SERVICE	427, 428, 433
CHAUFFE	514, 563, 564, 565, 566
CHAUFFE-CHAFING	389, 512

CHOCOLATIÈRE	510
CISEAUX	217
CLOCHE	260, 399
CLOCHE À FUMER	172
CLOCHES	260, 399, 433
COCOTTE À PRESSION	71, 72, 73, 74, 75, 76, 77, 78
CONTENEURS INOX	179, 180, 181
CORBILLE À FRUITS	256
CORDON EN CUIR	367
COUPE	343
COUPE CAPSULE	309
COUPE PATE	324
COUPE-POMMES DE TERRE	198
COUPELLE	433
COUPER	191, 192, 194, 197, 198, 199, 481
COUPERET	213
COUSCOUSSIER	55
COUTEAU	134, 191, 192, 193, 208, 209, 210, 211, 212, 214, 215, 216
COUTEAU À HUITRES	192, 272
COUTELLERIE	226, 227
COUVERCLE	22, 26, 28, 29, 32, 35, 37, 39, 41, 43, 45, 47, 49, 51, 52, 55, 57, 59, 61, 90, 115, 395
COUVERCLE POUR BAC	421, 422, 423
COUVERT	226
COUVRE FROMAGE/GÂTEAU	260
CREMIERE	290, 292
CREPIÈRE	39, 85, 89, 93, 95, 97, 103, 508
CUILLÈRE À GLACE	343
CUILLERE À MIEL	272
CUILLÈRE RAMASSE USTENSILES	136
CUILLÈREE LISSE	240
CUISEUR À OEUFS	455
CUISEUR VAPEUR	484
CUIT-PÂTE	44
CURETTES À HOMARD	273

## D

DECOUPOIRS DIVERS	331
DEROULEUR	451, 452
DESHYDRATEUR	485
DESSOUS DE PLATS	277
DIFFUSEUR ÉPICES	152
DISTRIBUTEUR	265, 393, 394
DISTRIBUTEUR À SAVON	449
DISTRIBUTEUR DE SERVIETTES	261, 452
DOUBLE FOND	421, 422, 423
DOUILLES	339

## E

ECUMOIRE	126
EFFEUILLEUSE À HERBES	198
EMPORTE-PIÈCES À GÂTEAU	332
ENSEMBLE D'USTENSILES	131
ENSEMBLE D'USTENSILES POUR COCKTAILS	305
ENTONNOIR	150
ENTONNOIR À DECOR	150
ESSOREUSE	166
EXPOSANT	396

## F

FAITOUT	20, 23, 27, 29, 30, 35, 37, 38, 41, 43, 44, 46, 48, 50, 52,
---------	---



# FR Index alphabétique

	53, 54, 56, 57, 59, 61, 65, 395
FAITOUT BASSE	37, 56, 57
FAITOUT OVALE	62, 63, 66, 69
FER À CARAMELISER	335, 507
FEUILLES	485
FIL DE CUISINE	117
FONDUE	263, 510
FONTAINE CHOCOLAT	511
FOUET	291, 465, 471, 472, 473, 475
FOUR	495, 496, 497
FOURCHETTE	134, 212, 214
FRITEUSE	487, 488, 489, 490, 491, 492, 493, 494
FRUIT CENTRIFUGEUSE	532
FUMOIR	171
FUSIL	213, 215

## G

GANT	118, 119
GAUFRIER	507
GEL CHAUFFE	263, 389
GRATTOIR	273
GRIFFES À VIANDE	154, 196
GRILL	57, 59, 91, 95, 97
GRILL À SAUCISSES	456
GRILLE	421
GRILLE-PAIN	406, 528, 529
GUIDE DE DIVISION	420
GURIDON PÂTISIER	342

## H

HACHOIR	200, 201
HACHOIR LÉGUMES	460, 482, 484
HACHOIR POUR VIANDE	480
HOUSSE CHARIOT	428
HOUSSE REFROIDISSEMENT	295
HUILIER	264

## I

INDICATEUR RÉSEVÉE	260
--------------------	-----

## L

LAMPE DE CHAUFFAGE	516, 517
LEGUMIERE	259
LLAUNAS ARROZ	113
LOUCHE	135
LOUCHE SAUCE	142

## M

MACHINE À GIVRER LES VERRES	554
MACHINE À GLAÇONS	552
MACHINE À HOT-DOGS	456
MACHINE DE CRÈME GLACÉE	460, 552
MACHINE SOUS VIDE	162, 538, 539, 540, 541
MALLETTE BARBECUE	134
MANCHE EN SILICONE	59, 120
MANDOLINE	202, 203
MARMITE	21, 24, 28, 29, 31, 38, 41, 43, 44, 46, 48, 50, 52, 53, 54, 61, 452, 501
MARMITE BASSE	21, 24

MARMITE S. HAUTE	41, 45, 47, 49, 51, 54
MARQUEUR À GATEAUX	342
MARQUEURS TABLEAU	362, 556
MARTEAU	160
MÉLAMINE	241, 242, 244, 246, 254, 399
MELLETE DE CHEF	213
MESURE À COCKTAIL	308
MESUREUE POUR PÂTES	164
MESUREUR	175, 176, 318, 321
MICRO-ONDES	497
MINI GRILL	504
MINI-CUBE	255
MORTIER	155
MOUFLETTE	63, 120
MOULE À BAGUETTE	354
MOULE À CHAUSSONS	157
MOULE À FLAN	350, 352, 353
MOULE À OEUF	153
MOULE À PÂTISSERIE	345, 346, 347, 348, 349, 350, 352, 353, 355, 356, 358

MOULE À PIZZA	142, 353
MOULIN	266, 267, 284, 524
MOUSSEUR À LAIT	284, 528

## N

NAPPE INDIVIDUEL	275, 276
NUMÉROS DE TABLE	260, 303

## O

ORGANISATEUR DE CAFÉ	393
ORGANISATEUR DE COUTEAUX	226
ORGANISATEUR DE COUVERTS	226
ORGANISATEUR POUR ACCESSOIRES DE COCKTAIL	306
ORGANISER LES BOUTEILLES	163
OUTILS	324

## P

PALETTE À GÂTEAU	192
PANIER	152, 255
PANIER À COUVERTS	136
PANIER À NID	147
PANIER MARGUERITE	152
PANIER POUR COUVERT	226, 227
PANIER VAPEUR	25, 43, 44, 47, 49, 51, 55, 152
PANIERE	256
PASSOIRE	45, 47, 51, 55, 146, 147, 308
PASSOIRE A FRITURE	149
PASSOIRE SUR PIED	45, 47, 51, 55, 148, 149
PAT À OEUFS	231
PEIGNE À PATE	324
PEIGNE POUR VIANDE	199
PELLE	139
PELLE À FARINE	307, 319
PELLE A FRITES	140
PELLE PIZZA	142, 143
PERCOLATEUR À CAFÉ	393, 523
PERSONNELLE BOUTEILLE	282
PICHET THERMO	279, 280
PIED POUR RECHAUD	110
PILON	160, 308
PINCE À CASSE-HOMARD	272
PINCE À NAPPE	260

# FR Index alphabétique

PINCEAU	134, 268, 269, 270, 271, 308, 342, 421
PINCES	269
PISTOLET POUR PÂTISSERIE	340
PLANCHE À DÉCOUPER	205, 222, 223, 224, 225
PLAQUE À FOUR	32, 355
PLAQUE À GRILL	89, 93, 94, 501, 502
PLAQUE À INDUCTION	498, 499
PLAQUE POUR CHAUFFANTE	525
PLAQUE VITROCÉRAMIQUE	500
PLAT À ROTIR	26, 32, 112, 114, 115
PLAT ROND	38, 43, 45, 47, 51, 52, 55, 59, 61
PLATEAU	113, 242, 253, 430, 431
PLATEAU ISOTHERME	426, 432
PLATEAU LIMONADIER	231, 232
PO-CILINDRIQUE	31, 41, 43, 45, 47, 49, 51, 52, 55
POCHE À DECORER	338
POËLE	35, 37, 39, 45, 49, 57, 59, 61, 65, 80, 81, 82, 83, 84, 85, 87, 88, 90, 91, 92, 94, 95, 96, 97, 98, 99, 100, 101, 102, 103, 104, 249
POIRE À JUS	167
POISSONNIÈRE AVEC GRILLE	32
POMPE À VINE	312
PORTE-COMMANDES	373, 374
PORTE-FACTURES	371, 373, 374
PORTE-MENU	364, 367, 370, 371, 372, 373, 374, 375, 376, 377, 378, 379, 380, 381, 382

PORTE-PLAQUE	429
PORTE-ROULEAU	539
PORTE-SEAU	298
POT À EAU	302, 433
POTEAU SÉPARATEUR	453
POUBELLE	261, 450
POUSSOIR À CHINOIS	147
POUSSOIR À MORTIER	155
POUSSOIR MANUEL	165
PRESSE À HAMBURGUERS	159
PRESSE-AGRUMES	161, 530, 531, 533
PRESSE-PAIL	156, 192, 201
PRESSE-PUREE	157
PRESSE-TOMATES MANUEL	199
PULVÉRISATEUR	264
PUPITRE PORTE-MENU	363

## R

RACK POUR SOUS VIDE	547
RAMASSE-MIETTES	261, 451
RAYONNAGE	436, 437, 438, 439, 440, 441, 442, 443, 444
RECHAUD	110
RECLETTE	503
REFROIDISSEUR	551
REFROIDISSEUR À VIN	549, 551
RESTAURATION	397
ROBOT MULTIFONCTIONS	225, 483
RÔTISSOIRE	88
ROULEAU FILM	452
ROULEAU PATISIER	330
ROULETTE PIZZA	143

## S

SACS DE CONSERVATION	542
SALADIER	259
SALAMANDRE	501
SAUCIERE	259

SAUPOUDREUSE	265
SAUTASE CONIQUE	22, 26
SAUTEUSE	22, 25, 28, 49
SDESSOUS DE BOUTEILLE	231
SEAU	178
SEAU À GLACE	296, 307
SEAU À VIN	299, 300
SÉPARATEUR À OEUF	153
SEPARATEUR DE GRAISSE	264
SET CALIÈRE ET POIVERE	264
SET VINAIGRIE	264
SHAKER	307
SIPHON	170, 337
SIPHON À EAU	308
SONNETTE	261
SOUPIERE	259
SOUS VIDE	544, 545, 546
SOUS-VERRE	231
SPATULA	134, 135, 138, 139, 326, 342
SPATULE LISSE	138, 139, 192
SPATULE PIZZA	142
SUCREUR/SALEUR BORDEUR DE VERRES	306
SUCRIER	260, 290
SUPPORT À COUPES	304
SUPPORT D'OEUFS	153
SUPPORT MAGNETIQUE	219
SUPPORT MÉLANGEUR BRISK	467, 470
SUPPORT MENU	260
SUPPORT POUR JAMBON	205
SUPPORT POUR PLATEAUX	231
SUPPORT SEAU	298

## T

TABLE DE SERVICE	247, 253
TAMIS	323
TAMIS À FARINE	149
TAMPONS POUR BISCUITS	332
TAPIS	117, 350
TAPIS ÉGOUTTOIR	305
TASSES À COCKTAIL	306
THÉIÈRE	290, 291
THERMO	280, 281, 282
THERMOMETRE	188, 189
THERMOTRANS	426
TIRE-BOUCHON	310, 311, 550
TORCHE À CARAMELISER	334, 335
TRANCHEUSE DE CHARCUTERIE	481
TRIANGLE	147

## V

VERRE	282, 306, 433
VIDE-POMMES	192, 193, 198
VITRINI DE PRÉSENTATION	312, 313, 314, 315

## W

WOK	39, 43, 85, 86, 89, 93, 95, 97, 100, 103
-----	--

## Y

YAOURTIÈRE	458, 459
------------	----------

# DE Alphabetischer Index

## A

ABNEHMBAR STIELGRIFFE / SEITENGRIFFE	35, 102
ABTROPFMATTE	452
ABTROPFSCHÜSSEL	45, 47, 51, 55, 148, 149
ABTROPFSHÜSSEL FÜR FRITTIERTES	149
ADBECKUNG FÜR TELLERWAGEN	428
AIRBRUSH	333, 511
APFELENTKERNER	192, 193, 198
APPARAT ZUM RAUCHARN	171
AUSFSCHNITTMASCHINE	481
AUSGIESS-AUFSATZ	309
AUSSTELLER	396
AUSTERMESSER	192, 272

## B

BACKBLECH-AUFLAGE	117, 350
BACKSCHAUFEL	138, 139, 192
BAGUETTEFORM	354
BAIN MARIE	26, 28, 341, 509, 514
BESTECK	226
BESTECK-ORGANISATOR	226
BLACKBLECH	32, 355
BLÄTTER	485
BRATENTOPF	37, 56, 57
BRATPFANNE	26, 32, 112, 114, 115
BRENNER	335, 507
BRENNPASTE	263, 389

BRULLIERBRENNEN	334, 335
BRUSH FÜR SCHNEIDEBRETT	225
BUTTERDOSE MIT DECKEL	259

## C

CHAFING DISH	385, 386, 387, 388, 389, 390, 391, 512
CHAFING HEIZUNG	389, 512
CHAMPAGNERKÜHLE	299, 300
COCKTAIL-MATTE	305
COCKTAIL-TASSEN	306
COCKTAIL-UTENSILIEN	305
COCKTAILMASS	308
COCKTAILSHARKER	307
CRÉPES-PFANNE	39, 85, 89, 93, 95, 97, 103, 508

## D

DAMPFKOCH-AUFSATZ	25, 43, 44, 47, 49, 51, 55, 152
DAMPFKOCHGERÄT	484
DECKEL	22, 26, 28, 29, 32, 35, 37, 39, 41, 43, 45, 47, 49, 51, 52, 55, 57, 59, 61, 90, 115, 395

DEKORIEREN PLASTIKKAMME	324
DOPPEL-BODEN	421, 422, 423
DOSIERER	150
DOSIERFLASCHE	64, 249
DREIECK	147

## E

EI-UNTERSTÜTZUNG	153
EIER-SEPARATOR	153
EIERFORM	153

EIERKOCHER	455
EIMER	178
EIS MACHINE	460, 552
EIS MACHINEN	552
EIS-CRUSHER	307, 553
EISKELCH	343
EISPORTIONIERER	343
EITELLER	231
ELEKTRITOASTER	406, 528, 529
ELEKTROFLIEGENFÄNGER	559, 560, 561
ELEKTROGRILL	501
ENSEMBLE D'USTENSILES	131
ENTBLÄTTERER FÜR GEWÜRZKRÄUTER	198
ESPUMADOR DE LEITE	284, 528

## F

FETTABSCHIEDER	264
FILTERKAFFEE	524, 525
FISCHKESSEL	32
FISCHSCHUPPENTFERNER	273
FLASCHENKÜHLER	295
FLASCHENUNTERSETZER	231
FLEISCHKLOPFER	160
FLEISCHSPIESSE	136
FLEISCHTOPF	21, 24, 27, 29, 30
FLEISCHWOLF	480
FLEISCHZANGE	199
FOLIENCUTTER	309
FONDUE	263, 510
FRITEUSE	487, 488, 489, 490, 491, 492, 493, 494
FRITIERLÖFFEL	126, 200
FRÜHSTÜCKSTELLER	235, 237, 243, 432, 433

## G

GASANZÜNDER	262
GASKOCHER-STÄNDE	110
GEFLÜGELSCHERE	217
GEMÜSESCHNEIDER	460, 482, 484
GEMÜSETOPF	21, 24
GETRANKENPENDER	392, 523
GEWÜRZDOSE/STREUER	265
GEWÜRZKASTEN	163
GLAS	282, 306, 433
GLASUNTERSETZER	231
GLOCKE	260, 399
GN DECKEL	421, 422, 423
GN ZWISCHENSTENG	420
GN-BEHÄLTER	395, 418, 419, 420, 422, 423, 425
GN-BEHÄLTER, PERFORIERT	419, 420
GRILL	57, 59, 91, 95, 97
GRILL AKTENTASCHE	134
GRILLSPIESS	88

## H

HACKFLEISCHMESSER	213
HAMBURGER-FORMEN	159
HAMMER	160
HANDPRESSE FÜR TOMATEN	199
HANDSCHUH	63, 120
HOHER FLEISCHTOPF	41, 45, 47, 49, 51, 54
HOLZ-STÖSSEL	147
HONIGBEHÄLTER	265, 393, 394

# DE Alphabetischer Index

HONIGLÖFFEL	272
HOT DOG WÄRMER	456
HUMMERGABEL	273
HUMMERZANGE	272

## I

INOX-BEHÄLTER	179, 180, 181
ISOLATIONSKUNGLN FÜR SOUS VIDE	547
ISOTHERMAL SCHALE/TABLETT	426, 432

## L

LEDERSCHNUR	367
LEISCH BÄRENKRALLEN	154, 196
LLAUNAS ARROZ	113
LÖFFELSAMMLER IN GESCHIRR	136

## M

MAGNETHALTERUNG FÜR MESSER	219
MANDOLINE	202, 203
MANUELLE WURSTTÜLLER	165
MARKER TAFEL	362, 556
MASCHINE FUER GLAS COOL	554
MEHLBEHÄLTER	149
MEHLSCHAUSEL	307, 319
MEHLSIEB	323
MELAMIN	241, 242, 244, 246, 254, 399
MENAGE	264
MENÜ-STÄNDER	363
MENÜKARTENHALTER	260
MESSER	134, 191, 192, 193, 208, 209, 210, 211, 212, 214, 215, 216
MESSER-ORGANISATOR	226
MESSERHALTER	213, 218
MESSERTASCHE	213
MESSGERÄT	175, 176, 318, 321
MIKROWELLE	497
MILCHKANNE	290, 292
MILCHTOPF	31, 41, 43, 45, 47, 49, 51, 52, 55
MINI GRILL	504
MINI-WÜRFEL	255
MIXER	462, 463, 464, 465, 467, 468, 469, 470, 474, 476, 477, 478, 533, 534, 535, 536, 537
MOJITOSTÖSSSEL	160, 308
MÖRSER	155
MULTIFUNKTIONS-ROBOTER	225, 483

## N

NESTBACKLÖFFEL	147
NUDELKOCH-EINSATZ	44
NUSSKNACKER	272

## O

OBSTTROCKNER	485
OFEN	495, 496, 497
ORGANIZER FÜR COCKTAILZUBEHÖR	306

## P

PARMESAMENAGE	224, 260
PASSIERGERÄT	157
PASTETENFORMEN	157

PERSÖNLICHE FLASCHE	282
PFANNE	38, 43, 45, 47, 51, 52, 55, 59, 61
PINSEL	134
PISTOLE FÜR TÜLLENSATZE	340
PIZZABLECH	142, 353
PIZZAOFEN-SCHAUFEL	142, 143
PIZZASCHNEIDER	143
PIZZASPATEL	142
PLATTE GRILL	89, 93, 94, 501, 502
PUDDING-/BECHERFÖRMCHEN	350, 352, 353

## R

RACK FÜR SOUS VIDE	547
RAUCHERGLOCKE	172
RECLLETTE	503
RESERVED INDIKATOR	260
REZEPTIONSKLINGEL	261
ROLLENHALTER	539
ROLLFILM	452
RUHRPATEL	139
RUNGSTOOLS	324

## S

SAHNEBEREITER	170, 337
SALATSCHÜSSEL	259
SALZ-PFEFFERTREUER	266, 267, 284, 524
SATZ-PFEFFER-SET	264
SAUCENGLIESSLÖFFEL	142
SAUCIERE	259
SAUTEUSE	22, 25, 28, 49
SAUTEUSE, KONISCH	22, 26
SCHÄLER	191, 192, 193, 194, 207
SCHÄRFMASCHINE	220, 221, 557
SCHAUFEL	324
SCHAUFEL FÜR POMMES FRITES	140
SCHAUMLÖFFEL	126
SCHINKENHALTER	205
SCHNEEBESEN	291, 465, 471, 472, 473, 475
SCHNEIDEBRETT	205, 222, 223, 224, 225
SCHNEIDER	191, 192, 194, 197, 198, 199, 481
SCHNELLKOCHTOPF	71, 72, 73, 74, 75, 76, 77, 78
SCHOKOLADENKOCHER	510
SCHÖPFKELLE	135
SCHÜSSEL	176, 177, 235, 237, 239, 240, 253, 259, 320, 321
SEIHER, MIT STIEL	45, 47, 51, 55, 146, 147, 308
SEKTKÜHLER	296, 307
SEKTKÜHLERSTÄNDER	298
SERVIERLÖFFEL	240
SERVIERSCHÜSSEL	259
SERVIERTABLET	113, 242, 253, 430, 431
SERVIERTISCH	247, 253
SERVIERWAGEN	427, 428, 433
SERVETTENPENDER	261, 452
SERVETTENROLLE	451, 452
SILIKONGRIFF	59, 120
SOSENSPRITZE	167
SOUS VIDE	544, 545, 546
SPAGHETTI-MASS	164
SPEISEKARTENMAPPE	364, 367, 370, 371, 372, 373, 374, 375, 376, 377, 378, 379, 380, 381, 382
SPICKNADEL	167
SPRITZBEUTEL	338
SPÜLKORB	447, 448

# DE Alphabetischer Index

STÄNDER EISKELCH	304	WENDEWAFFLEISEN	507
STÄNDER FUER BRENNER	110	WETZSTAHL	213, 215
STANDMIXER BRISK	467, 470	WOK	39, 43, 85, 86, 89, 93, 95, 97, 100, 103
STERILISIERUNGSSCHANK	548, 558	WÜRSTCHENGRILL	456
STIELKASSEROLLE, FRANZÖSISCH	22, 26		
STIELKASSEROLLE, HFLACH	22, 25, 28, 29, 31, 35, 37, 38, 41, 43, 45, 47, 49, 51, 52, 53, 54, 55, 57, 59, 61, 63, 64, 88, 178, 249		
STIELKASSEROLLE, HOCH	22, 25, 28, 31		
STÖSSEL	155		
SUPPENBEREITER	514, 563, 564, 565, 566		
SUPPENSCHÜSSEL	259		
SUPPENTOPF	21, 24, 28, 29, 31, 38, 41, 43, 44, 46, 48, 50, 52, 53, 54, 61, 452, 501		

<b>T</b>			
TABLETTHALTER	231		
TAFEL	232, 362, 364, 396, 556		
TAFEL FÜR BESTELLUNGEN	373, 374		
TAFEL FÜR RECHNUNGEN	371, 373, 374		
TASSE	433		
TEEKANNE	290, 291		
TEIGAUSSTECHER	331		
TEIGROLLER	330		
TEIGSCHABER	134, 135, 138, 139, 326, 342		
TELLERABDECKUNG	260, 399, 433		
TELLERHALTER	429		
THERMOBEHÄLTER	280, 281, 282		
THERMOMETER	188, 189		
THERMOMOSKANNE	279, 280		
THERMOTRANS	426		
TISCH-VITRINE	312, 313, 314, 315		
TISCHHALTERUNG	298		
TISCHNUMMERNSCHILD	260, 303		
TISCHSET	275, 276		
TISCHTUCHKLAMMER	260		
TISH-ABFALLBEHÄLTER	261, 450		
TORTENNING	352, 358, 359		
TORTENNING, GELOCHT	359		
TORTENTEILER	342		
TRANCHIERGABEL	134, 212, 214		
TRICHTER	150		
TUBULÄRE REGAL	428		
TÜLLENSATZ	339		

<b>V</b>			
VAKUUM-BEHÄLTER	542		
VAKUUMBEUTEL	542		
VAKUUMBEUTEL ROLLEN	542		
VAKUUMIERGERÄT	162, 538, 539, 540, 541		
VERPFLEGUNG	397		
VOLLE REGALE	436, 437, 438, 439, 440, 441, 442, 443, 444		

<b>W</b>			
WANDSPENSER SEIFE	449		
WANDTRENNPFOSTEN	453		
WANNE	178, 322		
WARMHALTEPLATTE	525		
WASSER SAHNEBEREITER	308		
WASSERKANNE	302, 433		
WASSERWARMER	292, 293, 521, 522		
WEINBELÜFTER	309		
WEINKÜHLER	549, 551		
WEINRING TROP-STOP	309		

# EN Alphabetical index

<b>A</b>			
AIRBRUSH	333, 511		
AIRPOT	392, 523		
APPLE CORER	192, 193, 198		

<b>B</b>			
BAGUETTE MOULD	354		
BAIN MARIE	26, 28, 341, 509, 514		
BARBECUE BRIEFCASE	134		
BASE FOR BURNER	110		
BASKET	152, 255		
BEAR CLAWS FOR MEAT	154, 196		
BELL	260, 399		
BIRD'S NEST MOULD	147		
BISCUIT STAMP	332		
BLACKBOARD	232, 362, 364, 396, 556		
BOTTLE COOLER	295		
BOTTLE STAND	231		
BOWL	176, 177, 235, 237, 239, 240, 253, 259, 320, 321		
BREAD BASKET	256		
BRISK BLENDER STAND	467, 470		
BRUSH	134		
BRUSH FOR CUTTING BOARD	225		
BURNER	110		
BUTTER DISH WITH COVER	259		

<b>C</b>			
CAKE CUTTERS	332		
CAKE MARKER	342		
CAKE SPOON	192		
CAKE STAND	342		
CALL BELL	261		
CARAMIZER	335, 507		
CASSEROLE	20, 23, 27, 29, 30, 35, 37, 38, 41, 43, 44, 46, 48, 50, 52, 53, 54, 56, 57, 59, 61, 65, 395		

<b>CATERING</b>			
CHAFING DISH	385, 386, 387, 388, 389, 390, 391, 512		
CHAFING HEATER	389, 512		
CHEESE/CAKE COVER	260		
CHINESSE STRAINER PUSHER	147		
CHOCOLATE FOUNTAIN	511		
CHOCOLATE MACHINE	510		
CHOPPER	195, 479		
CLEAVER	213		
CLING FILM	452		
COCKTAIL ACCESSORY ORGANISER	306		
COCKTAIL CUPS	306		
COCKTAIL MAT	305		
COCKTAIL SET	305		
COCTAIL SHARKER	307		
COFFEE ORGANIZER	393		
COFFEE PERCOLATOR	393, 523		
COFFEE POT	285, 286, 287, 288, 289, 290, 526, 527		
COIL TUBE	542		
COLANDER WITH STAND	45, 47, 51, 55, 148, 149		
COLD MEAT CUTTER	481		
CONDIMENTS HOLDER	163		
CONICAL DISH	178, 322		
CONICAL SAUTE PAN	22, 26		
CONTAINER	395, 418, 419, 420, 422, 423, 425		
CONTAINER LID	421, 422, 423		
COOK'S CASE	213		

COOKIE CUTTER	331		
COOKIE PRESS	340		
COOLER	551		
CORKSCREW	310, 311, 550		
COUSCOUS POT	55		
COVERING	117, 350		
CREAMER	290, 292		
CREPIERE	39, 85, 89, 93, 95, 97, 103, 508		
CRUET SET	264		
CRUMBS CLEANER	261, 451		
CUP	343		
CUPS STAND	304		
CUTLERY	226		
CUTLERY ORGANIZER	226		
CUTTER	191, 192, 194, 197, 198, 199, 481		
CUTTING BOARD	205, 222, 223, 224, 225		
CUTTLERY HOLDER	136		
CYLINDRICAL POT	31, 41, 43, 45, 47, 49, 51, 52, 55		

<b>D</b>			
DECORATING COMBRE	324		
DEEP CASSEROLE	21, 24, 27, 29, 30		
DEEP SAUCEPAN	22, 25, 28, 31		
DEEP STOCK POT	41, 45, 47, 49, 51, 54		
DEHYDRATOR	485		
DISH CART COVER	428		
DISH MAT	452		
DISPENSER	265, 393, 394		
DISPLAY VASE	312, 313, 314, 315		
DOUBLE BOTTOM	421, 422, 423		
DUMPLING MOULD	157		

<b>E</b>			
EGG COOKER	455		
EGG SERVING DISH	231		
EGG STAND	153		
EGGS SEPARATOR	153		
EXPOSANT	396		

<b>F</b>			
FILTER COFFE MACHINE	524, 525		
FISH KETTLE WITH GRILL AND LID	32		
FISH SCRAPER	273		
FLOUR BIN MESH	149		
FOIL CUTTER	309		
FONDUE	263, 510		
FORK	134, 212, 214		
FRENCH SAUCEPAN	22, 26		
FRUIT BOWL	256		
FRY COLANDER	149		
FRYER	487, 488, 489, 490, 491, 492, 493, 494		
FRYING-PAN	35, 37, 39, 45, 49, 57, 59, 61, 65, 80, 81, 82, 83, 84, 85, 87, 88, 90, 91, 92, 94, 95, 96, 97, 98, 99, 100, 101, 102, 103, 104, 249		
FUEL GEL BUCKET	263, 389		
FUNNEL	150		

<b>G</b>			
GARLIC PRESS	156, 192, 201		
GAS LIGHTER	262		
GAS TORCH	334, 335		

GLAS RIMMER	306
GLASS	282, 306, 433
GLASS COOLER MACHINE	554
GLASS STAND	231
GLOVE	118, 119
GRATER	200, 201
GRAVY BOAT	259
GRAVY LADLE	142
GRAVY/FAT SEPARADOR	264
GRILL	57, 59, 91, 95, 97
GRILL PLAQUE	89, 93, 94, 501, 502
GRINDER	266, 267, 284, 524

## H

HAM-SUPPORT	205
HAMBURG PRESSER	159
HAMMER	160
HEATER	514, 563, 564, 565, 566
HEATING LAMP	516, 517
HERB STRIPPER	198
HONEY SPOON	272

## I

ICE BUCKET	296, 307
ICE CREAM MAKING MACHINE	460, 552
ICE CREAM SCOOP	343
ICE CRUSHER	307, 553
ICE CUBES MAKER	552
ICE SHOVEL	307, 319
INDIVIDUAL PLACEMENT	275, 276
INDUCTION PLATE	498, 499
INOX CONTAINERS	179, 180, 181
ISOTHERMAL TRAY	426, 432

## L

LADLE	135
LEATHER LACE	367
LID	22, 26, 28, 29, 32, 35, 37, 39, 41, 43, 45, 47, 49, 51, 52, 55, 57, 59, 61, 90, 115, 395
LLAUNAS ARROZ	113
LOBSTER CRACKER	272
LOW CASSEOLE	37, 56, 57
LOW STOCK POT	21, 24

## M

MACE	160, 308
MAGNET SUPPORT	219
MANDOLINE	202, 203
MANUAL STUFFER	165
MANUAL TOMATO CHOPPER	199
MARKERS BLACKBOARD	362, 556
MEASURER	175, 176, 318, 321
MEAT MINCER	480
MEAT TENDERIZER	160
MEAT TONG	199
MELAMINE	241, 242, 244, 246, 254, 399
MENU CARD HOLDER	260
MENU COVER	364, 367, 370, 371, 372, 373, 374, 375, 376, 377, 378, 379, 380, 381, 382
MENU HOLDER LECTERN	363
MESH SKIMMER	126, 200

MICROWAVE	497
MILK FROTHER	284, 528
MINI GRILL	504
MINI-CUBE	255
MITTEN	63, 120
MIXER	462, 463, 464, 465, 467, 468, 469, 470, 474, 476, 477, 478, 533, 534, 535, 536, 537
MIXING BOWL	178, 322
MORTAR	155
MOSKITO KILLER	559, 560, 561
MULTIFUNCTION ROBOT	225, 483

## N

NAPKIN HOLDER	261, 452
NOZZLES	339
NUT CRACKER	272

## O

OIL CAN	264
OIL SPRAYER	264
ORDER HOLDER	373, 374
ORDER RALL	136
ORGANIZING BOTTLES	163
OUSTER OPENNER	192, 272
OVEN	495, 496, 497
OVEN TRAY	32, 355

## P

PAIL	178
PARMESAN BOWL	224, 260
PASTA COOKER	44
PASTA MEASURER	164
PASTRY BAG	338
PASTRY MOULD	345, 346, 347, 348, 349, 350, 352, 353, 355, 356, 358
PEELER	191, 192, 193, 194, 207
PERFORATED CONTAINER	419, 420
PERFORATED RINGS	359
PERSONAL BOTTLE	282
PESTLE	155
PIZZA CUTTER	143
PIZZA FLAT SCOOP	142, 143
PIZZA MOULD	142, 353
PIZZA SPATULA	142
PLATE	235, 237, 243, 432, 433
PLATE COVER	260, 399, 433
PLATE HOLDER	429
PORTIONNER	150
POTATO CUTTER	198
POTATO MASHING MACHINE	157
POTATO PRESS	156
POURER	64, 249
PRESSURE COOKER	71, 72, 73, 74, 75, 76, 77, 78
PUDDING MOILD	350, 352, 353

## R

RACK	447, 448
RACK FOR DOUS VIDE	547
RECLLETTE	503
REMOVABLE GRIP / HANDLE	35, 102
RESERVED SIGNAL	260

RINGS	352, 358, 359
ROASTER	26, 32, 112, 114, 115
ROLL DISPENSER	451, 452
ROLL HOLDER	539
ROLLING PIN	330
ROTISSERIE	88
ROUND	22, 25, 28, 29, 31, 63, 65, 85, 88, 93, 106, 107, 108, 109, 110, 249

ROUND DISH	38, 43, 45, 47, 51, 52, 55, 59, 61
ROUNDED SAUCEPAN	31
RTUBULAR SHELF	428

## S

SALAD BOWL	259
SALAMANDER	501
SALT-PFEFFER SET	264
SAUCE SYRINGE	167
SAUCEPAN	22, 25, 28, 29, 31, 35, 37, 38, 41, 43, 45, 47, 49, 51, 52, 53, 54, 55, 57, 59, 61, 63, 64, 88, 178, 249

SAUSAGE COOKER	456
SAUSAGE ROASTER	456
SAUTEUSE	22, 25, 28, 49
SCALE	182, 183, 184, 185, 186, 187, 319, 555
SCISSORS	217
SCRAPER	324
SEAFOOD FORKS	273
SEPARATOR POST	453
SERVICE TROLLEY	427, 428, 433
SERVING TABLE	247, 253
SERVING TRAY	231, 232
SHAPE EGG MOULD	153
SHARKER	265
SHARPENING	213, 215
SHEETS	485
SHELVING	436, 437, 438, 439, 440, 441, 442, 443, 444

SHOVEL	139
SHOVEL FOR FRENCH FRIES	140
SIEVE	323
SILICONE HANDLE	59, 120
SKEWERSQUARE	136
SKIMMER	126
SLICER	164, 194, 199
SMOKER	171
SMOKER HOOD	172
SOAP WALL DISPENSER	449
SOUP-TUREEN	259
SOUS VIDE	544, 545, 546
SOUS VIDE INSULATION BALLS	547
SPATULA	138, 139, 192

SPICE COOKER	152
SPINNER	166
SPLITTING GUIDES	420
SPOON	240
SPOON HOLDER UTENSILS	136
SPOUT FOR WINE	309
SQUEEZER	161, 530, 531, 533
STEAM CASSEOLE	25, 43, 44, 47, 49, 51, 55, 152
STEAM COOKER	484
STEAMER	152
STOCK POT	21, 24, 28, 29, 31, 38, 41, 43, 44, 46, 48, 50, 52, 53, 54, 61, 452, 501

STRAINER	45, 47, 51, 55, 146, 147, 308
STRAWS	535

STUFFING NEEDLE	167
SUGAR BOWL	260, 290

## T

TABLE BIN	261, 450
TABLE NUMBERS	260, 303
TABLECLOTH PROTECTOR	277
TABLECLOTHS PEGS	260
TEA POT	290, 291
TERMO JUG	279, 280
THERMO	280, 281, 282
THERMOMETER	188, 189
THERMOTRANS	426
TICKET HOLDER	371, 373, 374
TOASTER	406, 528, 529
TONG	134, 268, 269, 270, 271, 308, 342, 421
TONGS	269
TOOLS	324
TRAY	113, 242, 253, 430, 431
TRAY STAND	231
TRIANGLE	147
TRING	352

## V

VACUUM BAGS	542
VACUUM CANISTERS	542
VACUUM PACK MACHINE	162, 538, 539, 540, 541
VEGETABLE DISH	259
VEGETABLES CUTTER	460, 482, 484
VINE BUCKET	299, 300

## W

WAFFLE MAKER	507
WARMING PLATE	525
WATER JUG	302, 433
WATER WHIPPER	308
WHIPPER	170, 337
WHISK	291, 465, 471, 472, 473, 475
WINE AERATOR	309
WINE COOLER	549, 551
WINE DRIP STOP RING	309
WINE STAND	298
WINE TABLE SUPPORT	298
WOK	39, 43, 85, 86, 89, 93, 95, 97, 100, 103

# PT Índice alfabético

## A

ABERTO-OSTRAS	192, 272
AÇUCAREIRO	260, 290
AERÓGRAFO	333, 511
AFIADOR DE FACAS	220, 221, 557
AGULHA DE MECHAR	167
AIRPOT	392, 523
ANILHA ANTI-GOTA	309
AQUECEDOR	514, 563, 564, 565, 566
AQUECEDOR CHAFING	389, 512
ARDÓSIA	232, 362, 364, 396, 556
AREJADOR DE VINHO	309
ARGAMASSA	155
ARMÁRIO ESTERILIZADOR	548, 558
ARMÁRIO REFRIGERADOR	549, 551
ARO	352, 358, 359
ARO PERFURADO	359
ASA DE SILICONE	59, 120
ASSADEIRA	26, 32, 112, 114, 115
ASSADOR DE SALSICHAS	456
ATRIL PORTA-MENU	363
AZEITEIRA	264

## B

BACIA	176, 177, 235, 237, 239, 240, 253, 259, 320, 321
BACIA CÔNICA	178, 322
BACIA DA ENSALADA	259
BALANÇA	182, 183, 184, 185, 186, 187, 319, 555
BALDE	178
BANDEJA	113, 242, 253, 430, 431
BANDEJA / TRAVESSA	230, 231, 232, 234, 235, 236, 237, 239, 240, 243, 253, 261
BANDEJA DE SERVIR	231, 232
BANDEJA FORNO	32, 355
BANDEJA ISOTÉRMICA	426, 432
BANHO-MARIE	26, 28, 341, 509, 514
BARRA FIXAÇÃO NOTAS	136
BATEDEIRA	462, 463, 464, 465, 467, 468, 469, 470, 474, 476, 477, 478, 533, 534, 535, 536, 537
BATEDOR	291, 465, 471, 472, 473, 475
BLADE ARREFECEDORA DE GARRAFAS	299, 300
BOBINA DE VÁCUO	542
BOBINA FILME	452
BOQUILHA DE SERVIR	309
BOQUILHAS	339
BULE	290, 291

## C

CAÇAROLA	20, 23, 27, 29, 30, 35, 37, 38, 41, 43, 44, 46, 48, 50, 52, 53, 54, 56, 57, 59, 61, 65, 395
CAÇAROLA A VAPOR	25, 43, 44, 47, 49, 51, 55, 152
CAÇAROLA ALTA	21, 24, 27, 29, 30
CAÇAROLA ALTA DIREITE	22, 25, 28, 31
CAÇAROLA BAIXA	37, 56, 57
CAÇAROLA BOJUDA	31
CAÇAROLA CÔNICA	22, 26
CAÇAROLA DIREITE	22, 25, 28, 29, 31, 35, 37, 38, 41, 43, 45, 47, 49, 51, 52, 53, 54, 55, 57, 59, 61, 63, 64, 88, 178, 249
CAFÉ TIPO FILTRO	524, 525
CAFETEIRA	285, 286, 287, 288, 289, 290, 526, 527
CAIXA	395, 418, 419, 420, 422, 423, 425

CAIXA CONDIMENTOS	163
CAIXA PERFURADA	419, 420
CAIXAS VÁCUO	542
CAMPAINHA	261
CAMPÂNULA DEFUMADORA	172
CANECA CILÍNDRICA	31, 41, 43, 45, 47, 49, 51, 52, 55
CAPA PROTECTORA CARRO	428
CARIMBOS PARA BOLACHAS	332
CARRO SERVIÇO	427, 428, 433
CENTRIFUGADORA	166
CEPILHO PARA TÁBUA DE CORTE	225
CESTA	152, 255
CHAFING DISH	385, 386, 387, 388, 389, 390, 391, 512
CHALEIRA	292, 293, 521, 522
CHÁVENA	433
CHOCOLATEIRA	510
CLOCHE PARA PRATOS	260, 399, 433
CLOQUE PARA QUEIJO/TARTES	260
COADOR	45, 47, 51, 55, 146, 147, 308
COBERTO	226
COLHER LISA	240
COLHER PARA MEL	272
COLHER RECOLHE UTENSÍLIOS	136
CONCHA	135
CONCHA PARA MOLHO	142
CONJUNTO DE UTENSÍLIOS	131
CONJUNTO DE UTENSÍLIOS PARA PREPARAR COCKTAILS	305

CONTENTORES INOX	179, 180, 181
COPO	282, 306, 433
COPOS DE COCKTAIL	306
CORDÃO DE COURO	367
CORREDOR	307, 319
CORRENTE	352
CORTA VEGETALES	460, 482, 484
CORTA-MASSAS	331
CORTA-PIZZA	143
CORTADOR	191, 192, 194, 197, 198, 199, 481
CORTADOR DE BATATA	198
CORTADORA DE FIAMBRE	481
CORTADORES DE BOLO	332
COUSCOUSEIRAR	55
COZE-MASSAS	44
COZEDOR DE ESPECIARIAS	152
CREMALHEIRA PARA SOUS VIDE	547
CREPEIRA	39, 85, 89, 93, 95, 97, 103, 508
CUTELO	213

## D

DECORADOR DE COPOS E TAÇAS	306
DEFUMADOR	171
DESCAPSULADOR	309
DESCAROÇADOR	192, 193, 198
DESCASCADOR	191, 192, 193, 194, 207
DESFOLHADOR DE ERVAS	198
DESIDRATADOR	485
DISIFICADOR LICOR	308
DISPENSADOR DE SABÃO	449
DOSIFICADOR	150
DUPLO FUNDO	421, 422, 423

## E

EARREFECEDOR DE GARRAFAS	295
ESCORRE-FRITOS	149
ESCORREDOR	45, 47, 51, 55, 148, 149

# PT Índice alfabético

ESCORREDOR PARA PRATOS	452
ESCOVA APANHA-MIGALHAS	261, 451
ESCUMADEIRA	126, 200
ESFERAS ISOLANTES SOUS VIDE	547
ESMAGA-ALHOS	156, 192, 201
ESPÁTULA	134, 135, 138, 139, 326, 342
ESPÁTULA DE BOLOS	192
ESPÁTULA LISA	138, 139, 192
ESPÁTULA PIZZA	142, 143
ESPETO MORUNO	136
ESPETOS PARA MARISCO	273
ESPREMEDOR	161, 530, 531, 533
ESPUMADOR DE LEITE	284, 528
ESTANTE	436, 437, 438, 439, 440, 441, 442, 443, 444
EXPOSITOR	396

## F

FACA	134, 191, 192, 193, 208, 209, 210, 211, 212, 214, 215, 216
FARINHEIRO	149
FERRAMENTAS	324
FIO DE COZINHA	117
FONDUE	263, 510
FONTE CHOCOLATE	511
FORMA FLAN	350, 352, 353
FORMA PARA SALGADOS	157
FORNO	495, 496, 497
FRANCÊS CAÇAROLA	22, 26
FRIGIDEIRA	22, 25, 28, 49
FRITEDEIRA	487, 488, 489, 490, 491, 492, 493, 494
FUNIL	150
FUSIL	213, 215

## G

GARFO	134, 212, 214
GARRAFA DOSEADORA	64, 249
GARRAFA PESSOAL	282
GARRAS DE URSOPARA CARNE	154, 196
GEL COMBUSTÍVEL	263, 389
GRELHA	152
GRELHADOR	57, 59, 91, 95, 97
GUARDANAPO	261, 452
GUIA DIVISÓRIA	420

## I

IMPRESA POTATO	156
INDICADOR RESERVADO	260
IOGURTEIRA	458, 459
ISQUEIRO	262

## L

LÂMINA	485
LEGUMEIRA	259
LEITEIRA	290, 292
LIQUIDIFICADORAS	532
LLAUNAS ARROZ	113
LUVA	118, 119

## M

MAÇO	160, 308
MALA CHEF	213
MALETA DE CHURRASCO	134
MANDOLINA	202, 203
MANGA DE PASTELERIA	338

MANTEIGUEIRA	259
MÁQUINA DE COZER OVOS	455
MÁQUINA DE COZER SALSICHAS	456
MÁQUINA DE FAZER GELO	552
MAQUINA DE FAZER GOFFRES	507
MÁQUINA DE VACÚO	162, 538, 539, 540, 541
MÁQUINA PARA ENCHER SALSICHAS MANUAL	165
MÁQUINA PARA ENFRIAR COPAS	554
MÁQUINA PARA FAZER GELADO	460, 552
MÁQUINA/PERCOLADOR DE CAFÉ	393, 523
MARCADOR DE BOLOS	342
MARCADORES ARDÓSIA	362, 556
MARTELO	160
MARTELO ABLANDADOR	160
MATA MOSQUITOS	559, 560, 561
MEDIDOR	175, 176, 318, 321
MEDIDOR OARA MACARRAO	164
MELAMINA	241, 242, 244, 246, 254, 399
MICROONDAS	497
MINI GRILL	504
MINI-CUBO	255
MOINHO	266, 267, 284, 524
MOLDE OVO	153
MOLDE PARA HAMBÚRGUERES	159
MOLDE PASTELERÍA	345, 346, 347, 348, 349, 350, 352, 353, 355, 356, 358
MOLDE PIZZA	142, 353
MOLHEIRA	259

## N

NINHOS DE ARAME	147
NÚMEROS PARA TABELA	260, 303

## O

ORGANIZADOR ACCESSÓRIOS COCKTAILS	306
ORGANIZADOR DE CAFÉ	393
ORGANIZADOR DE FACAS	226
ORGANIZADOR DE TALHERES	226
ORGANIZANDO FRASCOS	163

## P

PÁ	139
PÁ PARA FRITAS FRANCAS	140
PAELHEIRA	22, 25, 28, 29, 31, 63, 65, 85, 88, 93, 106, 107, 108, 109, 110, 249
PAELHEIRA GÁS BUTANO	110
PANELA	21, 24, 28, 29, 31, 38, 41, 43, 44, 46, 48, 50, 52, 53, 54, 61, 452, 501
PANELA BAIXA	21, 24
PANELA DE COCÇÃO	484
PANELA DE PRESSÃO	71, 72, 73, 74, 75, 76, 77, 78
PANELA SUPER ALTA	41, 45, 47, 49, 51, 54
PAPELEIRA	261, 450
PARTE-NOZES	272
PASSA-PURÉ	157
PÉ PORTA BALDES	298
PEGAS	63, 120
PEIXEIRA	32
PENEIRA	323
PENTE DE DECORAÇÃO	324
PICADORA	195, 479
PICADORA DE CARNE	480
PICADORA DE GELO	307, 553
PILÃO P/ALMOFARIZ	155

PILÃO P/PASSADOR CHINÊS	147
PINÇA	134, 268, 269, 270, 271, 308, 342, 421
PINÇA PARA TOALHAS	260
PINÇA/PENTE CORTA-CARNE	199
PINÇAS	269
PINCEL	134
PIPETA PARA MOLHO	167
PISTOLA PASTELARIA	340
PLACA AQUECIMENTO	525
PLACA DE FORNO	116
PLACA DE INDUÇÃO	498, 499
PLACA VITROCERÂMICA	500
PLANCHA GRILL	89, 93, 94, 501, 502
POLVILHADOR	265
PORTA COMANDAS	373, 374
PORTA FATURAS	371, 373, 374
PORTA MENU	364, 367, 370, 371, 372, 373, 374, 375, 376, 377, 378, 379, 380, 381, 382
PORTA PLACA	429
PORTA-CUBOS GELO	296, 307
PORTA-ROLOS	451, 452
PORTA-TARTE	342
POSTE SEPARADOR	453
POUSA-COPOS	231
POUSA-GARRAFAS	231
PRATELEIRA TUBULAR	428
PRATO	235, 237, 243, 432, 433
PRATO DE OVOS	231
PROTECTOR DE TOALHAS	277
PULVERIZADOR	264

## R

RACIONADOR DE GELADO	343
RALADOR	200, 201
RASPADOR	324
RASPADOR DE PEIXE	273
RECLLETTE	503
REFRIGERADOR	551
REMOVÍVEL PEGA / ADERÊNCIA	35, 102
RESTAURAÇÃO	397
ROBÔ MULTIFUNCIONAIS	225, 483
ROLO	330

## S

SACA-ROLHAS	310, 311, 550
SACOS DE VÁCUO	542
SALAMANDRA	501
SEPARADOR DE GORDURAS	264
SEPARADOR DE OVOS	153
SERTÃ	35, 37, 39, 45, 49, 57, 59, 61, 65, 80, 81, 82, 83, 84, 85, 87, 88, 90, 91, 92, 94, 95, 96, 97, 98, 99, 100, 101, 102, 103, 104, 249
SHARKER	307
SIFÃO	170, 337
SIFÃO DE ÁGUA	308
SINO	260, 399
SOPEIRA	259
SOUS VIDE	544, 545, 546
SUPORTE BALDE DE ARREFECEDOR	298
SUPORTE DE OVO	153
SUPORTE DE ROLO	539
SUPORTE DE TAPAS	304
SUPORTE MAGNÉTICO	219
SUPORTE MENÚ	260

SUPORTE PAELHERIA	110
SUPORTE PARA BANDEJAS	231
SUPORTE PARA BATEDEIRA BRISK	467, 470
SUPORTE PRESUNTO	205

## T

TÁBUA DE CORTE	205, 222, 223, 224, 225
TÁBUA DE SERVIR	247, 253
TAÇA	343
TACO FACAS	213, 218
TAMPA	22, 26, 28, 29, 32, 35, 37, 39, 41, 43, 45, 47, 49, 51, 52, 55, 57, 59, 61, 90, 115, 395
TAMPA PARA CAIXA	421, 422, 423
TAPETE	117, 350
TAPETE PARA COCKTAILS	305
TARTEIRA	38, 43, 45, 47, 51, 52, 55, 59, 61
TENAZ MARISCOS	272
TERMO	280, 281, 282
TERMÓMETRO	188, 189
TESOURAS	217
THERMOTRANS	426
TOALHA DE MESA INDIVIDUAL	275, 276
TORRADEIRA	406, 528, 529
TRIÂNGULO	147
TRITURADOR MANUAL DE TOMATE	199

## V

VITRINA EXPOSITORA	312, 313, 314, 315
--------------------	--------------------

## W

WOK	39, 43, 85, 86, 89, 93, 95, 97, 100, 103
-----	--

## Condições gerais de venda

Conditions générales de vente · Allgemeine Geschäftsbedingungen  
General conditions of sale · Condições gerais de venda



### ES

- Los precios de la **presente tarifa** anulan los anteriores.
- En los precios están incluidos los **conceptos de embalaje**.
- El **medio de transporte** será a elección de esta Empresa. Cuando se desee el envío por un medio diferente al habitual de **LACOR**, los portes serán **DEBIDOS**.
- La forma de pago será mediante **GIRO DOMICILIADO** y el **plazo máximo** para el pago serán **60 días**. Otras formas de pago deberán ser autorizadas por la dirección de la Empresa.
- Todas las **devoluciones de mercancías** tienen que ser **autorizadas** por la Empresa. Las **devoluciones** que no sean por problemas de calidad deberán llegar a portes pagados y se abonarán al 90% del valor de la mercancía.
- Las **fotos, datos y medidas** que aparecen en este catálogo son indicativos y susceptibles, sin previo aviso, de modificación por exigencias técnicas o de producción.

### FR

- Les **présents tarifs** annulent les précédents.
- Dans les prix sont inclus les **concepts d'emballage**.
- Le **moyen de transport** sera au choix de cette entreprise. Si l'on désire l'envoi par un moyen différent à celui pratiqué habituellement par **LACOR**, les ports seront **DUS**.
- La forme de paiement sera par **LETTRE DE CHANGE BANCAIRE** et le délai de paiement maximum sera de **60 jours**. D'autres formes de paiement devant être autorisées par la Direction de l'Entreprise.
- Tous les **retours de marchandises** doivent être **autorisés** par l'Entreprise. Les **retours** qui ne seront pas dus à des problèmes de qualité devront arriver avec les frais de ports payés et seront remboursés à 90% de la valeur de la marchandise.
- Les **photos, données et mesures** qui apparaissent dans ce catalogue sont à titre indicatif et sont susceptibles de modifications pour exigences techniques ou de production.

### DE

- Die Preise der **vorliegenden Preisliste** annullieren alle vorherigen.
- In den Preisen ist die **VerU.Ventaung** bereits enthalten.
- Das **Transportmittel liegt** im Ermessen dieses Unternehmens. Wenn der Versand durch ein bestimmtes Transportmittel gewünscht wird, das nicht mit dem bei **LACOR** üblichen übereinstimmt, werden die Transportkosten **IN RECHUNG GESTELLT**.
- Die Zahlungsform erfolgt per **EINZUGSVERFAHREN** und das Zahlungsziel beträgt **maximal 60 Tage**. Andere Zahlungsform müssen vor den Geschäftsleitung des Unternehmens genehmigt werden.
- Alle **Retouren von Ware müssen** von der Geschäftsleitung **bewilligt werden**. Die **Retouren**, die nicht Qualitätsprobleme betreffen, müssen mit gezahlten Portokosten geschickt werden. Es werden 90% des Warenwerts zurückerstattet.
- Die in diesem Katalog enthaltenen **Fotos, Informationen und Maße** sind beschreibender Art und können aufgrund technischer oder produktionsbezogener Erfordernisse ohne vorherige Ankündigung geändert werden.

### EN

- Current rate** prices cancel prior rates.
- U.Ventaaging** is included in the prices.
- The **transportation method** shall be selected by this Company. When the delivery is requested through other means than the usual **LACOR**, freight be **DUE**.
- The payment method will be **DIRECT PAYMENT** and the payment terms will be a **máximum of 60 days**. Any other type of payment must be authorized by Company management.
- All **merchandise returns** must be **authorized** by the Company. **Returns** not made due to quality concerns must be delivered with freight paid and will be paid at 90% of the merchandise value.
- Photos, information and measurements** that appear in this catalogue are for information and may be modified due to technical or production requirements at any time.

### PT

- Os preços do **presente tarifário** anulam os anteriores.
- Nos preços estão incluídos as **taxas de embalagem**.
- O **meio de transporte** será à escolha desta Empresa. Quando se desajar o envio por um meio diferente do habitual da **LACOR**, os portes serão **BEVIDOS**.
- A forma de pagamento será a de **PAGAMENTO DOMICILIADO** e o **prazo máximo** para o pagamento será **60 dias**. Outras formas de pagamento deverão ser autorizadas pela Direção da Empresa.
- Todas as **devoluções de mercadorias** têm de ser **autorizadas** pela Empresa. As **devoluções** que não sejam devidas a problemas de qualidade deverão ser enviadas a portes pagos e serão pagas 90% do valor da mercadoria.
- As **fotografias, dados e dimensões** que constam deste catálogo são indicativos e suscetíveis, sem aviso prévio, de alteração por exigências técnicas ou de produção.

Los portes serán **PAGADOS** a partir de los siguientes importes netos mínimos:

- Península y Baleares : **300€**
- Canarias, Ceuta y Melilla: **600€**
- Francia y Alemania: **775€**
- Reino Unido: **700€ / £600**
- Benelux: **1.400€** e Irlanda: **1.200€**
- Italia: **1.500€**
- Para resto de países **consultar**

Les ports seront **PAYÉS** à partir des montants nets suivants de facture minimums:

- Péninsule Ibérique et Baléares : **300€**
- Canaries, Ceuta et Melilla : **600€**
- France et Allemagne : **775€**
- Royaume Uni : **700€ / £600**
- Bénélux: **1.400€** et Irlande : **1.200€**
- Italie : **1.500€**
- Pour le reste des pays, prière de le **consulter**

Die Transportkosten werden ab folgenden Mindestnettoerrechnungsbeträgen von uns **ÜBERNOMMEN**:

- Ibessche Halbinsel und Balearen: **300€**
- Kanaren, Ceuta und Melilla: **600€**
- Frankreich und Deutschland: **775€**
- Vereinigtes Königreich: **700€ / £600**
- Benelux: **1.400€** und Irland: **1.200€**
- Italien: **1.500€**
- Für andere Länder **bitte anfragen**

Freight shall be **PAID** from the following minimum invoice amounts:

- Peninsula and Balearic: **300€**
- Canary Islands, Ceuta and Melilla: **600€**
- France and Germany: **775€**
- United Kingdom: **700€ / £600**
- Benelux: **1.400€** and Ireland: **1.200€**
- Italy: **1.500€**
- For all other countries, please **ask**

Os portes serão **PAGOS** a partir dos seguintes valores líquidos mínimos:

- Península e Ilhas Baleares: **300€**
- Ilhas Canárias, Ceuta e Melilha: **600€**
- França e Alemanha: **775€**
- Reino Unido: **700€ / £600**
- Benelux: **1.400€** e Irlanda: **1.200€**
- Itália: **1.500€**
- Para o resto dos países, **consultar**



**Lacor Menaje Profesional, S.L.**

Bº San Juan, s/n -Apdo. 18

20570 Bergara (Gipuzkoa), Spain

Tel.: (Nacional) 943-76-90-30 / Fax: 943-76-53-87

Tel.: (Export) +34 943-76-91-74 / Fax: +34 943-76-92-22

comercial@lacor.es / export@lacor.es

Grupo Marcos Larrañaga y Cia



[www.lacor.es](http://www.lacor.es)

Ref. 01741

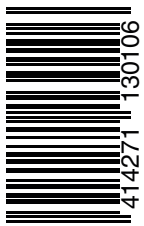

8 414271 130106